

UNIVERSIDAD PRIVADA ANTENOR ORREGO
FACULTAD DE INGENIERÍA
ESCUELA PROFESIONAL DE INGENIERÍA CIVIL



TESIS PARA OPTAR EL TÍTULO PROFESIONAL DE INGENIERO CIVIL

**“PROPUESTA DE DISEÑO DE UNA PRESA PARA
ALMACENAMIENTO Y LAMINACIÓN DE AVENIDAS DEL
RÍO CHICAMA”**

LÍNEA DE INVESTIGACIÓN: HIDRAÚLICA

AUTOR: BR. CASTRO RODRIGUEZ, ADRIAN JESUS

ASESOR: DR. CABANILLAS QUIROZ, GUILLERMO JUAN

TRUJILLO-PERÚ

2021

**“PROPUESTA DE DISEÑO DE UNA PRESA PARA ALMACENAMIENTO Y
LAMINACIÓN DE AVENIDAS DEL RÍO CHICAMA”**

AUTOR:

Br. Castro Rodríguez, Adrián Jesús

APROBADO POR:

**ING. RICARDO ANDRES NARVAEZ ARANDA
PRESIDENTE
CIP:58776**

**ING. JUAN PABLO GARCIA RIVERA
SECRETARIO
CIP:68614**

**ING. OMAR ALEXANDER DAVALOS CAPRISTAN
VOCAL
CIP:72773**

**ING. GUILLERMO JUAN CABANILLAS QUIROZ
ASESOR
CIP: 17902**

DEDICATORIA

Dedico esta investigación principalmente a Dios que día a día me guía por el camino correcto, me bendice y ayuda para lograr los objetivos que me propongo.

A mis padres, José y Margot, por su cariño y apoyo incondicional en cada momento de mi vida y por brindarme las fuerzas necesarias para superar cada obstáculo que se me presenta.

A mis familiares que siempre estuvieron para brindarme sus sabios consejos y así poder lograr un óptimo desarrollo, tanto en mi ámbito personal como profesional.

Bach. Castro Rodríguez, Adrián Jesús

RESUMEN

La presente tesis tiene como objetivo determinar cuál es la mejor propuesta para una presa de laminación en el Río Chicama, cerca de la localidad de Cojitambo, para esto se realizó el estudio topográfico mediante estación total y dron, con lo cual propuse 3 posibles ubicaciones, haciendo el cálculo mediante el software ArcMap y con los cálculos de la Curva Cota-Área-Volumen obteniendo los volúmenes de embalse, 25.71 MMC para la primera propuesta, 16.88 MMC en la segunda propuesta y 18.68 MMC para la tercera propuesta.

También se hizo un análisis de caudales, haciendo uso de información recopilada desde la página del Senamhi, el registro que encontré es el de caudales diarios de 48 años, comprendidos entre los años de 1971 y 2018; calculando un caudal promedio diario de 286.08 (m³/s), también pudimos registrar una máxima de 1416.73 (m³/s) que ocurrió en el año 1998 y una mínima de 37.24 (m³/s) en el año 2018.

Para el cálculo de la intensidad de lluvia, tuvimos que recopilar algunos datos del registro de precipitaciones diarias de la estación Huamachuco, que está ubicada a una cota de 3290 m.s.n.m., ubicada en la zona Sierra en la subzona 5-a8 con lo cual mediante el software Hydroiila calculamos las precipitaciones en los 170 minutos de lluvia, con intervalos de 5 minutos, calculado para un periodo de retorno igual a 100 años, con estos resultados podemos ingresar al software Hec Hms para calcular el caudal de entrada, habiendo calculado un caudal pico de 1565.40 (m³/s).

Posteriormente definimos las características de la presa de la propuesta que elegimos como la más favorable de las 3, en este caso es la que embalsa un volumen de 25.71 MMC, con una longitud de 366.91 metros, la altura de la presa es de 32 metros, también calculamos la longitud del aliviadero que es de 50 metros, 9 metros de ancho en la corona del aliviadero y una altura de 3 metros; con esto conseguiremos una laminación de 1161.68 (m³/s). Siendo una presa de tierra con núcleo de arcilla (Material Impermeable), con espaldones de talud 2:1 (H:V) tanto en aguas arriba como aguas abajo.

ABSTRACT

The objective of this thesis is to determine which is the best proposal for a rolling dam in the Chicama river, near the town of Cojitambo, for this the topographic study was carried out using a total station and drone, with which I proposed 3 possible locations, doing the calculation using the ArcMap software and with the calculations of the Elevation-Area-Volume Curve obtaining the reservoir volumes, 25.71 MMC for the first proposal, 16.88 MMC in the second proposal and 18.68 MMC for the third proposal.

A flow analysis was also made, using information collected from the Senamhi page, the record I found is the daily flows of 48 years, between the years 1971 and 2018; Calculating an average daily flow of 286.08 (m³ / s), we were also able to record a maximum of 1416.73 (m³ / s) that occurred in 1998 and a minimum of 37.24 (m³ / s) in 2018.

To calculate the intensity of rain, we had to collect some data from the daily rainfall record of the Huamachuco station, which is located at a height of 3,290 meters above sea level, located in the Sierra area in subzone 5-a8, whereby by means of the Hydroiila software we calculate the precipitations in the 170 minutes of rain, with intervals of 5 minutes, calculated for a return period equal to 100 years, with these results we can enter the Hec Hms software to calculate the inlet flow, having calculated a peak flow 1565.40 (m³ / s).

Later we defined the characteristics of the dam of the proposal that we chose as the most favorable of the 3, in this case it is the one that impounds a volume of 25.71 MMC, with a length of 366.91 meters, the height of the dam is 32 meters, We also calculate the length of the spillway which is 50 meters, 9 meters wide at the spillway crown and a height of 3 meters; With this we will achieve a lamination of 1161.68 (m³ / s). Being a clay core earthen dam (Waterproof Material), with 2: 1 (H: V) slope shoulders both upstream and downstream.

PRESENTACIÓN

Señores miembros del jurado:

De conformidad y en cumplimiento de los requisitos estipulados en el reglamento de Grados y Títulos de la Universidad Privada Antenor Orrego y el reglamento interno de la Escuela Profesional de Ingeniería Civil, pongo a vuestra disposición el presente trabajo de suficiencia profesional titulado: PROPUESTA DE DISEÑO DE UNA PRESA PARA ALMACENAMIENTO Y LAMINACIÓN DE AVENIDAS DEL RÍO CHICAMA.

Para obtener el título profesional de ingeniero civil, así como algunas experiencias para el desarrollo de la ingeniería.

Considero señores miembros del jurado que con vuestras sugerencias y recomendaciones este trabajo pueda mejorarse y contribuir a la difusión de la investigación de nuestra Universidad.

INDICE DE CONTENIDOS

I. INTRODUCCIÓN	1
1.1. Problemas de Investigación	1
a. Descripción de la Realidad Problemática	1
b. Formulación del problema	1
1.2. Objetivos	1
1.2.1. Objetivo General	1
1.2.2. Objetivos Específicos	1
1.3. Justificación del Estudio	2
II. MARCO DE REFERENCIA	3
2.1. Antecedentes del Estudio	3
2.2. Marco Teórico	7
2.2.1. Modelo Digital de Elevación (DEM)	7
2.2.1.1. Levantamiento Topográfico	7
2.2.1.1.1. Herramientas	7
A. Estación Total	7
B. Drone	8
2.2.1.1.2. Etapas	8
A. Planificación.....	8
B. Señalización	8
C. Ejecución del Vuelo con Drone.....	9
D. Captura de Datos.....	10
2.2.1.2. Procesamientos de Datos y Generación del DEM	10
2.2.1.2.1. Softwares	10
A. Agisoft Photoscan.....	10
B. AutoCAD Civil 3D	10
2.2.1.2.2. Etapas	11
A. Importación de imágenes.....	11
B. Orientación de imágenes	11
C. Orientación absoluta	11
D. Creación de Nube de Puntos Densa	11
E. Creación de Malla.....	12
F. Creación de Textura	12
G. Creación de Ortomosaico	12
2.2.2. Estudio Hidrológico	13

2.2.2.1.	Curva de Caudales Clasificados	13
2.2.2.2.	Avenidas y aguas altas	13
2.2.2.3.	Caudal Dominante o Formativo de cauce (Bankfull Discharge)	13
2.2.2.4.	Análisis Estadísticos de Datos Hidrológicos	15
2.2.2.4.1.	Análisis de Consistencia	15
A.	Análisis visual gráfico	15
B.	Análisis doble masa	15
C.	Análisis Estadístico	16
2.2.2.4.2.	Parámetros Estadísticos	16
A.	Media	16
B.	Varianza	16
C.	Desviación Estándar	17
D.	Coficiente de Variación	17
E.	Coficiente de Asimetría	17
2.2.2.4.3.	Periodo de Retorno	18
2.2.2.4.4.	Intervalo de Confianza	19
2.2.2.4.5.	Modelo de Distribución	19
a)	Distribución Normal	19
b)	Distribución Log Normal 2 parámetros	20
c)	Distribución Log Normal 3 parámetros	21
d)	Distribución Gamma 2 parámetros	21
e)	Distribución Gamma 3 parámetros	22
f)	Distribución Log Pearson tipo III	22
g)	Distribución Gumbel	23
h)	Distribución Log Gumbel	24
2.2.2.4.6.	Prueba de Bondad de Ajuste	24
A)	X ²	24
B)	Prueba Kolmogorov – Smirnov	25
2.2.3.	Hidráulica Fluvial	27
2.2.3.1.	Morfología de un río	27
2.2.3.1.1.	Perfil Longitudinal	27
2.2.3.1.2.	Estado de Equilibrio	28
2.2.3.1.3.	Llanuras de Inundación	28
2.2.3.2.	Clasificación de los ríos	28
2.2.3.2.1.	Por su edad	29
A)	Ríos Jóvenes	29

B)	Ríos Maduros	29
C)	Ríos Viejos	29
2.2.3.2.2.	Por su Morfología	30
A)	Ríos Rectos	30
B)	Ríos Entrelazados	31
C)	Ríos Meándricos.....	31
2.2.3.2.3.	Por su Pendiente.....	32
A)	Ríos Torrenciales	32
B)	Ríos Torrentes	32
2.2.3.3.	Inundación.....	32
2.2.3.3.1.	Tipos	33
A)	Inundación Estática	33
B)	Inundación Dinámica	33
2.2.3.4.	Tipos de Flujos	33
2.2.3.4.1.	Criterio de Tiempo	33
A)	Flujo Permanente	33
B)	Flujo No Permanente	34
2.2.3.4.2.	Criterio de Espacio	34
A)	Flujo Uniforme	34
B)	Flujo Variado.....	34
2.2.3.4.3.	Criterio de Viscosidad.....	34
A)	Flujo Laminar	34
B)	Flujo Turbulento	35
C)	Flujo Transicional.....	35
2.2.3.4.4.	Criterio de N° Froude (Fr)	35
A)	Flujo Subcrítico	35
B)	Flujo Crítico.....	35
C)	Flujo Supercrítico.....	35
2.2.3.4.5.	Criterio de Velocidad.....	35
A)	Flujo Unidimensional.....	35
B)	Flujo Bidimensional	36
C)	Flujo Tridimensional	36
2.2.4.	Software	36
2.2.4.1.	Generación del Modelo Digital de Elevación (DEM)	36
2.2.4.1.1.	AutoCAD Civil 3D 2019.....	36
2.2.4.1.2.	Agisoft Photoscan	36

2.2.4.1.3. ArcGis 10.2.2.....	36
2.2.4.2. Estudio Hidrológico	37
2.2.4.2.1. Aplicación del HYDROIIA.	37
2.3. Marco Conceptual	38
2.4. Hipótesis.....	39
2.4.1. General	39
2.5. Variables	39
2.5.1. Variable Independiente	39
2.5.2. Variable Dependiente	39
2.6. Operacionalización de Variables	39
III. METODOLOGÍA EMPLEADA	40
3.1. Tipo y Nivel de Investigación	40
3.1.1. Tipo de Investigación.....	40
3.1.2. Nivel de Investigación.....	40
3.2. Población y Muestra de Estudio	40
3.2.1. Población	40
3.2.2. Muestra.....	40
3.3. Diseño de Investigación.....	40
3.4. Técnicas e instrumentos de Recolección de Datos	40
3.5. Procesamiento y Análisis de Datos	41
IV. RESULTADOS.....	42
4.1. Modelo Digital de Elevación (DEM)	42
4.2. Modelo del Embalse.....	42
4.2.1. Propuesta 1.....	43
4.2.2. Propuesta 2.....	53
4.2.3. Propuesta 3.....	63
4.3. Curva Cota – Área – Volumen	73
4.3.1. Embalse 1.....	73
4.3.2. Embalse 2.....	89
4.3.3. Embalse 3.....	105
4.3.4. Cuadro Resumen para Coeficientes obtenidos de la Línea de Tendencia.....	121
4.4. Estudio Hidrológico	122
4.4.1. Análisis de Caudales.....	122
4.4.2. Cuadro Resumen de Caudales Promedio Diario por Año.....	123
4.4.3. Intensidad de Lluvia	124
4.4.4. Cálculo del Caudal de Entrada	129

4.5. Elección de la Mejor Propuesta	149
4.5.1. Condiciones.....	149
4.5.2. Cuadro Resumen	149
4.5.3. Elección.....	149
4.6. Cálculo del Caudal Laminado	150
4.6.1. Tránsito de Avenidas	150
4.7. Longitud de Aliviadero	177
4.7.1. Cuadro Resumen	177
4.8. Ancho de la Corona	178
4.9. Borde Libre.....	178
4.10. Espaldones.....	178
4.11. Núcleo Impermeable	179
4.11.1. Base del Núcleo Impermeable	179
4.11.2. Corona del Núcleo Impermeable	179
4.11.3. Talud del Núcleo Impermeable	179
4.12. Cuerpo Estabilizador	179
4.12.1. Talud del Cuerpo estabilizador.....	179
4.13. Filtros	179
4.14. Dren	179
4.15. Sección Transversal de la Presa de Tierra con Núcleo de Arcilla.....	180
4.15.1. Zonificación	180
4.15.2. Dimensiones y Taludes.....	181
4.15.3. Materiales	182
CONCLUSIONES	183
BIBLIOGRAFÍA:	184
ANEXOS.....	186

INDICE DE TABLAS

Tabla 1: Operacionalización de Variables - Variable Independiente	39
Tabla 2: Operacionalización de Variables - Variable Dependiente	39
Tabla 3: Cálculos de Volumen Acumulado del Embalse 1	73
Tabla 4: Coeficiente para el Cálculo de Volumen Aliviado para L=25m.....	75
Tabla 5: Volumen Aliviado para L=25m.....	75
Tabla 6: Coeficiente para el Cálculo de Volumen Aliviado para L=50m.....	76
Tabla 7: Volumen Aliviado para L=50m.....	76
Tabla 8: Coeficiente para el Cálculo de Volumen Aliviado para L=75m.....	77
Tabla 9: Volumen Aliviado para L=75m.....	77
Tabla 10: Coeficiente para el Cálculo de Volumen Aliviado para L=100m.....	78
Tabla 11: Volumen Aliviado para L=100m.....	78
Tabla 12: Coeficiente para el Cálculo de Volumen Aliviado para L=125m.....	79
Tabla 13: Volumen Aliviado para L=125m.....	79
Tabla 14: Coeficiente para el Cálculo de Volumen Aliviado para L=150m.....	80
Tabla 15: Volumen Aliviado para L=150m.....	80
Tabla 16: Coeficiente para el Cálculo de Volumen Aliviado para L=175m.....	81
Tabla 17: Volumen Aliviado para L=175m.....	81
Tabla 18: Coeficiente para el Cálculo de Volumen Aliviado para L=200m.....	82
Tabla 19: Volumen Aliviado para L=200m.....	82
Tabla 20: Coeficiente para el Cálculo de Volumen Aliviado para L=225m.....	83
Tabla 21: Volumen Aliviado para L=225m.....	83
Tabla 22: Coeficiente para el Cálculo de Volumen Aliviado para L=250m.....	84
Tabla 23: Volumen Aliviado para L=250m.....	84
Tabla 24: Coeficiente para el Cálculo de Volumen Aliviado para L=275m.....	85
Tabla 25: Volumen Aliviado para L=275m.....	85
Tabla 26: Coeficiente para el Cálculo de Volumen Aliviado para L=300m.....	86
Tabla 27: Volumen Aliviado para L=300m.....	86
Tabla 28: Coeficiente para el Cálculo de Volumen Aliviado para L=325m.....	87
Tabla 29: Volumen Aliviado para L=325m.....	87
Tabla 30: Coeficiente para el Cálculo de Volumen Aliviado para L=350m.....	88
Tabla 31: Volumen Aliviado para L=350m.....	88
Tabla 32: Cálculos de Volumen Acumulado del Embalse 2	89
Tabla 33: Coeficiente para el Cálculo de Volumen Aliviado para L=25m.....	91
Tabla 34: Volumen Aliviado para L=25m.....	91
Tabla 35: Coeficiente para el Cálculo de Volumen Aliviado para L=50m.....	92

Tabla 36: Volumen Aliviado para L=50m	92
Tabla 37: Coeficiente para el Cálculo de Volumen Aliviado para L=75m.....	93
Tabla 38: Volumen Aliviado para L=75m	93
Tabla 39: Coeficiente para el Cálculo de Volumen Aliviado para L=100m.....	94
Tabla 40: Volumen Aliviado para L=100m	94
Tabla 41: Coeficiente para el Cálculo de Volumen Aliviado para L=125m.....	95
Tabla 42: Volumen Aliviado para L=125m	95
Tabla 43: Coeficiente para el Cálculo de Volumen Aliviado para L=150m.....	96
Tabla 44: Volumen Aliviado para L=150m	96
Tabla 45: Coeficiente para el Cálculo de Volumen Aliviado para L=175m.....	97
Tabla 46: Volumen Aliviado para L=175m	97
Tabla 47: Coeficiente para el Cálculo de Volumen Aliviado para L=200m.....	98
Tabla 48: Volumen Aliviado para L=200m	98
Tabla 49: Coeficiente para el Cálculo de Volumen Aliviado para L=225m.....	99
Tabla 50: Volumen Aliviado para L=225m	99
Tabla 51: Coeficiente para el Cálculo de Volumen Aliviado para L=250m.....	100
Tabla 52: Volumen Aliviado para L=250m	100
Tabla 53: Coeficiente para el Cálculo de Volumen Aliviado para L=275m.....	101
Tabla 54: Volumen Aliviado para L=275m	101
Tabla 55: Coeficiente para el Cálculo de Volumen Aliviado para L=300m.....	102
Tabla 56: Volumen Aliviado para L=300m	102
Tabla 57: Coeficiente para el Cálculo de Volumen Aliviado para L=325m.....	103
Tabla 58: Volumen Aliviado para L=325m	103
Tabla 59: Coeficiente para el Cálculo de Volumen Aliviado para L=350m.....	104
Tabla 60: Volumen Aliviado para L=350m	104
Tabla 61: Cálculos de Volumen Acumulado del Embalse 3	105
Tabla 62: Coeficiente para el Cálculo de Volumen Aliviado para L=25m.....	107
Tabla 63: Volumen Aliviado para L=25m	107
Tabla 64: Coeficiente para el Cálculo de Volumen Aliviado para L=50m.....	108
Tabla 65: Volumen Aliviado para L=50m	108
Tabla 66: Coeficiente para el Cálculo de Volumen Aliviado para L=75m.....	109
Tabla 67: Volumen Aliviado para L=75m	109
Tabla 68: Coeficiente para el Cálculo de Volumen Aliviado para L=100m.....	110
Tabla 69: Volumen Aliviado para L=100m	110
Tabla 70: Coeficiente para el Cálculo de Volumen Aliviado para L=125m.....	111
Tabla 71: Volumen Aliviado para L=125m	111
Tabla 72: Coeficiente para el Cálculo de Volumen Aliviado para L=150m.....	112

Tabla 73: Volumen Aliviado para L=150m.....	112
Tabla 74: Coeficiente para el Cálculo de Volumen Aliviado para L=175m.....	113
Tabla 75: Volumen Aliviado para 175m	113
Tabla 76: Coeficiente para el Cálculo de Volumen Aliviado para L=200m.....	114
Tabla 77: Volumen Aliviado para L=200m.....	114
Tabla 78: Coeficiente para el Cálculo de Volumen Aliviado para L=225m.....	115
Tabla 79: Volumen Aliviado para L=225m.....	115
Tabla 80: Coeficiente para el Cálculo de Volumen Aliviado para L=250m.....	116
Tabla 81: Volumen Aliviado para L=250m.....	116
Tabla 82: Coeficiente para el Cálculo de Volumen Aliviado para L=275m.....	117
Tabla 83: Volumen Aliviado para L=275m.....	117
Tabla 84: Coeficiente para el Cálculo de Volumen Aliviado para L=300m.....	118
Tabla 85: Volumen Aliviado para L=300m.....	118
Tabla 86: Coeficiente para el Cálculo de Volumen Aliviado para L=325m.....	119
Tabla 87: Volumen Aliviado para L=325m.....	119
Tabla 88: Coeficiente para el Cálculo de Volumen Aliviado para L=350m.....	120
Tabla 89: Volumen Aliviado para L=350m.....	120
Tabla 90: Cuadro Resumen de Coeficiente obtenidos de la Línea de Tendencia del Embalse 1.....	121
Tabla 91: Cuadro Resumen de Coeficiente obtenidos de la Línea de Tendencia del Embalse 2.....	121
Tabla 92: Cuadro Resumen de Coeficiente obtenidos de la Línea de Tendencia del Embalse 3.....	122
Tabla 93: Cuadro Resumen de Caudales Promedio Diario por Año.....	123
Tabla 94: Resultados del Hydroiila	127
Tabla 95: Datos de las Subcuencas.....	129
Tabla 96: Distribución de probabilidades pluviométricas mediante Gumbel.....	136
Tabla 97: Cálculo de Variable Probabilísticas	137
Tabla 98: Fórmulas para el cálculo de las Precipitaciones Diarias máximas probables para distintas frecuencias	137
Tabla 99: cálculo de las Precipitaciones Diarias máximas probables para distintas frecuencias.....	137
Tabla 100: Cuadro Resumen de las Propuestas.....	149
Tabla 101: Coeficientes de línea de tendencia para L=25m	150
Tabla 102: Cálculos del Tránsito de Avenidas para L=25m.....	150
Tabla 103: Coeficientes de línea de tendencia para L=50m	151
Tabla 104: Cálculos del Tránsito de Avenidas para L=50m.....	151

Tabla 105: Coeficientes de línea de tendencia para L=75m	153
Tabla 106: Cálculos del Tránsito de Avenidas para L=75m.....	153
Tabla 107: Coeficientes de línea de tendencia para L=100m	155
Tabla 108: Cálculos del Tránsito de Avenidas para L=100m.....	155
Tabla 109: Coeficientes de línea de tendencia para L=125m	157
Tabla 110: Cálculos del Tránsito de Avenidas para L=125m.....	157
Tabla 111: Coeficientes de línea de tendencia para L=150m	159
Tabla 112: Cálculos del Tránsito de Avenidas para L=150m.....	159
Tabla 113: Coeficientes de línea de tendencia para L=175m	161
Tabla 114: Cálculos del Tránsito de Avenidas para L=175m.....	161
Tabla 115: Coeficientes de línea de tendencia para L=200m	163
Tabla 116: Cálculos del Tránsito de Avenidas para L=200m.....	163
Tabla 117: Coeficientes de línea de tendencia para L=225m	165
Tabla 118: Cálculos del Tránsito de Avenidas para L=225m.....	165
Tabla 119: Coeficientes de línea de tendencia para L=250m	167
Tabla 120: Cálculos del Tránsito de Avenidas para L=250m.....	167
Tabla 121: Coeficientes de línea de tendencia para L=275m	169
Tabla 122: Cálculos del Tránsito de Avenidas para L=275m.....	169
Tabla 123: Coeficientes de línea de tendencia para L=300m	171
Tabla 124: Cálculos del Tránsito de Avenidas para L=300m.....	171
Tabla 125: Coeficientes de línea de tendencia para L=325m	173
Tabla 126: Cálculos del Tránsito de Avenidas para L=325m.....	173
Tabla 127: Coeficientes de línea de tendencia para L=350m	175
Tabla 128: Cálculos del Tránsito de Avenidas para L=350m.....	175
Tabla 129: Cuadro Resumen del Q_{máx} Laminado	177
Tabla 130: Ancho de la Corona en diferentes métodos.....	178
Tabla 131: Pendientes recomendadas de los Taludes para los Espaldones.....	178
Tabla 132: Zonas de la sección transversal.....	180

INDICE DE ILUSTRACIÓN

Ilustración 1 - Relación entre descarga dominante y descarga media (Chang 1979). Fuente: Apacla, 2014.....	15
Ilustración 2 - Ejemplo de Perfil Longitudinal de un Río. (Pérez, Rodríguez, & Molina, 2018)	27
Ilustración 3 - Estado de Equilibrio. En el tramo 1-2 no hay erosión ni sedimentación (TF1 =TF2) (Vide, 2002)	28
Ilustración 4 - Llanuras de inundación. (Vide, 2002)	28
Ilustración 5 - Río Recto. (Pérez, Rodríguez, & Molina, 2018)	30
Ilustración 6 - Ríos Entrelazados (Pérez, Rodríguez, & Molina, 2018).....	31
Ilustración 7 - Ríos Meándricos. (Pérez, Rodríguez, & Molina, 2018)	32
Ilustración 8: Ubicación de embalses.....	42
Ilustración 9: Curvas de Nivel de Embalse 1	43
Ilustración 10: Longitud de la Presa 1	44
Ilustración 11: Contorno del Embalse 1	45
Ilustración 12: Espejo de Agua del Embalse 1	46
Ilustración 13: TIN del Embalse 1.....	47
Ilustración 14: Raster del Embalse 1	48
Ilustración 15: Reclasificación de Alturas del Embalse 1.....	49
Ilustración 16: Reclasificación con Altura de 1m del Embalse 1	50
Ilustración 17: Dissolve del Embalse 1.....	51
Ilustración 18: Tabla de Atributos del Embalse 1	52
Ilustración 19: Curvas de Nivel de Embalse 2	53
Ilustración 20: Longitud de la Presa 2	54
Ilustración 21: Contorno del Embalse 2	55
Ilustración 22: Espejo de Agua del Embalse 2	56
Ilustración 23: TIN del Embalse 2.....	57
Ilustración 24: Raster del Embalse 2	58
Ilustración 25: Reclasificación de Alturas del Embalse 2.....	59
Ilustración 26: Reclasificación con Altura de 1m del Embalse 2	60
Ilustración 27: Dissolve del Embalse 2.....	61
Ilustración 28: Tabla de Atributos del Embalse 2.....	62
Ilustración 29: Curvas de Nivel del Embalse 3	63
Ilustración 30: Longitud de la Presa 3.....	64
Ilustración 31: Contorno del Embalse 3	65
Ilustración 32: Espejo de Agua del Embalse 3	66

Ilustración 33: TIN del Embalse 3.....	67
Ilustración 34: Raster del Embalse 3	68
Ilustración 35: Reclasificación de Alturas del Embalse 3.....	69
Ilustración 36: Reclasificación con Altura de 1m del Embalse 3	70
Ilustración 37: Dissolve del Embalse 3.....	71
Ilustración 38: Tabla de Atributos del Embalse 3.....	72
Ilustración 39: Límites de Zonas y Sub Zonas que nos brinda el software Hydroiila	124
Ilustración 40: Elección de la Zona y Subzona.....	125
Ilustración 41: Cálculo en Hydroiila.....	126
Ilustración 42: Crear "New Project"	129
Ilustración 43: Crear "Basin Model"	129
Ilustración 44: "Basin Model" creado.....	130
Ilustración 45: Crear "New Subbasin"	130
Ilustración 46: "Subbasin" creado	131
Ilustración 47: Rellenando los elementos de "Subbasin-1"	131
Ilustración 48: Rellenar los datos de la Pestaña "Loss"	132
Ilustración 49: Rellenar los datos de la Pestaña "Transform"	133
Ilustración 50: Crear "Meteorologic Models"	133
Ilustración 51: "Meteorologic Models" creado	134
Ilustración 52: Rellenar los datos de la Pestaña "Meteorologic Models"	134
Ilustración 53: Rellenar los datos de la Pestaña "Basin 1"	135
Ilustración 54: Rellenar los datos de la Pestaña "Options"	135
Ilustración 55: Crear "Control Specifications"	138
Ilustración 56: "Control Specifications" creado	138
Ilustración 57: Rellenar con los datos los elementos de "Control 1".....	139
Ilustración 58: Crear "Time - Series Data"	139
Ilustración 59: "Time - Series Data" creado	140
Ilustración 60: Rellenar los datos de la Pestaña "Time - Series Gage"	140
Ilustración 61: Rellenar los datos de la Pestaña "Time Window"	141
Ilustración 62: Rellenar los datos de la Pestaña "Table".....	141
Ilustración 63: Rellenar los datos de la Pestaña "Specified Hyetograph"	142
Ilustración 64: Crear la simulación	142
Ilustración 65: Nombre para la simulación	143
Ilustración 66: Seleccionar "Basin 1" para la Simulación	143
Ilustración 67: Seleccionar "Met 1" para la Simulación.....	144
Ilustración 68: Seleccionar "Control 1" para la Simulación	144

Ilustración 69: Ejecutar la simulación	145
Ilustración 70: Activación del ícono "Compute All Elements"	145
Ilustración 71: Progreso de la simulación.....	146
Ilustración 72: "View Global Summary Table"	146
Ilustración 73: "View Graph for Select Elements"	147
Ilustración 74: "View Summary Table for Select Elements"	147
Ilustración 75: Resultados del Caudal de Entrada	148
Ilustración 76: Sección Transversal de Presa con Núcleo Impermeable de Arcilla	180
Ilustración 77: Dimensiones y taludes de la Presa Impermeable con Núcleo de Arcilla.....	181
Ilustración 78: Materiales de la Presa Impermeable con Núcleo de Arcilla	182
Ilustración 79: Materiales usado según zona de la Presa Impermeable con Núcleo de Arcilla.....	182
Ilustración 80: Registro de Descarga Diaria del Año 1971	187
Ilustración 81: Registro de Descarga Diaria del Año 1972	188
Ilustración 82: Registro de Descarga Diaria del Año 1973	189
Ilustración 83: Registro de Descarga Diaria del Año 1974	190
Ilustración 84: Registro de Descarga Diaria del Año 1975	191
Ilustración 85: Registro de Descarga Diaria del Año 1976	192
Ilustración 86: Registro de Descarga Diaria del Año 1977	193
Ilustración 87: Registro de Descarga Diaria del Año 1978	194
Ilustración 88: Registro de Descarga Diaria del Año 1979	195
Ilustración 89: Registro de Descarga Diaria del Año 1980	196
Ilustración 90: Registro de Descarga Diaria del Año 1981	197
Ilustración 91: Registro de Descarga Diaria del Año 1982	198
Ilustración 92: Registro de Descarga Diaria del Año 1983	199
Ilustración 93: Registro de Descarga Diaria del Año 1984	200
Ilustración 94: Registro de Descarga Diaria del Año 1985	201
Ilustración 95: Registro de Descarga Diaria del Año 1986	202
Ilustración 96: Registro de Descarga Diaria del Año 1987	203
Ilustración 97: Registro de Descarga Diaria del Año 1988	204
Ilustración 98: Registro de Descarga Diaria del Año 1989	205
Ilustración 99: Registro de Descarga Diaria del Año 1990	206
Ilustración 100: Registro de Descarga Diaria del Año 1991	207
Ilustración 101: Registro de Descarga Diaria del Año 1992	208
Ilustración 102: Registro de Descarga Diaria del Año 1993	209
Ilustración 103: Registro de Descarga Diaria del Año 1994	210

Ilustración 104: Registro de Descarga Diaria del Año 1995	211
Ilustración 105: Registro de Descarga Diaria del Año 1996	212
Ilustración 106: Registro de Descarga Diaria del Año 1997	213
Ilustración 107: Registro de Descarga Diaria del Año 1998	214
Ilustración 108: Registro de Descarga Diaria del Año 1999	215
Ilustración 109: Registro de Descarga Diaria del Año 2000	216
Ilustración 110: Registro de Descarga Diaria del Año 2001	217
Ilustración 111: Registro de Descarga Diaria del Año 2002	218
Ilustración 112: Registro de Descarga Diaria del Año 2003	219
Ilustración 113: Registro de Descarga Diaria del Año 2004	220
Ilustración 114: Registro de Descarga Diaria del Año 2005	221
Ilustración 115: Registro de Descarga Diaria del Año 2006	222
Ilustración 116: Registro de Descarga Diaria del Año 2007	223
Ilustración 117: Registro de Descarga Diaria del Año 2008	224
Ilustración 118: Registro de Descarga Diaria del Año 2009	225
Ilustración 119: Registro de Descarga Diaria del Año 2010	226
Ilustración 120: Registro de Descarga Diaria del Año 2011	227
Ilustración 121: Registro de Descarga Diaria del Año 2012	228
Ilustración 122: Registro de Descarga Diaria del Año 2013	229
Ilustración 123: Registro de Descarga Diaria del Año 2014	230
Ilustración 124: Registro de Descarga Diaria del Año 2015	231
Ilustración 125: Registro de Descarga Diaria del Año 2016	232
Ilustración 126: Registro de Descarga Diaria del Año 2017	233
Ilustración 127: Registro de Descarga Diaria del Año 2018	234

INDICE DE GRÁFICOS

Gráfico 1: Curva Cota - Área - Volumen del Embalse 1	74
Gráfico 2: N vs Q para L=25m	75
Gráfico 3: N vs Q para L=50m	76
Gráfico 4: N vs Q para L=75m	77
Gráfico 5: N vs Q para L=100m	78
Gráfico 6: N vs Q para L=125m	79
Gráfico 7: N vs Q para L=150m	80
Gráfico 8: N vs Q para L=175m	81
Gráfico 9: N vs Q para L=200m	82
Gráfico 10: N vs Q para L=225m	83
Gráfico 11: N vs Q para L=250m	84
Gráfico 12: N vs Q para L=275m	85
Gráfico 13: N vs Q para L=300m	86
Gráfico 14: N vs Q para L=325m	87
Gráfico 15: N vs Q para L=350m	88
Gráfico 16: Curva Cota - Área - Volumen del Embalse 2	90
Gráfico 17: N vs Q para L=25m	91
Gráfico 18: N vs Q para L=50m	92
Gráfico 19: N vs Q para L=75m	93
Gráfico 20: N vs Q para L=100m	94
Gráfico 21: N vs Q para L=125m	95
Gráfico 22: N vs Q para L=150m	96
Gráfico 23: N vs Q para L=175m	97
Gráfico 24: N vs Q para L=200m	98
Gráfico 25: N vs Q para L=225m	99
Gráfico 26: N vs Q para L=250m	100
Gráfico 27: N vs Q para L=275m	101
Gráfico 28: N vs Q para L=300m	102
Gráfico 29: N vs Q para L=325m	103
Gráfico 30: N vs Q para L=350m	104
Gráfico 31: Curva Cota - Área - Volumen del Embalse 3	106
Gráfico 32: N vs Q para L=25m	107
Gráfico 33: N vs Q para L=50m	108
Gráfico 34: N vs Q para L=75m	109
Gráfico 35: N vs Q para L=100m	110

Gráfico 36: N vs Q para L=125m	111
Gráfico 37: N vs Q para L=150m	112
Gráfico 38: N vs Q para L=175m	113
Gráfico 39: N vs Q para L=200m	114
Gráfico 40: N vs Q para L=225m	115
Gráfico 41: N vs Q para L=250m	116
Gráfico 42: N vs Q para L=275m	117
Gráfico 43: N vs Q para L=300m	118
Gráfico 44: N vs Q para L=325m	119
Gráfico 45: N vs Q para L=350m	120
Gráfico 46: Hietograma de la Intensidad de Lluvia	128
Gráfico 47: Curva IDF	128
Gráfico 48: Gráfico de Caudal de Entrada vs Caudal Laminado para L=50m.....	152
Gráfico 49: Gráfico de Caudal de Entrada vs Caudal Laminado para L=75m.....	154
Gráfico 50: Gráfico de Caudal de Entrada vs Caudal Laminado para L=100m.....	156
Gráfico 51: Gráfico de Caudal de Entrada vs Caudal Laminado para L=125m.....	158
Gráfico 52: Gráfico de Caudal de Entrada vs Caudal Laminado para L=150m.....	160
Gráfico 53: Gráfico de Caudal de Entrada vs Caudal Laminado para L=175m.....	162
Gráfico 54: Gráfico de Caudal de Entrada vs Caudal Laminado para L=200m.....	164
Gráfico 55: Gráfico de Caudal de Entrada vs Caudal Laminado para L=225m.....	166
Gráfico 56: Gráfico de Caudal de Entrada vs Caudal Laminado para L=250m.....	168
Gráfico 57: Gráfico de Caudal de Entrada vs Caudal Laminado para L=275m.....	170
Gráfico 58: Gráfico de Caudal de Entrada vs Caudal Laminado para L=300m.....	172
Gráfico 59: Gráfico de Caudal de Entrada vs Caudal Laminado para L=325m.....	174
Gráfico 60: Gráfico de Caudal de Entrada vs Caudal Laminado para L=350m.....	176

I. INTRODUCCIÓN

1.1. Problemas de Investigación

a. Descripción de la Realidad Problemática

El Valle Chicama presenta un déficit hídrico importante, lo cual afecta al desarrollo fisiológico de los cultivos y por consiguiente el lento crecimiento de esta zona, ya que la agricultura es la principal actividad que se realiza.

Con la finalidad de mejorar y dar solución a este problema se plantea una propuesta de diseño para una presa de almacenamiento y laminación de avenidas del Río Chicama, la cual se ubicaría a unos pocos kilómetros de la localidad de Cojitambo, almacenaría aproximadamente 25 MMC de agua, con el propósito de regular las aguas del Río Chicama y almacenar recursos hídricos para épocas de estiaje, abasteciendo el riego de varios miles de hectáreas de cultivo.

Las características y funcionamiento de esta presa tienen un valor muy importante desde el punto de vista productivo, ya que ayuda a que la zona pueda desarrollarse de la mejor manera social y económicamente, para esto la presa debe presentar el cumplimiento de algunas leyes físicas y geológicas para su buen funcionamiento.

b. Formulación del problema

¿Cuál será la mejor propuesta de diseño para una presa de almacenamiento y laminación de avenidas del Río Chicama?

1.2. Objetivos

1.2.1. Objetivo General

- Proponer un diseño para una presa de almacenamiento y laminación de avenidas del Río Chicama.

1.2.2. Objetivos Específicos

- Realizar el estudio de Topografía.
- Analizar los caudales del Río Chicama.

- Definir las características de la Presa.

1.3. Justificación del Estudio

El Valle Chicama es un gran sector agrícola, el cual se ve perjudicado de manera directa por la falta de recurso hídrico en tiempos de estiaje, la construcción de esta presa sería un proyecto que solucionaría este problema, para ello debemos realizar los estudios correspondientes y conseguir el mejor diseño posible.

II. MARCO DE REFERENCIA

2.1. Antecedentes del Estudio

Se han realizado investigaciones parecidas a esta, las cuales pueden ayudar de gran forma en el proceso de este proyecto, algunos estudios son:

- FLORES (2018). En su investigación: “Diseño hidráulico de una presa de enrocado con pantalla de concreto para reducir el déficit hídrico de la C.H. San Gabán II en época de estiaje”. Nos dice que la investigación se enfoca en el diseño hidráulico de una presa de enrocado con pantalla de concreto, ubicado en el cañón principal del río Ninahuisa, afluente del río Macusani; que suministrará agua regulada en época de estiaje a la C.H. San Gabán II. La variabilidad de caudales del río Ollachea, muestra un superávit hídrico durante cinco meses y déficit hídrico durante siete meses. Esta condición impide alcanzar el caudal de diseño de 19 m³/s, causando el déficit hídrico de la C.H. San Gabán II en época de estiaje. El diseño de la investigación está formado por una fase teórica y una fase de comprobación de actividades, basados en un enfoque cuantitativo a través de una investigación causi-experimental. En la presa se realizaron 3 perforaciones diamantinas con ensayos de permeabilidad del tipo Lugeon y su cimentación se encuentra en roca relativamente competente con capacidad suficiente para soportar las estructuras propuestas, sin embargo, los valores de permeabilidad encontrados no garantizan la impermeabilidad de los mismos. Para ello, se propone la ejecución de una pantalla de inyecciones de impermeabilización debajo del plinto de la presa. El déficit hídrico de la C.H. San Gabán II en época de estiaje, se reduce en un volumen de 22 hm³, optado bajo los criterios de confiabilidad en volumen y tiempo, proyectando en ambos casos valores cercanos a 100% para evitar fallas en el abastecimiento del caudal de diseño.

- ENRÍQUEZ (2016). En su investigación: “Estado Hidrológico, Hidráulico y Sedimentológico de los Embalses de la Región Piura”. Nos dice que el objetivo de los embalses es el mejorar la disponibilidad del recurso hídrico, almacenando y regulando las aguas de un río. El proyecto tiene varias partes de la ingeniería involucrada en su diseño y construcción, como por ejemplo la hidráulica, hidrología y sedimentología. La razón de este estudio es la de obtener información acerca de estas disciplinas a fin de mejorar los embalses en la región Piura. Así lograremos comprender el comportamiento de este tipo de proyectos, con el objetivo de encontrar el diseño de embalse más óptimo, para esta zona del país. Esta investigación nos permitirá lograr tener una mejor perspectiva de cara a la situación de estos reservorios. En el embalse Poechos se ha presentado un problema de sedimentación acelerada, puesto que al diseñar este proyecto no se tomó en cuenta la construcción de suficiente cantidad de compuertas para así realizar la evacuación de los sedimentos. En los fenómenos del Niño de los años 1983 y 1998 este problema se incrementó, debido al crecimiento de casi 10 veces la cantidad de carga promedio anual de sedimentos. Haciendo contraste al reservorio San Lorenzo el cuál sigue en funcionamiento, aun habiendo sobrepasado el rango de su vida útil.
- ANTONIO PALAU YBARS (2004). En su investigación: “La sedimentación en embalses”. Los embalses son infraestructuras que suponen una clara discontinuidad en el gradiente longitudinal de procesos propios de los ríos. Junto con el agua, los embalses regulan también los aportes de materiales en suspensión y los arrastres de sólidos transportados por los ríos. El balance de esta regulación tiene como resultado una retención neta de todos estos materiales en forma de sedimentos, dando lugar a la colmatación. En la

actualidad la colmatación de embalses es un problema ambiental de primer orden, en particular en países como España dónde la erosión potencial y real afecta con intensidad a un buen número de ríos regulados. Ciertamente las consecuencias ambientales de colmatación de embalses van más allá de la regresión de deltas o las pérdidas de volumen embalsable y afectan o pueden afectar al funcionamiento general de los embalses como ecosistemas acuáticos. No hay soluciones definidas ni para nuevos embalses ni para embalses en funcionamiento, pero existen medidas tanto preventivas como correctoras que pueden contribuir a minimizar los procesos de colmatación de embalses y/o a reducir los efectos ambientales derivados. Endesa está llevando a cabo vaciados de embalses por motivos de gestión y adecuación de grandes presas, (en las que el grado de colmatación es variable) viendo en cualquier caso la importancia de abordar medidas al respecto. La colmatación junto con la eutrofización, son sin duda las dos principales afecciones ambientales de los embalses a escala mundial y muy en especial en regiones como la Península Ibérica dónde, por un lado, la erosionabilidad de suelos es alta y la irregularidad de escorrentía natural muy notable. Los sedimentos procedentes de las cuencas de drenaje son retenidos en su gran mayoría en los vasos de los embalses dando lugar a una serie de efectos bien conocidos, desde la pérdida de su capacidad de almacenamiento de agua hasta la regresión de deltas, pasando por un buen número de consecuencias y limnologías quizás no tan evidentes, pero no por ello menos importantes, como es la alternación de la pendiente longitudinal del cauce, la formación de humedales, la limitación del uso recreativos de los embalses o la propensión de la eutrofia. Pero, además, la colmatación de un embalse supone una clara pérdida de eficiencia por sí mismo con el correspondiente coste que afecta tanto a rentabilidad

de la inversión inicial de la propia obra hidráulica como a las cuentas de explotación.

- FARÍAS, BREA, GARCÍA (2011). En su investigación: “Proceso de erosión y sedimentación, obras de control y gestión de ríos”. La vida útil real de un embalse puede diferir en mucho de la que se da como estimada y depende del criterio que se aplique para definirla.

La erosión del suelo tiene como efectos principales la pérdida de apoyo necesarios para el crecimiento de las plantas y el transporte de los sedimentos en ríos y embalses, lo que conduce a una pérdida de capacidad de embalse y disminución de la vida útil de los mismos.

Uno de los principales problemas de las presas y embalses es la sedimentación. Los sedimentos son recogidos por el flujo de agua en su recorrido por la cuenca y se acumulan en el fondo. Es preciso tener presente que la mayor parte de los sedimentos arrastrados y que se depositan en los embalses, representan tierras erosionadas de la cuenca, es decir, tierra que se pierde por fenómenos de erosión. De allí entonces, que la mejor manera de evitar la colmatación prematura de un embalse es realizar una práctica adecuada de suelos en la cuenca y el control de los procesos de deforestación.

Para estimar la vida útil es usual considerar que todo el sedimento que genera la cuenca es retenido en el embalse, “eficiencia de atrape” de 100%, lo cuál puede no ser efectivo. Es fácil comprender que en un embalse relativamente pequeño (100 hm³ de capacidad), por ejemplo el volumen de una creciente puede ser varias veces superior a la capacidad del embalse; en este caso, una parte de la descarga sólida pasará directamente por el vertedero.

2.2. Marco Teórico

2.2.1. Modelo Digital de Elevación (DEM)

2.2.1.1. Levantamiento Topográfico

Se define como tal el conjunto de operaciones ejecutadas sobre un terreno con los instrumentos adecuados para poder confeccionar una correcta representación gráfica o plano. Este plano resulta esencial para situar correctamente cualquier obra que se desee llevar a cabo, así como para elaborar cualquier proyecto técnico. Si se desea conocer la posición de puntos en el área de interés, es necesario determinar su ubicación mediante tres coordenadas que son latitud, longitud y elevación o cota. (FRANQUET BERNIS & QUEROL GÓMEZ , 2010)

2.2.1.1.1. Herramientas

Las herramientas más comunes para realizar un levantamiento topográfico son la estación total y el GPS, aunque en los últimos años se han incorporado sofisticados drones para realizar esta actividad.

A. Estación Total

La estación total viene de la fusión de un distanciómetro, un teodolito electrónico y un microprocesador, cuya función principal es la de agilizar las mediciones que antes se realizaban con un teodolito convencional, pero ahora incorpora aplicaciones y programas que nos dan una mayor precisión y exactitud de las medidas, haciendo que el manejo o la aparición de errores acumulativos se disminuyan considerablemente. (Alcántara Portal, 2015)

B. Drone

Los vehículos aéreos no tripulados, también conocidos como drones, son controlados por pilotos en tierra o de forma autónoma siguiendo una misión pre programada, y no sólo consta del equipo visible en vuelo, requiere un control, una base en tierra, y de un piloto que cumpla un protocolo de vuelo. Pueden ser equipados con cámaras, que proporcionan imágenes aéreas y videos de distintos eventos. (Pinto D., 2016)

2.2.1.1.2. Etapas

A. Planificación

La realización de cualquier levantamiento topográfico exige una planificación previa de la metodología de trabajo a realizar, con el objetivo de optimizar recursos y obtener los mejores resultados para conseguir los objetivos expuestos. Una mala planificación del trabajo puede llevar a diferentes problemas que pueden aumentar el coste y el tiempo de realización de las labores topográficas y en el peor de los casos, a la repetición de parte del mismo, así pues este es un apartado fundamental. (Grosche, 2010)

B. Señalización

Una vez que se ha establecido el plan de trabajo se hace necesario pasar a la fase de señalización; esta actividad constituye un paso importante en todo levantamiento topográfico, ya que la misma resalta la ubicación de los puntos de control y de cualquier otro punto de interés, de acuerdo al propósito y permanencia en el sitio. (Swanston, 2006)

Las señales pueden ser:

- Señales de puntería: Se refiere a cuándo se dirigen visuales desde otros puntos, en este tipo pueden señalarse al jalón y las miras. (Pachas L., 2009)
- Señales de observación: Se refiere a los puntos de control, generalmente se encuentran al ras del piso y debido a su importancia son resguardadas y referenciadas por el responsable en campo. (Pachas L., 2009)
- Señales de doble propósito: Se refiere a puntos que son de control y al mismo tiempo van a ser observados desde otros puntos del terreno. (Pachas L., 2009)
- Señales permanentes: Se construyen para que sean visibles durante la fase de levantamientos y las otras etapas del proyecto y que además permanezcan aún una vez finalizado el mismo para ser utilizadas en el control de la obra que se va a construir. (Pachas L., 2009)
- Señales semipermanentes: Se espera que duren desde la fase de estudio hasta la finalización de la construcción, generalmente son construidas con concreto pobre. (Pachas L., 2009)
- Señales transitorias: Son señales que sirven solamente para materializar las verticales tanto de los puntos de control como de detalle (Pachas L., 2009)

C. Ejecución del Vuelo con Drone

Una vez se ha realizado el plan de vuelo y se han ubicado los puntos de control se procede a cargar la lista de waypoints en la memoria interna del autopiloto del drone para luego ejecutar la misión de vuelo de forma automática. (Santana Cruz, 2017)

D. Captura de Datos

Al realizar un levantamiento con GPS y Estación Total, se entiende por captura de datos a la acción de registrar y almacenar las magnitudes requeridas y almacenar las magnitudes requeridas para el cálculo de las coordenadas de los puntos levantados. (Pachas L., 2009)

Para la captura de datos mediante el dron se colocan referencias o señales en toda la superficie a fotografiar para la obtención de los puntos de apoyo con coordenadas G.P.S. Estos puntos servirán para transformar el modelo fotogramétrico en modelo del terreno. (Ferreira, 2017)

2.2.1.2. Procesamientos de Datos y Generación del DEM

2.2.1.2.1. Softwares

A. Agisoft Photoscan

Es un producto de software independiente que realiza el procesamiento fotogramétrico de imágenes digitales y genera datos espaciales en 3D para su uso en aplicaciones SIG. (Agisoft, 2019)

B. AutoCAD Civil 3D

- Las funciones de topografía de AutoCAD Civil 3D se pueden utilizar para descargar, crear, analizar y ajustar datos de levantamiento. (Autodesk, 2018)
- Las herramientas de análisis, como los mínimos cuadrados, permiten realizar ajustes en las redes de topografía y en poligonales individuales. (Autodesk, 2018)

2.2.1.2.2. Etapas

A. Importación de imágenes

Desde el software Agisoft Photoscan se realiza la importación de las imágenes que hemos obtenido con el dron, para lo cual no debemos dirigir a “Flujo de Trabajo”, luego dar clic en “Añadir Fotos” y seleccionar todas las imágenes de nuestro proyecto, y para finalizar procedemos a dar clic en “Abrir”.

B. Orientación de imágenes

Para realizar la orientación de imágenes debemos dirigirnos a “Flujo de Trabajo”, luego dar clic en “Orientar Fotos”, posteriormente debemos elegir una Precisión, que puede ser: Mínima, Baja, Media, Alta, Máxima; siendo esta última la más recomendada ya que se tomarían más puntos en común. También podemos elegir un tipo de emparejamiento que puede ser de manera predeterminada o Genérico; por Referencia, si se tuviera un sistema de referencia; debemos activar la casilla “Adaptativo ajuste del modelo de cámara” y dar clic en aceptar para iniciar el proceso.

C. Orientación absoluta

Para obtener una orientación absoluta pueden realizarse mediante puntos de control de los que se conocen las coordenadas “X”, “Y”, “Z” y de modo que por medio de una buena distribución de los puntos tendremos el Sistema de Referencia deseado.

D. Creación de Nube de Puntos Densa

Para la creación debemos dirigirnos a “Flujo de Trabajo”, luego dar clic en “Crear Nube de Puntos

Densa”, posteriormente debemos elegir la calidad, la cuál de preferencia debe ser “Alto o Ultra Alto” y dar clic en “Aceptar”.

E. Creación de Malla

Para la creación debemos dirigirnos a “Flujo de Trabajo”, luego dar clic en “Crear Malla”, posteriormente dar clic en “Aceptar” dejando las opciones seleccionadas por defecto.

F. Creación de Textura

Para la creación debemos dirigirnos a “Flujo de Trabajo”, luego dar clic en “Crear Textura”, posteriormente activamos la casilla de “Activar Corrección de Color” y dar clic en “Aceptar”.

G. Creación de Ortomosaico

Para la creación debemos dirigirnos a “Flujo de Trabajo”, luego dar clic en “Crear Ortomosaico”, posteriormente seleccionamos el tipo de Superficie, en este caso “Modelo Digital de Elevaciones”, en el Modo de Mezcla seleccionamos “Mosaico (Por Defecto)”, en Tamaño de Pixel editamos el número y lo dejamos con 2 cifras decimales y damos clic en “Aceptar”.

2.2.2. Estudio Hidrológico

2.2.2.1. Curva de Caudales Clasificados

La curva puede representar los 365 caudales de un año hidrológico concreto, o haber sido elaborada con datos diarios de una larga serie de años. Su utilidad es inmediata, si se está proyectando una obra que necesita un caudal mínimo, la curva indica cuántos días al año no se alcanzará ese caudal necesario. (Sánchez San Román, 2013)

2.2.2.2. Avenidas y aguas altas

Avenida también conocida como Crecida, es la elevación del nivel de un curso de agua significativamente mayor que el flujo medio de este. (Avenida, s.f.)

Aguas Altas es el máximo nivel del agua alcanzado durante una avenida o durante la explotación del embalse. (Aguas Altas, s.f.)

2.2.2.3. Caudal Dominante o Formativo de cauce (Bankfull Discharge)

La formación del cauce de un río es el resultado del cambio constante de las descargas, y la descarga a cauce lleno, es usualmente utilizada como la descarga formativa del cauce, para cambios en la geometría del canal, aguas abajo. (Apaclla, 2014)

Esta simplificación aproximada se justifica en el lecho de que descargas bajas, con movimiento mínimo de sedimentos, contribuyen menos en cuanto a la formación del cauce. También, el incremento en la descarga por encima del nivel de los bancos llenos es, mayormente, absorbido por el ancho de la planicie de inundación y por

lo tanto generalmente tiene menos efecto en la forma del canal. (Apacla, 2014)

Existen varios criterios en su definición, dos de los cuales se mencionan a continuación: Como aquel caudal que, de permanecer constante a lo largo del año, transporta la misma cantidad de material de fondo que el hidrograma anual. Como el caudal máximo que es capaz de pasar por el cauce principal sin que desborde hacia la planicie. Este criterio ha conducido a resultados más congruentes. (Apacla, 2014)

La descarga formativa o dominante de varios ríos estudiados por Williams (1978) no tiene una frecuencia recurrente común. Usando un conjunto de 233 datos, Williams obtuvo la siguiente ecuación de regresión para la descarga formativa. (Apacla, 2014)

$$Q = 4.0 A_f^{1.21} S^{0.28}$$

Donde:

Q = Descarga dominante en pies³/s.

A_f = Área correspondiente al cauce con caudal dominante.

S = Pendiente de la superficie de agua.

La descarga dominante usualmente es mayor que la descarga media anual. Chang (1979), basado en datos publicados por Schumm (1968) y Carlston (1965), obtuvo una relación entre la descarga dominante y la descarga media, como se muestra en la figura. (Apacla, 2014)



Ilustración 1 - Relación entre descarga dominante y descarga media (Chang 1979). Fuente: Apacla, 2014

2.2.2.4. Análisis Estadísticos de Datos Hidrológicos

2.2.2.4.1. Análisis de Consistencia

Es el proceso que consiste en la identificación o detección, descripción y remoción de la no homogeneidad e inconsistencia de una serie de tiempo hidrológica. (Villón Béjar, 2016)

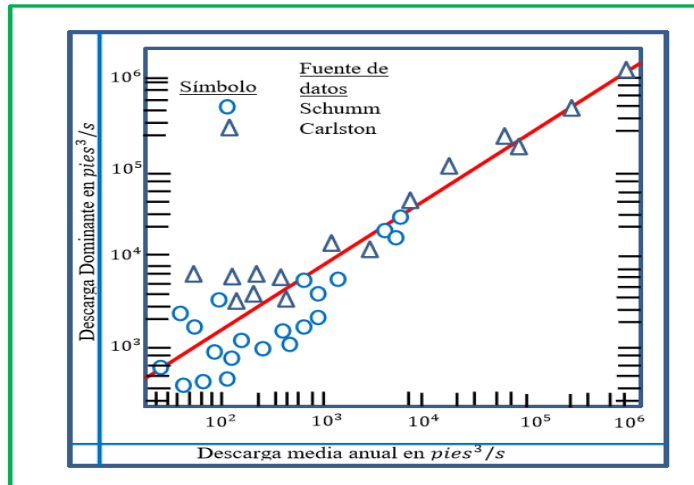
Antes de utilizar la serie histórica para el modelamiento, es necesario efectuar el análisis de consistencia respectivo, a fin de obtener una serie confiable, es decir, homogénea y consistente. (Villón Béjar, 2016)

A. Análisis visual gráfico

En coordenadas cartesianas se plotea la información hidrológica histórica, ubicándose en las ordenadas, los valores de la serie y en las abscisas el tiempo (años, meses, días, etc.). (Villón Béjar, 2016)

B. Análisis doble masa

Este análisis se utiliza para tener una cierta confiabilidad en la información, así como también,

para analizar la consistencia en lo relacionado a errores, que pueden producirse durante la obtención de los mismos, y no para una corrección a partir de la recta de doble masa. (Villón Béjar, 2016)

C. Análisis Estadístico

Después de obtener de los gráficos construidos para el análisis visual y de los de doble masa, los periodos de posible corrección, y los periodos de datos que se mantendrán con sus valores originales, y se procede a los análisis estadísticos de saltos, tanto en la media como en la desviación estándar. (Villón Béjar, 2016)

2.2.2.4.2. Parámetros Estadísticos

A. Media

Es la medida de tendencia central que se utiliza con mayor frecuencia. Se calcula tomando todos los datos de un conjunto de datos y dividiéndolo entre el total de elementos involucrados. (Estuardo Morales, 2012)

$$\bar{X} = \sum_{i=1}^n \frac{x_i}{n}$$

Donde:

n = Número de datos.

Xi = Valor i de la muestra.

\bar{X} = Media

B. Varianza

Se define como el promedio aritmético de las diferencias entre cada uno de los valores del conjunto de datos y la media aritmética del conjunto elevadas al cuadrado. (Estuardo Morales, 2012)

$$S^2 = \frac{\sum_{i=1}^n (x_i - \bar{x})^2}{n - 1}$$

Dónde:

\bar{X} = Media.

S^2 = Varianza.

x_i = Valor i de la muestra.

C. Desviación Estándar

Es la raíz cuadrada positiva de una Varianza.

(Estuardo Morales, 2012)

$$S = \sqrt{\frac{\sum_{i=1}^n (x_i - \bar{x})^2}{n - 1}}$$

D. Coeficiente de Variación

Es una medida que relaciona la desviación estándar y la media. (Estuardo Morales, 2012)

$$Cv = \frac{S}{\bar{X}}$$

Dónde:

Cv = Coeficiente de Variación.

\bar{X} = Media.

S = Desviación Estándar.

E. Coeficiente de Asimetría

(Estuardo Morales, 2012)

$$Cs = \frac{n \sum_{i=1}^n (x_i - \bar{x})^3}{(n - 1)(n - 2)(S^3)}$$

Dónde:

n = Número de datos.

S = Desviación Estándar.

X_i = Valor i de la muestra.

\bar{X} = Media.

2.2.2.4.3. Periodo de Retorno

Es el intervalo promedio de tiempo en años, en el cual un determinado evento de una magnitud “x” puede ser igualado o excedido, por lo menos una vez en promedio; podemos decir que, si un evento mayor o igual a “x”, ocurre una vez en T años, por lo tanto, la probabilidad de que este evento ocurra (P) es igual a 1 en T casos. (Villón Béjar, 2016)

$$P(X \geq x) = \frac{1}{T}$$

Ordenando la ecuación tendríamos:

$$T = \frac{1}{P(X \geq x)}$$

Donde:

$P(X \geq x)$ = Probabilidad de que ocurra un evento con magnitud igual o mayor que “x”.

T = Periodo de Retorno.

Según lo mencionado anteriormente podemos deducir que la probabilidad de que “x” no ocurra en cualquier año; es decir, la probabilidad de que ocurra un evento menor a “x”, se expresa como:

$$P(X < x) = 1 - P(X \geq x)$$

Entonces:

$$P(X < x) = 1 - \frac{1}{T}$$

Ordenando la ecuación tendríamos:

$$T = \frac{1}{1 - P(X < x)}$$

Donde:

T =Periodo de Retorno.

$P(X \geq x)$ =Probabilidad de excedencia.

$P(X < x)$ =Probabilidad de no excedencia.

2.2.2.4.4. Intervalo de Confianza

Es un rango de valores (calculado en una muestra) en el cual se encuentra el verdadero valor del parámetro, con una probabilidad determinada. La probabilidad que el verdadero valor del parámetro se encuentre en el intervalo construido se denomina nivel de confianza y se denota con $1 - \alpha$. La probabilidad de equivocarse se llama nivel de significancia y se simboliza con α .

Generalmente se construyen intervalos con confianza $1 - \alpha = 95\%$ (o significancia $\alpha = 5\%$). Menos frecuentes son los intervalos con $\alpha = 10\%$ o $\alpha = 1\%$. (Botella, Alacreu, & Martínez)

2.2.2.4.5. Modelo de Distribución

El análisis de frecuencias tiene la finalidad de estimar precipitaciones, intensidades o caudales máximos, según sea el caso, para diferentes periodos de retorno, mediante la aplicación de modelos probabilísticos, los cuales pueden ser discretos o continuos. (MTC, 2015)

En la estadística existen diversas funciones de distribución de probabilidad teóricas; recomendándose utilizar las siguientes funciones:

a) Distribución Normal

La función de densidad de probabilidad normal se define como.

$$f(x) = \frac{1}{S\sqrt{(2\pi)}} e^{-\frac{1}{2}\left(\frac{x-\mu}{S}\right)^2}$$

Donde:

$f(x)$ = Función densidad normal de la variable x .

X = Variable independiente.

μ = Parámetro de localización, igual a la media aritmética de X .

S = Parámetro de escala, igual a la desviación estándar de X .

b) Distribución Log Normal 2 parámetros

La función de distribución de probabilidad es:

$$P(x \leq x_i) = \frac{1}{S\sqrt{(2\pi)}} \int_{-\infty}^{x_i} e^{-\frac{(x-\bar{X})^2}{2S^2}}$$

Dónde \bar{X} y S son los parámetros de la distribución.

Si la variable x de la ecuación se reemplaza por una función $y=f(x)$, tal que $y=\log(x)$, la función puede normalizarse, transformándose en una ley de probabilidades denominada log – normal, $N(Y, S_y)$. Los valores originales de la variable aleatoria X , debe ser transformados a $y=\log x$, de tal manera que:

$$\bar{Y} = \sum_{i=1}^n \log x_i / n$$

Donde \bar{Y} es la media de los datos de la muestra transformada.

$$S_y = \sqrt{\frac{\sum_{i=1}^n (y_i - \bar{Y})^2}{n - 1}}$$

Dónde S_y es la desviación estándar de los datos de la muestra transformada.

Asimismo; se tiene las siguientes relaciones:

$$C_s = a/S^3y$$

$$a = \frac{n}{(n-1)(n-2)} \sum_{i=1}^n (y_i - \bar{Y})^3$$

Donde C_s es el coeficiente de oblicuidad de los datos de la muestra transformada.

c) Distribución Log Normal 3 parámetros

La función de densidad de x es:

$$f(x) = \frac{1}{(x - x_0)\sqrt{(2\pi)S_y}} e^{-1/2\left(\frac{\ln(x-x_0)-u_y}{S_y}\right)^2}$$

Para $x > x_0$

Dónde:

X_0 = Parámetro de posición.

U_y = Parámetro de escala o media.

S_y^2 = Parámetro de forma o varianza.

d) Distribución Gamma 2 parámetros

La función de densidad es:

$$f(x) = \frac{x^{\gamma-1} e^{-\frac{x}{\beta}}}{\beta^{\gamma} \Gamma(\gamma)}$$

Válido para:

$$0 \leq x < \infty$$

$$0 < \gamma < \infty$$

$$0 < \beta < \infty$$

Donde:

γ = Parámetro de forma.

B = Parámetro de escala.

e) Distribución Gamma 3 parámetros

La función de densidad es:

$$f(x) = \frac{(x - x_0)^{\gamma-1} e^{-\frac{(x-x_0)}{\beta}}}{\beta^{\gamma} \Gamma(\gamma)}$$

Válido para:

$$x_0 \leq x < \infty$$

$$-\infty < x_0 < \infty$$

$$0 < \beta < \infty$$

$$0 < \gamma < \infty$$

Dónde:

x_0 = Origen de la variable x, parámetros de posición.

γ = Parámetro de forma.

β = Parámetro de escala.

f) Distribución Log Pearson tipo III

La función de densidad es:

$$f(x) = \frac{(\ln x - x_0)^{\gamma-1} e^{-\frac{(\ln x - x_0)}{\beta}}}{x \beta^{\gamma} \Gamma(\gamma)}$$

Válido para:

$$x_0 \leq x < \infty$$

$$-\infty < x_0 < \infty$$

$$0 < \beta < \infty$$

$$0 < \gamma < \infty$$

Dónde:

x_0 = Parámetro de posición.

γ = Parámetro de forma.

β = Parámetro de escala.

g) Distribución Gumbel

La distribución de Valores Tipo I conocida como Distribución Gumbel o Doble Exponencial, tiene como función de distribución de probabilidades la siguiente expresión:

$$F(x) = e^{-e^{-\alpha(x-\beta)}}$$

Utilizando el método de momentos, se obtienen las siguientes relaciones:

$$\alpha = \frac{1.2825}{\sigma}$$

$$\beta = \mu - 0.45\sigma$$

Donde:

α = Parámetro de concentración.

B = Parámetro de localización.

Según Ven Te Chow, la distribución puede expresarse de la siguiente forma:

$$x = \bar{x} + k\sigma_x$$

Dónde:

x = Valor con una probabilidad dada.

\bar{x} = Media de serie.

k = Factor de frecuencia.

h) Distribución Log Gumbel

La variable aleatoria reducida log Gumbel, se define como:

$$y = \frac{\ln x - \mu}{\alpha}$$

Con lo cual, la función acumulada reducida log Gumbel es:

$$G(y) = e^{-e^{-y}}$$

2.2.2.4.6. Prueba de Bondad de Ajuste

Las pruebas de bondad de ajuste son pruebas de hipótesis que se usan para evaluar si un conjunto de datos es una muestra independiente de la distribución elegida. (MTC, 2015)

En la teoría estadística, las pruebas de bondad de ajuste más conocidas son la X^2 y la Kolmogorov – Smirnov, las cuales se describen a continuación. (MTC, 2015)

A) X^2

Esta prueba fue propuesta por Karl Pearson en 1900, se aplica para verificar bondad de las distribuciones normales y log normales.

Para aplicar la prueba, el primer paso es dividir los datos en un número k de intervalos de clase. Luego se calcula el parámetro estadístico: (MTC, 2015)

$$D = \sum_{i=1}^k (\theta_i - \varepsilon_i)^2 / \varepsilon_i$$

Donde:

θ_i = Es el número observado de eventos en el intervalo i y ε_i es el número esperado de eventos en el mismo intervalo.

ε_i = se calcula como:

$$\varepsilon_i = n[F(S_i) - F(I_i)] \quad i = 1, 2, \dots, k$$

Asimismo; $F(S_i)$ es la función de distribución de probabilidad en el límite superior del intervalo i , $F(I_i)$ es la misma función en el límite inferior y n es el número de eventos. (MTC, 2015)

Una vez calculado el parámetro “D” para cada función de distribución considerada, se determina el valor de una variable aleatoria con distribución X^2 para $v=k-1-m$ grados de libertad y un nivel de significancia α , donde m es el número de parámetros estimados a partir de los datos. (MTC, 2015)

Para aceptar una función de distribución dada, se debe cumplir:

$$D \leq X^2_{1-\alpha, k-1-m}$$

El valor de $X^2_{1-\alpha, k-1-m}$ se obtiene de tablas de la función de distribución X^2 .

Cabe recalcar que la prueba del X^2 , desde un punto de vista matemático solo debería usarse para comprobar la normalidad de las funciones normal y Log normal. (MTC, 2015)

B) Prueba Kolmogorov – Smirnov

Método por el cual se comprueba la bondad de ajuste de las distribuciones, asimismo permite elegir la más representativa, es decir la de mejor ajuste.

Esta prueba consiste en comparar el máximo valor absoluto de la diferencia D entre la función de distribución de probabilidad observada $F_o(x_m)$ y la estimada $F(x_m)$:

$$D = \text{máx } |F_o(x_m) - F(x_m)|$$

Con un valor crítico d que depende del número de datos y el nivel de significancia seleccionado. Si $D < d$, se acepta la hipótesis nula. Esta prueba tiene la ventaja sobre la prueba de X^2 que compara los datos con el modelo estadístico sin necesidad de agruparlos. La función de distribución de probabilidad observada se calcula como:

$$F_o(x_m) = 1 - m/(n + 1)$$

Donde m es el número de orden de dato x_m en una lista de mayor a menor y n es el número total de datos.

2.2.3. Hidráulica Fluvial

2.2.3.1. Morfología de un río

2.2.3.1.1. Perfil Longitudinal

El perfil longitudinal de un río muestra cómo éste va perdiendo cota a lo largo de su recorrido, en él se puede observar la pendiente de cada tramo. Los perfiles longitudinales de los ríos suelen presentar forma cóncava, su pendiente disminuye desde las zonas más erosivas (zonas de cabecera) a las zonas donde predomina la sedimentación (zona de desembocadura o bajas). Se establece una función del tipo((Pérez, Rodríguez, & Molina, 2018):

$$S_x = S_0 e^{-ax}$$

Donde:

S_x es la pendiente a la distancia x , aguas debajo de la sección de referencia.

S_0 es la pendiente original.

a es el coeficiente de disminución de la pendiente.

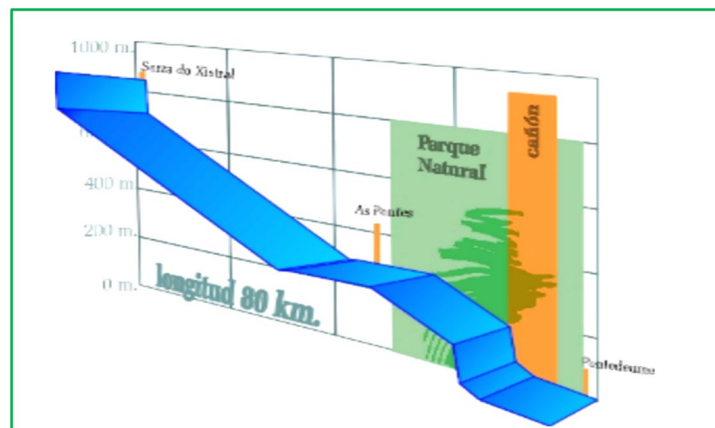

*Ilustración 2 - Ejemplo de Perfil Longitudinal de un Río.
(Pérez, Rodríguez, & Molina, 2018)*

Desde las zonas de cabecera hasta las de desembocadura el sistema fluvial va cambiando,

adquiere mayor tamaño. La influencia terrestre de las orillas se debilita debido al aumento de caudal y carga de sedimentos provenientes de las zonas altas. (Pérez, Rodríguez, & Molina, 2018)

2.2.3.1.2. Estado de Equilibrio

Se dice que un tramo fluvial se encuentra en estado de equilibrio cuando la cantidad de sólidos que ingresa es igual a la que sale, en un tiempo determinado. En dicho tramo no hay erosión ni sedimentación. (Rocha, 1998)



Ilustración 3 - Estado de Equilibrio. En el tramo 1-2 no hay erosión ni sedimentación ($TF1 = TF2$) (Vide, 2002)

2.2.3.1.3. Llanuras de Inundación

Las llanuras de inundación son las áreas próximas al cauce principal del río que resultan ocasionalmente inundadas. La llanura de inundación es un terreno muy llano, pero con distintas formaciones. (Vide, 2002)

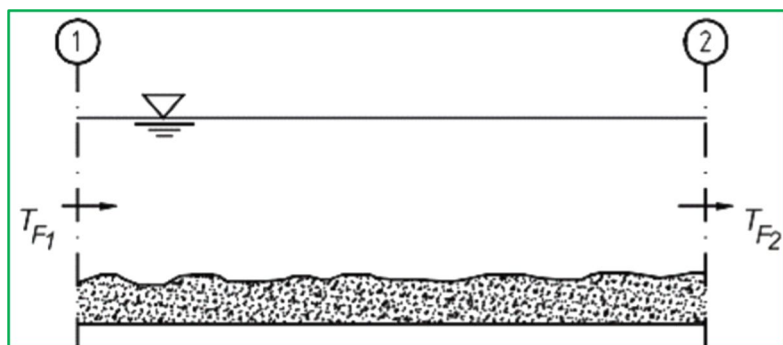

Ilustración 4 - Llanuras de inundación. (Vide, 2002)

2.2.3.2. Clasificación de los ríos

2.2.3.2.1. Por su edad

El comportamiento de los ríos se puede asemejar al del ser humano y conforme a ello por su edad se les clasifica en:

A) Ríos Jóvenes

Es aquel que se encuentra en las montañas, que tiene pendientes fuertes y sección transversal en forma de "V", son muy irregulares y su flujo es impetuoso, por lo que se encuentran generalmente en proceso de socavación. (Pérez, Rodríguez, & Molina, 2018)

B) Ríos Maduros

Se presenta en valles amplios y tiene pendiente relativamente baja, la erosión de los márgenes ha reemplazado a la erosión del fondo, tienden a ser estables ya que su sección transversal, en cada tramo, es capaz de transportar la carga de sedimentos en todo su recorrido, su flujo es moderadamente rápido. (Pérez, Rodríguez, & Molina, 2018)

C) Ríos Viejos

Se encuentran en valles amplios y planicies cuyo ancho es de 15 a 20 veces mayor que el ancho de los meandros, carecen de rápidas y caídas, con pendientes muy bajas, que dan origen a la frecuente formación de pantanos en las zonas vecinas a los márgenes del río, con forma de cuerno o herradura, que son restos de meandros abandonados y que cortaron en forma natural. (Pérez, Rodríguez, & Molina, 2018)

2.2.3.2.2. Por su Morfología

Se refiere al tipo de trayectoria que presenta en planta. La sinuosidad, que se estima como el cociente entre la longitud del río y la longitud del valle en un tramo, permite diferenciar los siguientes tipos:

A) Ríos Rectos

Normalmente se presenta en pequeños tramos y son transitorios, ya que con cualquier irregularidad se propicia la formación de meandros. Un criterio para identificarlos es el cociente de sinuosidad que no debe ser mayor a 1.2, no se aprecian líneas en el cauce pero la línea de thalweg (voz procedente del alemán que significa “camino del valle”), se desplaza alternativamente de una orilla a la otra, haciéndose más visible en aguas bajas. (Pérez, Rodríguez, & Molina, 2018)



Ilustración 5 - Río Recto. (Pérez, Rodríguez, & Molina, 2018)

$$P = \frac{\text{Long. Thalweg}}{\text{Long. Valle}}$$

Dónde:

Long. Thalweg es la longitud de la línea que se encuentra en medio de la parte más profunda del río y donde la corriente es más rápida.

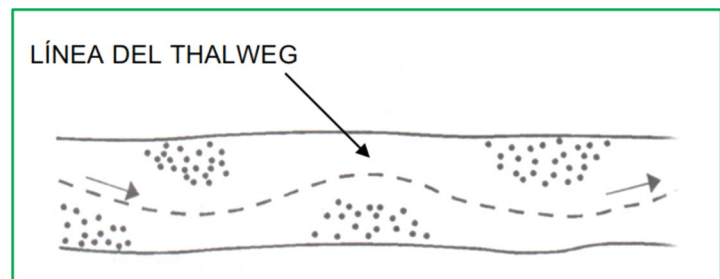
Long.Valle es la longitud en línea recta del valle donde se encuentra el río, desde el punto inicial al final del tramo en estudio.

B) Ríos Entrelazados

Son los que se desarrollan en tramos de mayor pendiente o cuando la carga sólida es elevada, y se caracterizan por la formación de un curso de agua ancho y poco profundo, que se divide en varios brazos dejando cauces secundarios, uniéndose hacia aguas abajo y volviéndose a separar, a modo de trenzas. La principal característica de estos ríos es que se encuentran en un proceso natural de sedimentación. (Pérez, Rodríguez, & Molina, 2018)



Ilustración 6 - Ríos Entrelazados (Pérez, Rodríguez, & Molina, 2018)

C) Ríos Meándricos

Es cuándo el coeficiente de sinuosidad es superior a 1.5, debido a las curvas que desarrolla el cauce desplazándose en sentido transversal del valle hacia un lado y otro. El tipo de curvas o meandros puede ser muy diferente de unos ríos a otros, pudiéndose diferenciar entre ellos una subclasificación que es:

-Con curvas superficiales.

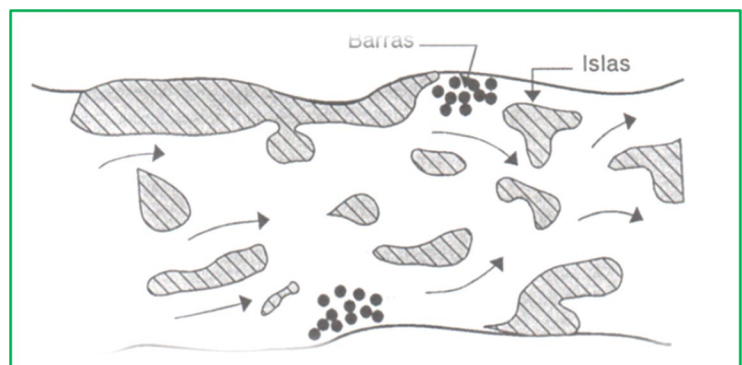
-Con curvas en trinchera

Siendo su principal diferencia que los de curva superficial cambian su curso en el tiempo y los de curvas en trinchera no, ya que generalmente se encuentran formados en material resistente. (Pérez, Rodríguez, & Molina, 2018)



Ilustración 7 - Ríos Meándricos. (Pérez, Rodríguez, & Molina, 2018)

2.2.3.2.3. Por su Pendiente

A) Ríos Torrenciales

Son los que tienen una pendiente mayor a 1.5%.
(Vide, 2002)

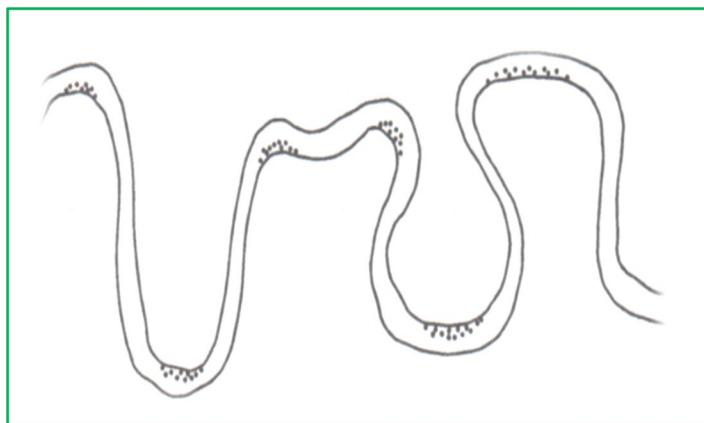
B) Ríos Torrentes

Son los que tienen una pendiente mayor a 6%.
(Vide, 2002)

2.2.3.3. Inundación

Una inundación es el desborde lateral de las aguas de los ríos, lagos y mares que cubre temporalmente los terrenos bajos adyacentes. Suele ocurrir en épocas de lluvias intensas, marejadas y en caso de tsunamis. (INDECI, 2011)

2.2.3.3.1. Tipos

A) Inundación Estática

Generalmente se producen cuando las lluvias son persistentes y generalizadas, producen un aumento paulatino del caudal y del río hasta superar su capacidad máxima de transporte, por lo que el río se desborda, inundando áreas planas cercanas al mismo, a estas áreas se les denomina llanuras de inundación. (INDECI, 2011)

B) Inundación Dinámica

Se producen en ríos cuyas cuencas presentan fuertes pendientes, por efecto de las lluvias intensas. Las crecidas de los ríos son repentinas y de corta duración. (INDECI, 2011)

2.2.3.4. Tipos de Flujos

Los flujos se dividen según el criterio que se utilice para hacer su análisis.

2.2.3.4.1. Criterio de Tiempo

Bajo este criterio los flujos se clasifican en:

A) Flujo Permanente

Es cuándo las propiedades del fluido y las condiciones del movimiento en cualquier punto no cambian con el tiempo. (Niño & Duarte, 2004)
Analíticamente esta condición física queda expresada, para la velocidad, por la ecuación (Niño & Duarte, 2004):

$$\frac{d\vec{U}}{dt} = 0$$

Siendo x, y, z constantes. De igual manera en este tipo de flujos no existen cambios en la

densidad ρ , presión P , temperatura T° , por lo que (Niño & Duarte, 2004):

$$\frac{d\rho}{dt} = 0 \rightarrow \frac{dP}{dt} = 0 \rightarrow \frac{dT}{dt} = 0$$

B) Flujo No Permanente

Es cuándo las condiciones del flujo en cualquier punto cambian con el tiempo, es decir que para la velocidad la ecuación es (Niño & Duarte, 2004):

$$\frac{d\vec{U}}{dt} \neq 0$$

2.2.3.4.2. Criterio de Espacio

A) Flujo Uniforme

Es cuándo en cualquier punto del fluido, el vector velocidad es idéntico, es decir con igual módulo, dirección y sentido en un instante dado; por lo tanto (Niño & Duarte, 2004):

$$\frac{d\vec{U}}{ds} = 0$$

Siendo el diferencial s un desplazamiento cualquier.

B) Flujo Variado

Es cuándo el vector velocidad varía en un instante dado de un punto a otro por lo que (Niño & Duarte, 2004):

$$\frac{d\vec{U}}{ds} \neq 0$$

2.2.3.4.3. Criterio de Viscosidad

A) Flujo Laminar

Se puede describir como un movimiento ordenado de las partículas de fluido cuyo conjunto forman capas láminas. (Niño & Duarte, 2004)

B) Flujo Turbulento

Se describe por un movimiento desordenado, caótico y al azar de las partículas de fluido. (Niño & Duarte, 2004)

C) Flujo Transicional

Se describe como la mezcla de un flujo laminar y un flujo turbulento. (Niño & Duarte, 2004)

2.2.3.4.4. Criterio de N° Froude (Fr)

$$Fr = \frac{V}{\sqrt{gD}}$$

$$D(\text{Profundidad Hidráulica}) = \frac{\text{Área Mojada}}{\text{Ancho Superficial}}$$

A) Flujo Subcrítico

El valor de $Fr < 1$.

B) Flujo Crítico

El valor de $Fr = 1$.

C) Flujo Supercrítico

El valor de $Fr > 1$.

2.2.3.4.5. Criterio de Velocidad

A) Flujo Unidimensional

Es un flujo en el que el vector velocidad depende de sólo una variable espacial. (Poterr, 2015)

B) Flujo Bidimensional

Es un flujo en el que el vector velocidad depende sólo de dos variables espaciales. (Poterr, 2015)

C) Flujo Tridimensional

El vector velocidad depende de tres coordenadas espaciales. (Poterr, 2015)

2.2.4. Software

2.2.4.1. Generación del Modelo Digital de Elevación (DEM)

2.2.4.1.1. AutoCAD Civil 3D 2019

- Las funciones de topografía de AutoCAD civil 3D se pueden utilizar para descargar, crear, analizar y ajustar datos de levantamiento. (Autodesk, 2018)
- Las herramientas de análisis, como los mínimos cuadrados, permiten realizar ajustes en las redes de topografía y en poligonales individuales. (Autodesk, 2018)

2.2.4.1.2. Agisoft Photoscan

Es un software que sirve para procesar imágenes digitales y, mediante la combinación de técnicas de fotogrametría digital y visión por computador, generar una reconstrucción 3D del entorno. (Ferreira, 2017)

2.2.4.1.3. ArcGis 10.2.2

- Genera datos de elevación usando el asistente de DEM. (ESRI, 2016)
- Crea y analiza superficies y otros datos en 3D. (ESRI, 2016)
- Importar datos de entidades 3D de diversas fuentes. (ESRI, 2016)

- Utilizar un TIN como fuentes de elevación. (ESRI, 2016)
- Administrar, mantener y editar datos LIDAR. (ESRI, 2016)

2.2.4.2. Estudio Hidrológico

2.2.4.2.1. Aplicación del HYDROILA.

- Es un software que permite el cálculo de la intensidad de lluvia en cualquier zona del Perú con datos como la zona, la sub zona, el Periodo de Retorno, el tiempo de duración de la tormenta y el intervalo de la duración de la lluvia.
- Podemos exportar los resultados obtenidos a una hoja de Excel mediante un solo botón.
- Podemos exportar el Hietograma obtenido.
- Podemos exportar la Curva IDF.

2.2.4.2.2. HEC- HMS 4.4.1.

- Es un software que permite el cálculo del caudal de entrada obtenido mediante la construcción de componentes, como el modelo de la cuenca, modelo meteorológico, control de especificaciones y por último con los medidores de lluvia según su respectivo intervalo de tiempo.

2.3. Marco Conceptual

- **Waypoints:** Son coordenadas para ubicar puntos de referencia tridimensionales utilizados en la navegación basada en GPS (Global Positioning System: Sistema de Posicionamiento Global).
- **Ortomosaico:** Es una representación proyectada ortogonal del terreno en forma de foto.
- **Planicie:** Es una gran extensión de terreno que no presenta fuertes desniveles.
- **Significancia:** Es un concepto estadístico asociado a la verificación de una hipótesis, en otras palabras, es la probabilidad de tomar la decisión de rechazar la hipótesis nula cuando ésta es verdadera.
- **Erosión:** Es el proceso de desgaste que sufre la roca madre que conforma el suelo como consecuencia de procesos geológicos exógenos como ser las corrientes de agua o hielo glacial, los fuertes vientos, los cambios de temperatura u otros acontecimientos.
- **Desembocadura:** Es el lugar en el que una corriente de agua desemboca en otra, en el mar o en un lago.
- **Llanura:** Terreno extenso que no presenta fuertes desniveles.
- **Socavación:** Es la excavación profunda causada por el agua.

2.4. Hipótesis

2.4.1. General

Mediante la propuesta de diseño para la presa; se logrará encontrar una alternativa de solución que contrarreste la escasez de recurso hídrico en épocas de estiaje.

2.5. Variables

2.5.1. Variable Independiente

- Caudal.
- Topografía.

2.5.2. Variable Dependiente

- Características físicas de la presa.

2.6. Operacionalización de Variables

VARIABLE INDEPENDIENTE	DIMENSIONES	INDICADORES	MEDICIÓN
CAUDAL	VELOCIDAD	VECTORIAL	m ³ /s
	ÁREA	POLIGONAL	Km ²
TOPOGRAFÍA	DISTANCIA	LONGITUD	Km
	COORDENADAS	LONGITUD	Km
		LATITUD	UTM
	ÁREA	POLIGONAL	Km ²

Tabla 1: Operacionalización de Variables - Variable Independiente

VARIABLE DEPENDIENTE	DIMENSIONES	INDICADORES	MEDICIÓN
CARACTERÍSTICAS FÍSICAS DE LA PRESA	LEVANTAMIENTO TOPOGRÁFICO	ALTIMETRÍA	m.s.n.m.
		PLANIMETRÍA	m
	ESTUDIO HIDROLÓGICO	ÁREA	Km ²
		TIEMPO	hora
		CAUDAL	m ³ /s
		PENDIENTE	m/m
		PERÍMETRO	m
		VELOCIDAD	m/s

Tabla 2: Operacionalización de Variables - Variable Dependiente

III. METODOLOGÍA EMPLEADA

3.1. Tipo y Nivel de Investigación

3.1.1. Tipo de Investigación

Aplicada.

3.1.2. Nivel de Investigación

Descriptiva.

3.2. Población y Muestra de Estudio

3.2.1. Población

Río Chicama.

3.2.2. Muestra

Tramo Cojitambo – Chuquillanqui.

3.3. Diseño de Investigación

Experimental; debido a las características que presenta el estudio de investigación, ya que se emplearán diversos métodos y softwares para el desarrollo de esta.

3.4. Técnicas e instrumentos de Recolección de Datos

-Levantamiento Topográfico: Se tendrá que realizar un levantamiento topográfico de la zona para obtener datos precisos y útiles para la investigación.

-Observación: Se tendrá que ir a la zona de estudio para recolectar aquellos datos de campo que vayan a emplearse para el desarrollo de este.

-Análisis de Documentos: Se tendrá que revisar libros y artículos referidos a nuestro tema en estudio, proyecto de investigación similares y el uso del internet para buscar información importante que pueda ayudarnos a desarrollar este estudio de la mejor manera.

3.5. Procesamiento y Análisis de Datos

Para el procesamiento y análisis de los datos se optará por el uso de los siguientes softwares:

- **Microsoft Word 2019:** Se empleará para elaborar el informe final de la investigación.
- **Microsoft Excel 2019:** Se empleará para realizar las diversas hojas de cálculo y gráficos necesarios para el desarrollo del proyecto.
- **AutoCAD 2018:** Se empleará para importar los datos obtenidos en campo.
- **Civil 3D 2018:** Se empleará para facilitar el análisis de datos y para simplificar las tareas al realizar el levantamiento topográfico y en la cartografía.
- **ArcGIS 10.4:** Se empleará para recopilar, analizar y administrar la información geográfica que nos brinda este programa para beneficio de nuestro proyecto.
- **HEC-HMS:** Se empleará para el modelo hidráulico de la cuenca.
- **HYDROIIILA:** Se empleará para obtener la intensidad de lluvia en intervalos de tiempo.

IV. RESULTADOS

4.1. Modelo Digital de Elevación (DEM)

- La topografía fue obtenida desde la página web de Descarga de Información Espacial, para la cual fue necesario descargar el archivo “16 - f: Otuzco” de la Zona 17 en formato Shape (*.shp), obteniendo así las curvas de nivel de dicha ubicación.

4.2. Modelo del Embalse

- Para realizar el análisis del modelo del embalse se hizo uso del software Arc Map.
- De acuerdo a la topografía del lugar se procedió a elegir 3 posibles lugares adecuados para la construcción del embalse.



Ilustración 8: Ubicación de embalses.

4.2.1. Propuesta 1

4.2.1.1. Topografía

Ubicación: 7°33'4.436"S 78°46'43.449"W

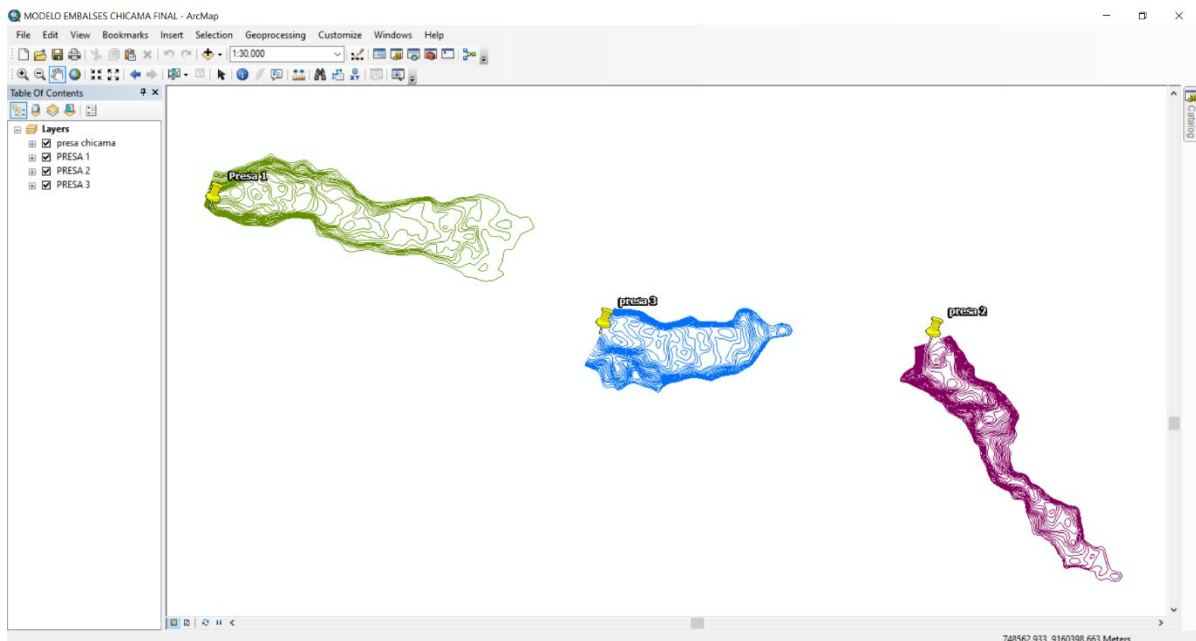
4.2.1.2. Curvas de Nivel



Ilustración 9: Curvas de Nivel de Embalse 1

4.2.1.3. Longitud de la Presa

Longitud: 366.91 m

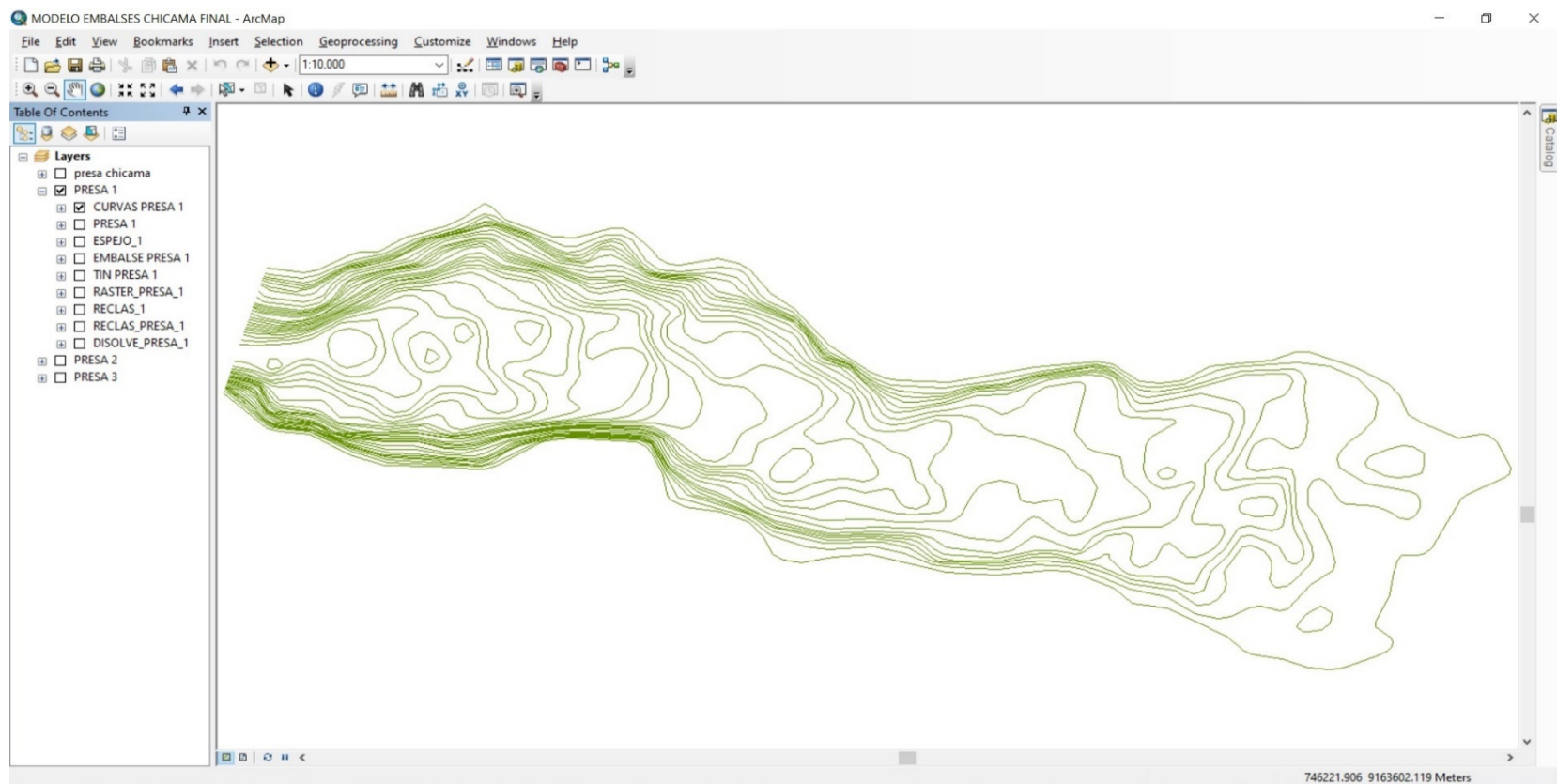

Ilustración 10: Longitud de la Presa 1

4.2.1.4. Contorno del Embalse

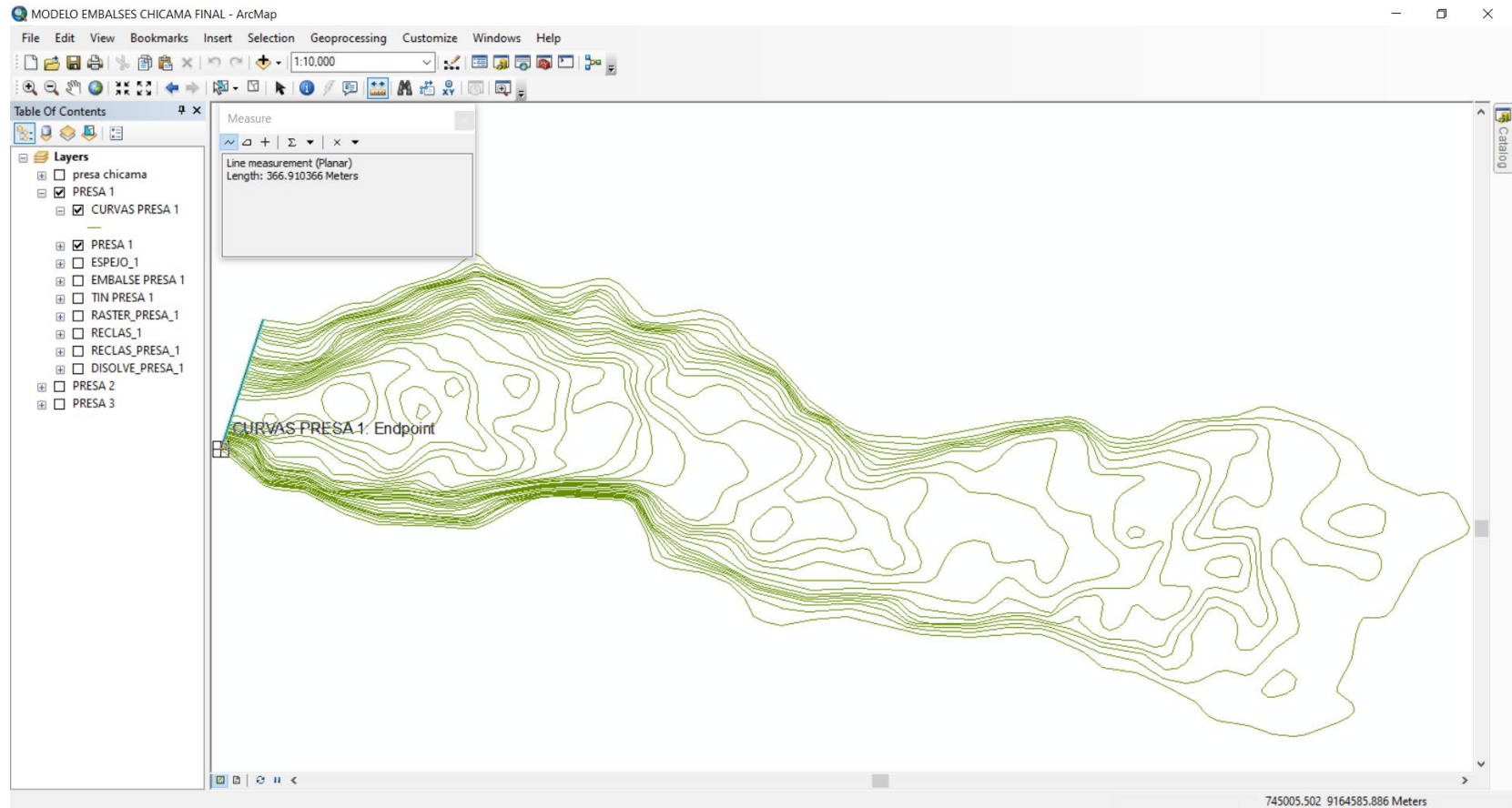

Ilustración 11: Contorno del Embalse 1

4.2.1.5. Espejo de Agua

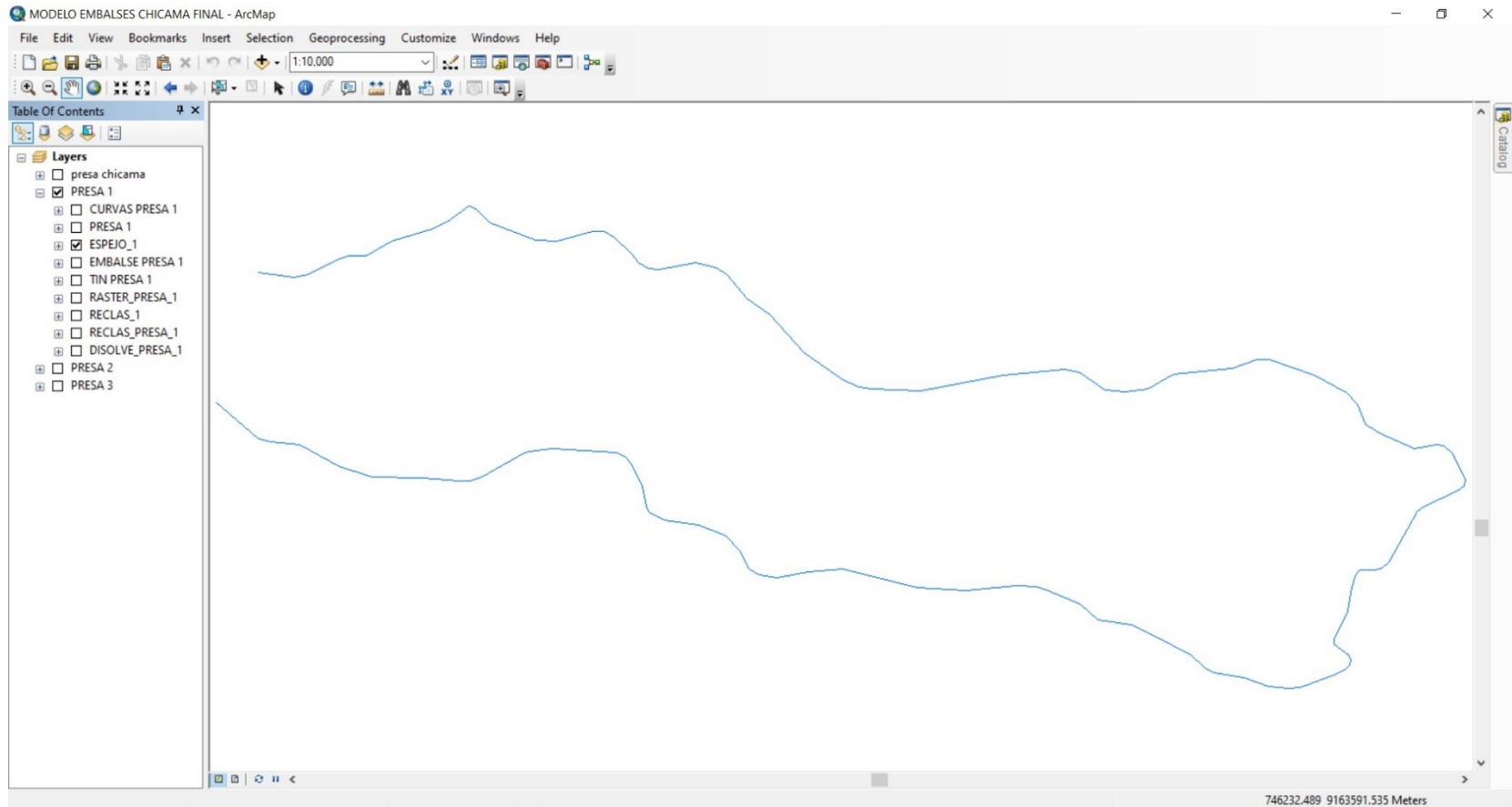

Ilustración 12: Espejo de Agua del Embalse 1

4.2.1.6. Creación del TIN

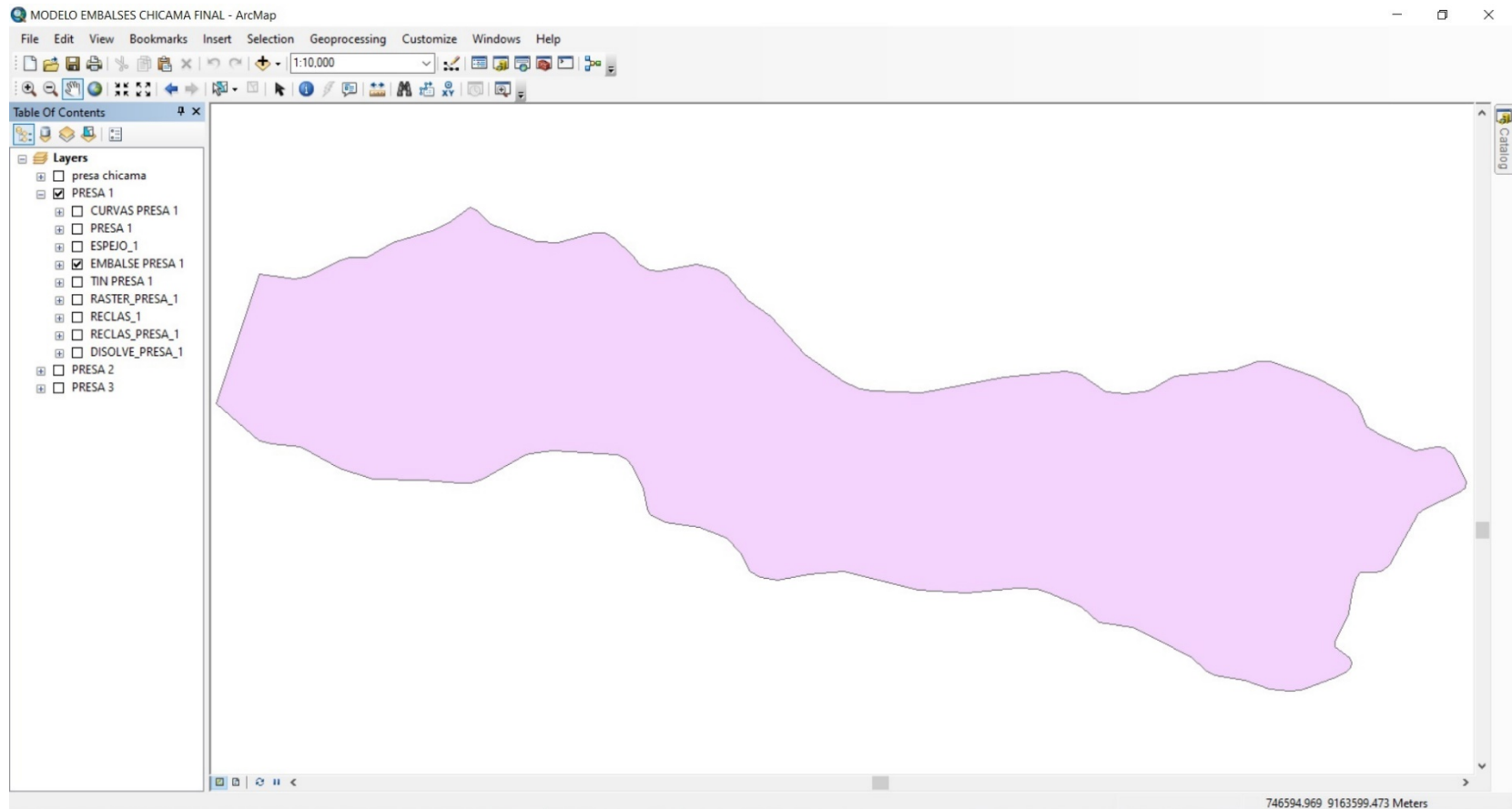

Ilustración 13: TIN del Embalse 1

4.2.1.7. Creación del Raster

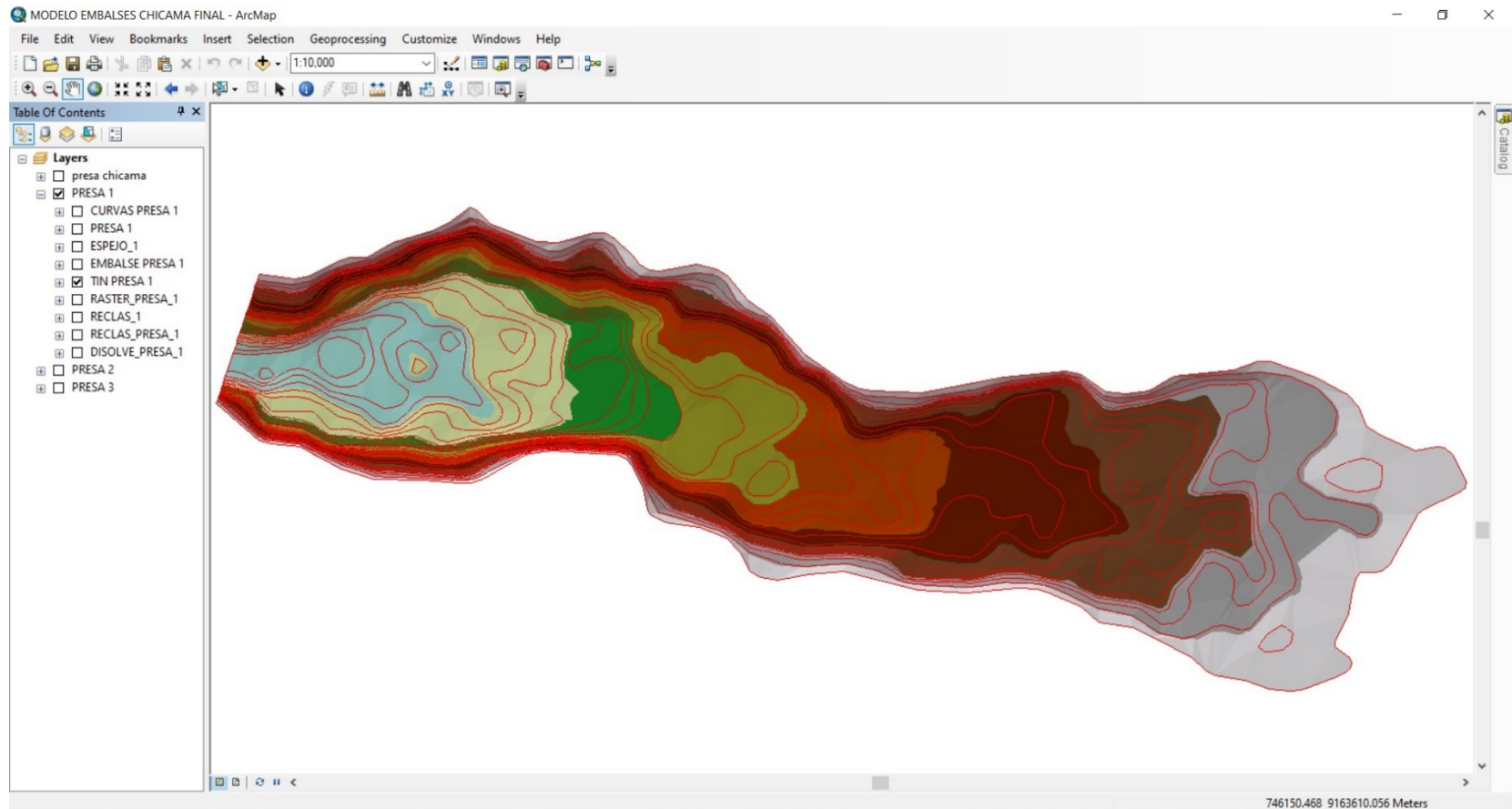

Ilustración 14: Raster del Embalse 1

4.2.1.8. Realizamos una Reclasificación de Alturas

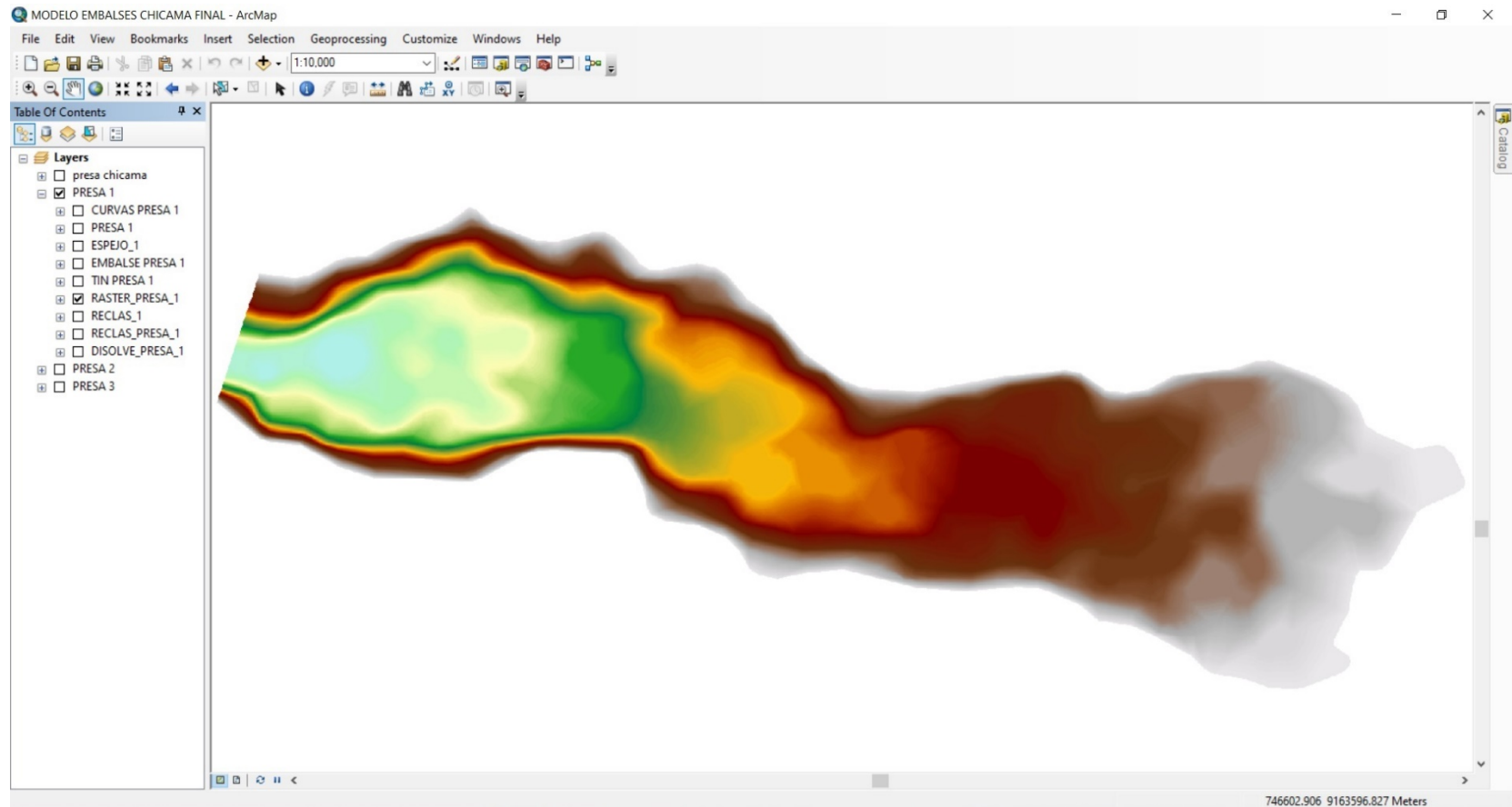

Ilustración 15: Reclasificación de Alturas del Embalse 1

4.2.1.9. Corrección de la Reclasificación con Altura = 1 metro

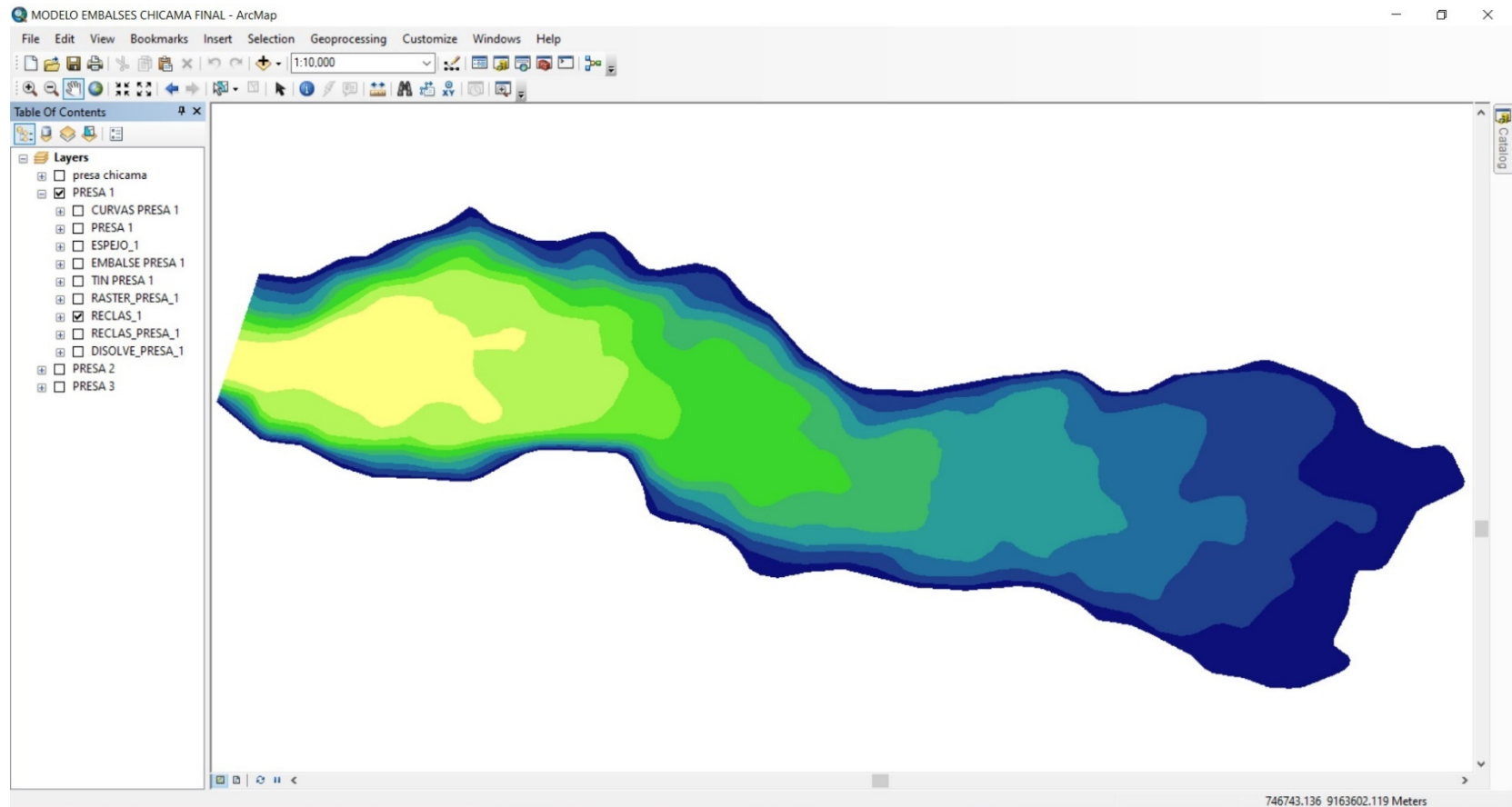

Ilustración 16: Reclasificación con Altura de 1m del Embalse 1

4.2.1.10. Aplicamos Dissolve

Esta herramienta nos permite simplificar los datos basándonos en un atributo de la capa que vamos a disolver. De esta manera podemos fusionar los polígonos cuyos valores son iguales en el campo de la tabla de atributos que seleccionemos.

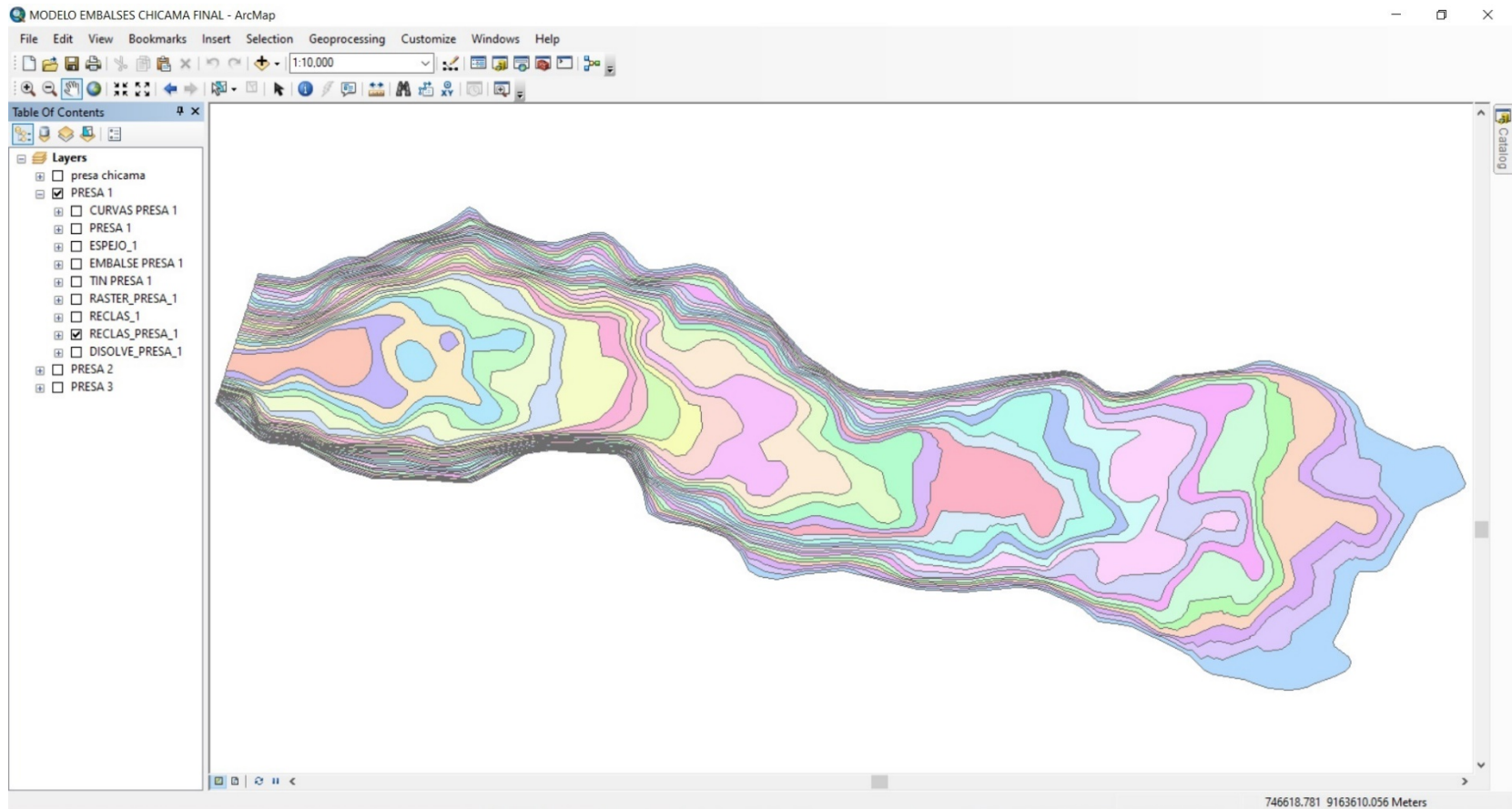

Ilustración 17: Dissolve del Embalse 1

4.2.1.11. Tabla de Atributos

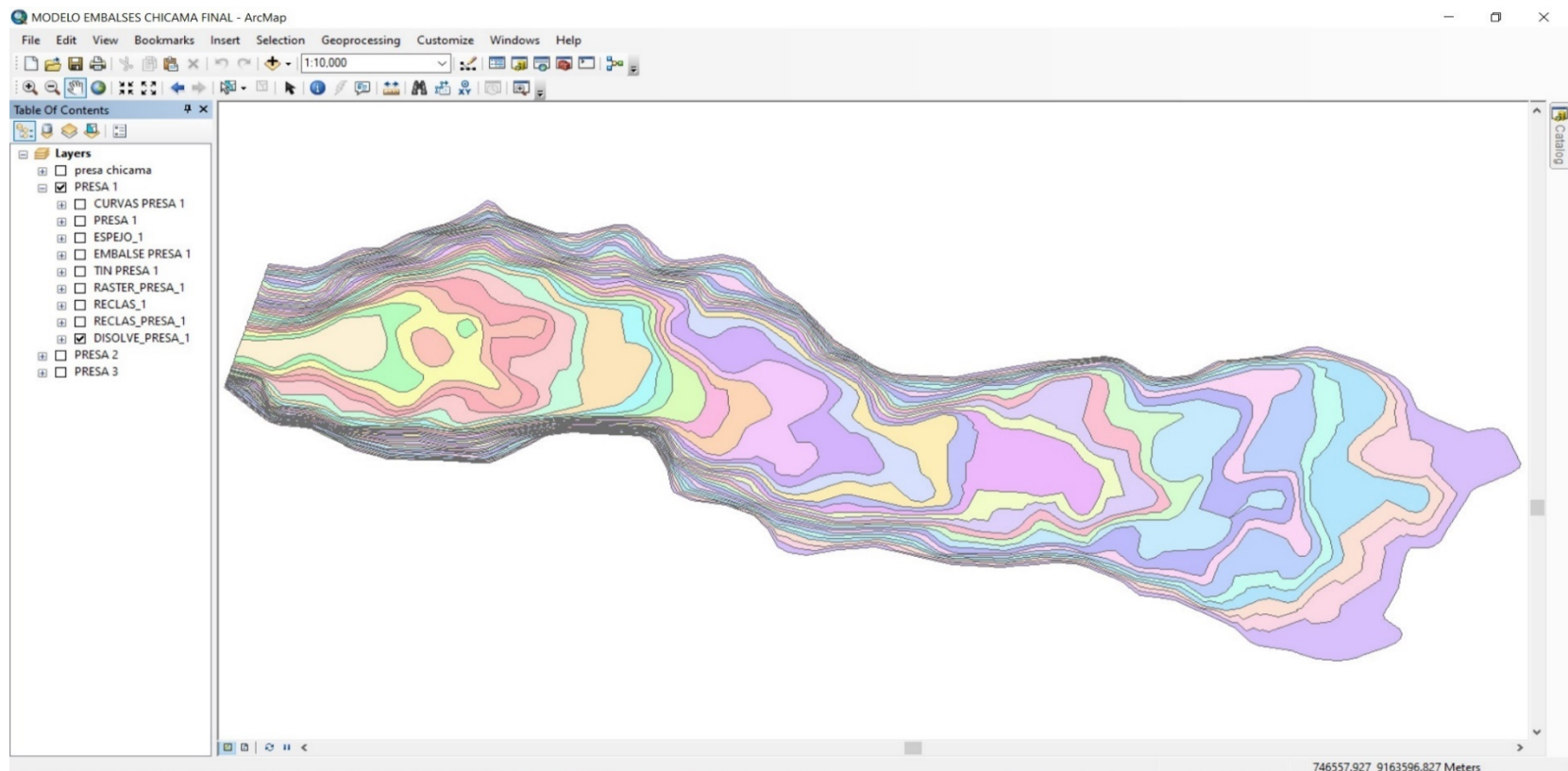

Ilustración 18: Tabla de Atributos del Embalse 1

4.2.2. Propuesta 2

4.2.2.1. Topografía

Ubicación: 7°33'48.142"S 78°42'44.057"W

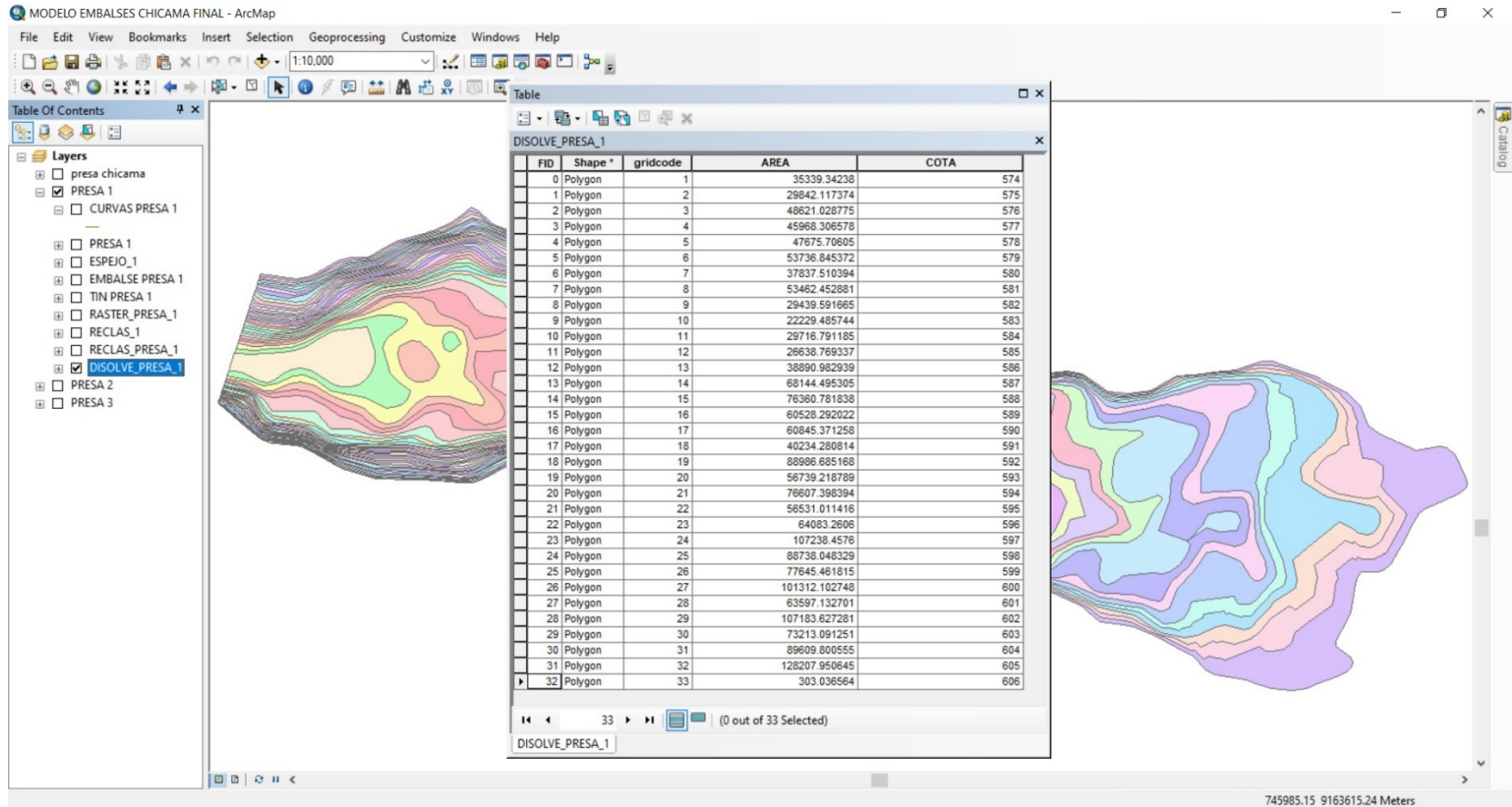
4.2.2.2. Curvas de Nivel



Ilustración 19: Curvas de Nivel de Embalse 2

4.2.2.3. Longitud de la Presa

Longitud: 380.90 m

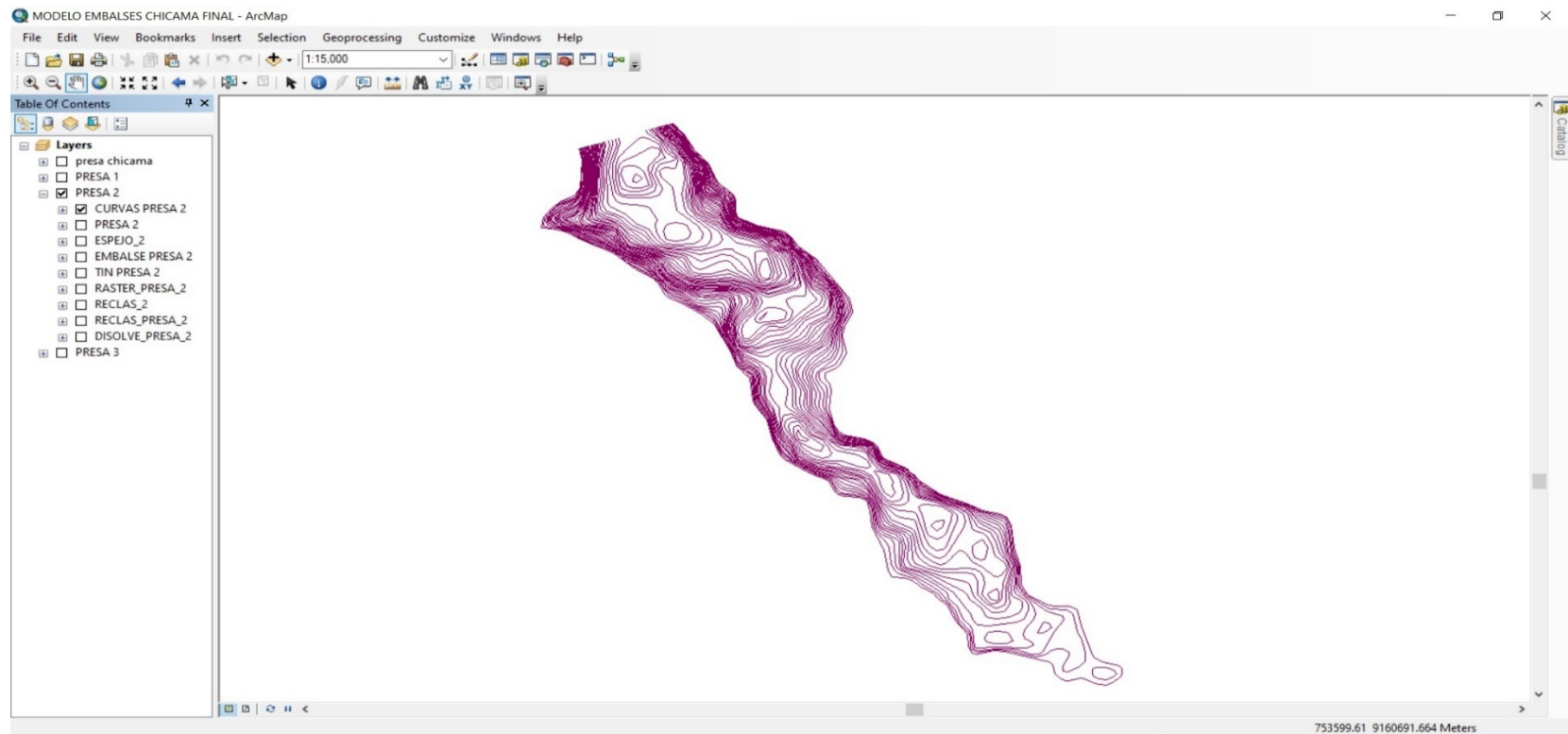

Ilustración 20: Longitud de la Presa 2

4.2.2.4. Contorno del Embalse

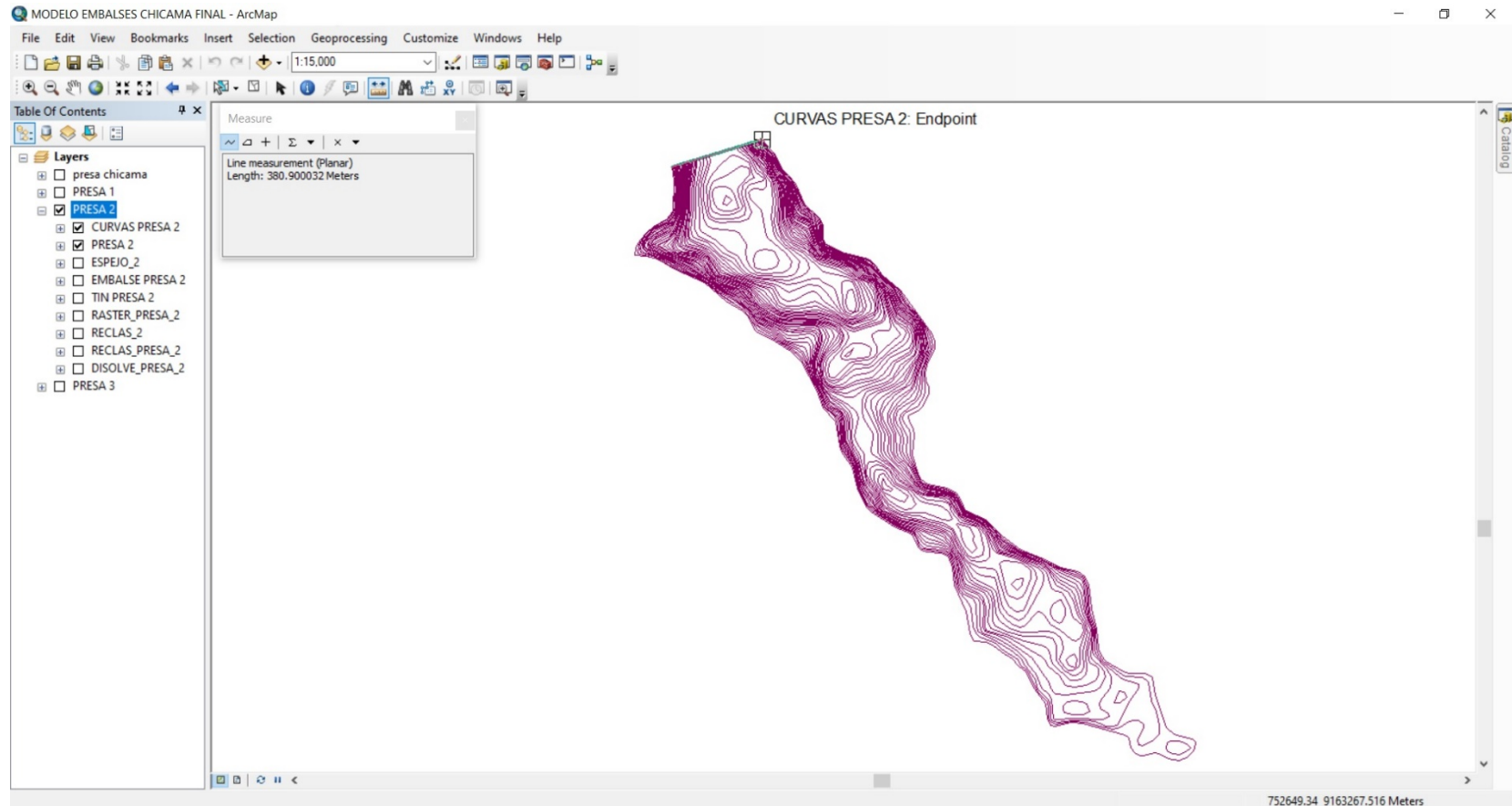

Ilustración 21: Contorno del Embalse 2

4.2.2.5. Espejo del Agua

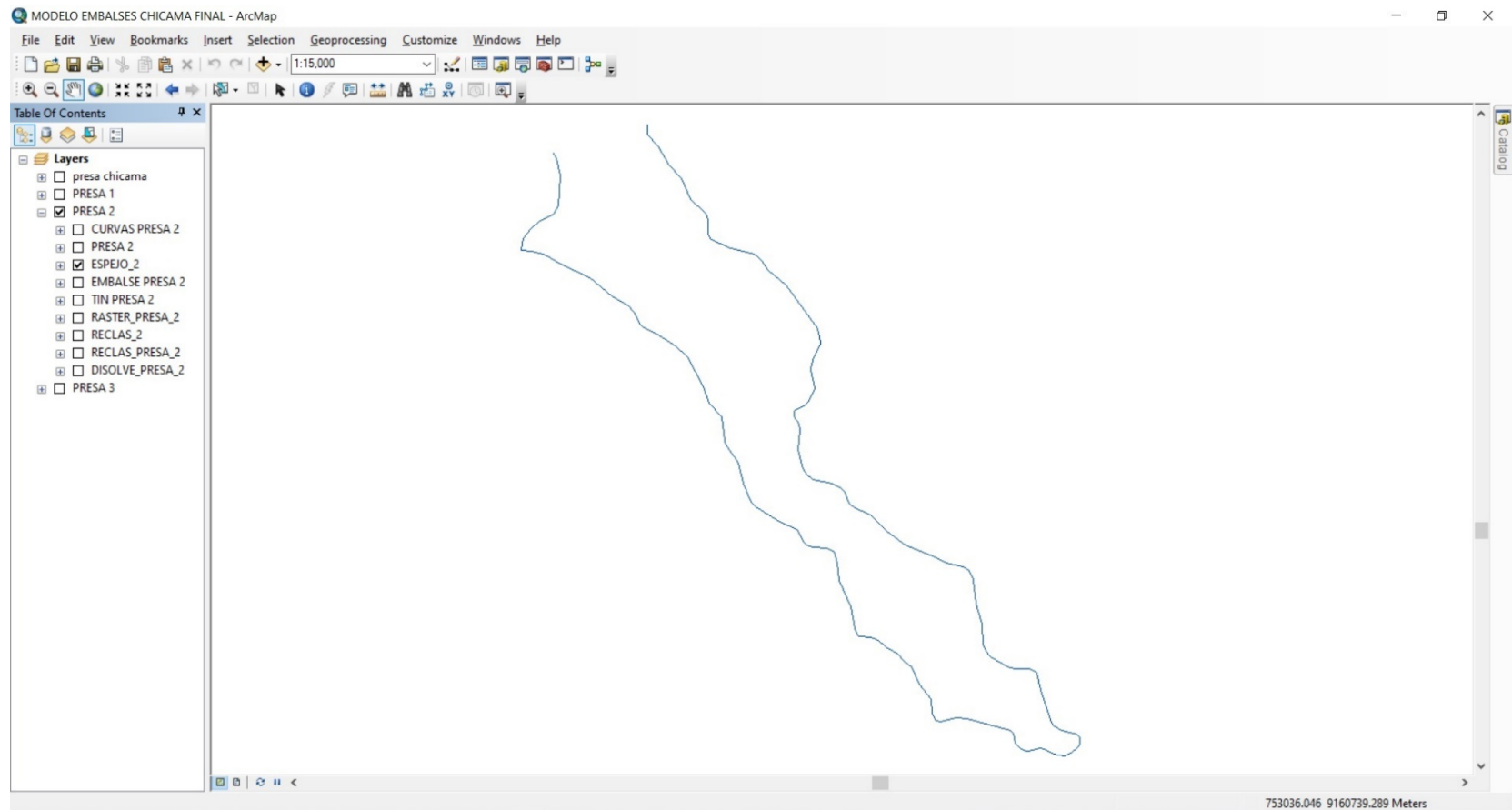

Ilustración 22: Espejo de Agua del Embalse 2

4.2.2.6. Creación del TIN

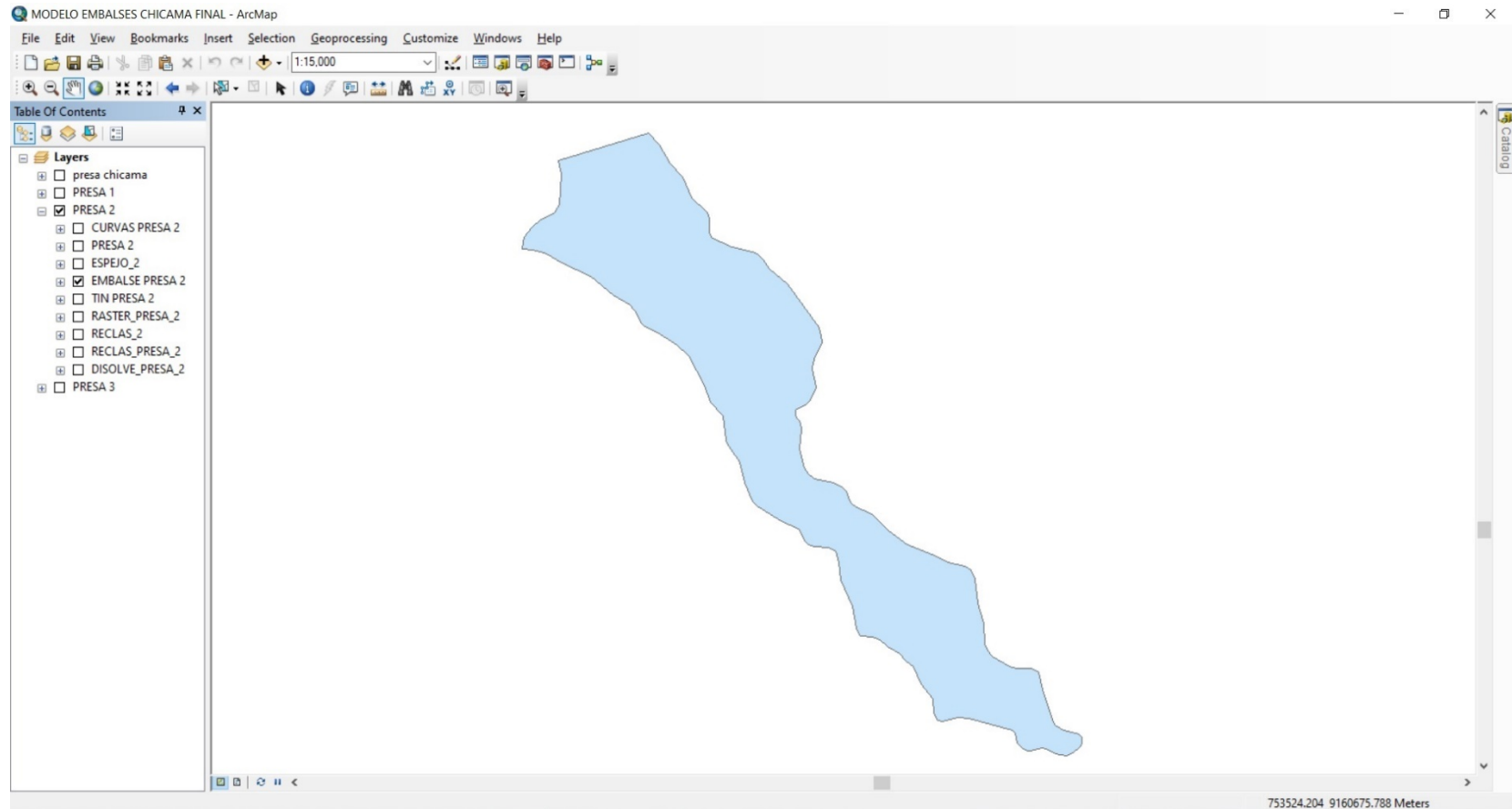

Ilustración 23: TIN del Embalse 2

4.2.2.7. Creación del Raster

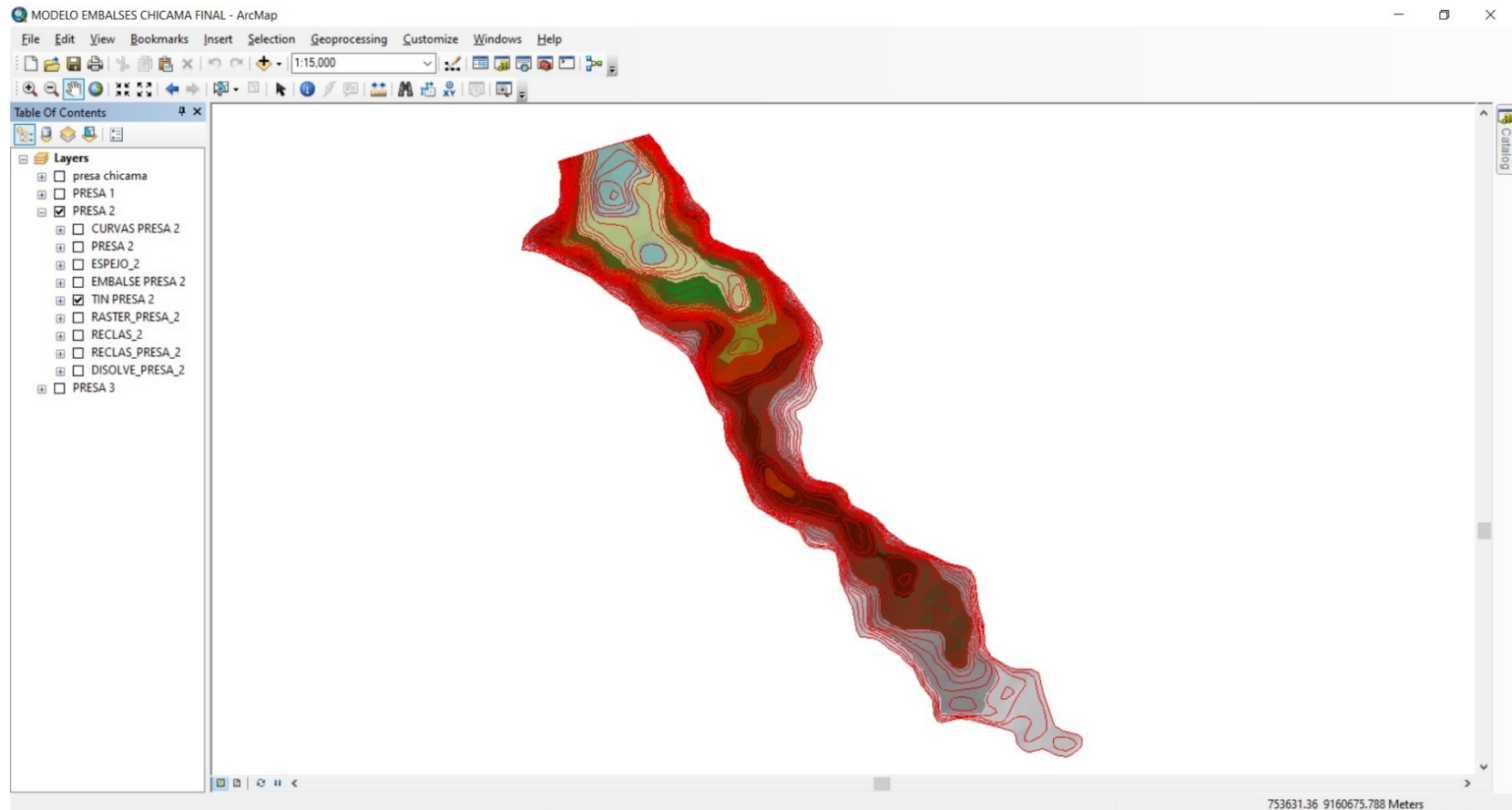

Ilustración 24: Raster del Embalse 2

4.2.2.8. Realizamos una Reclasificación de Alturas

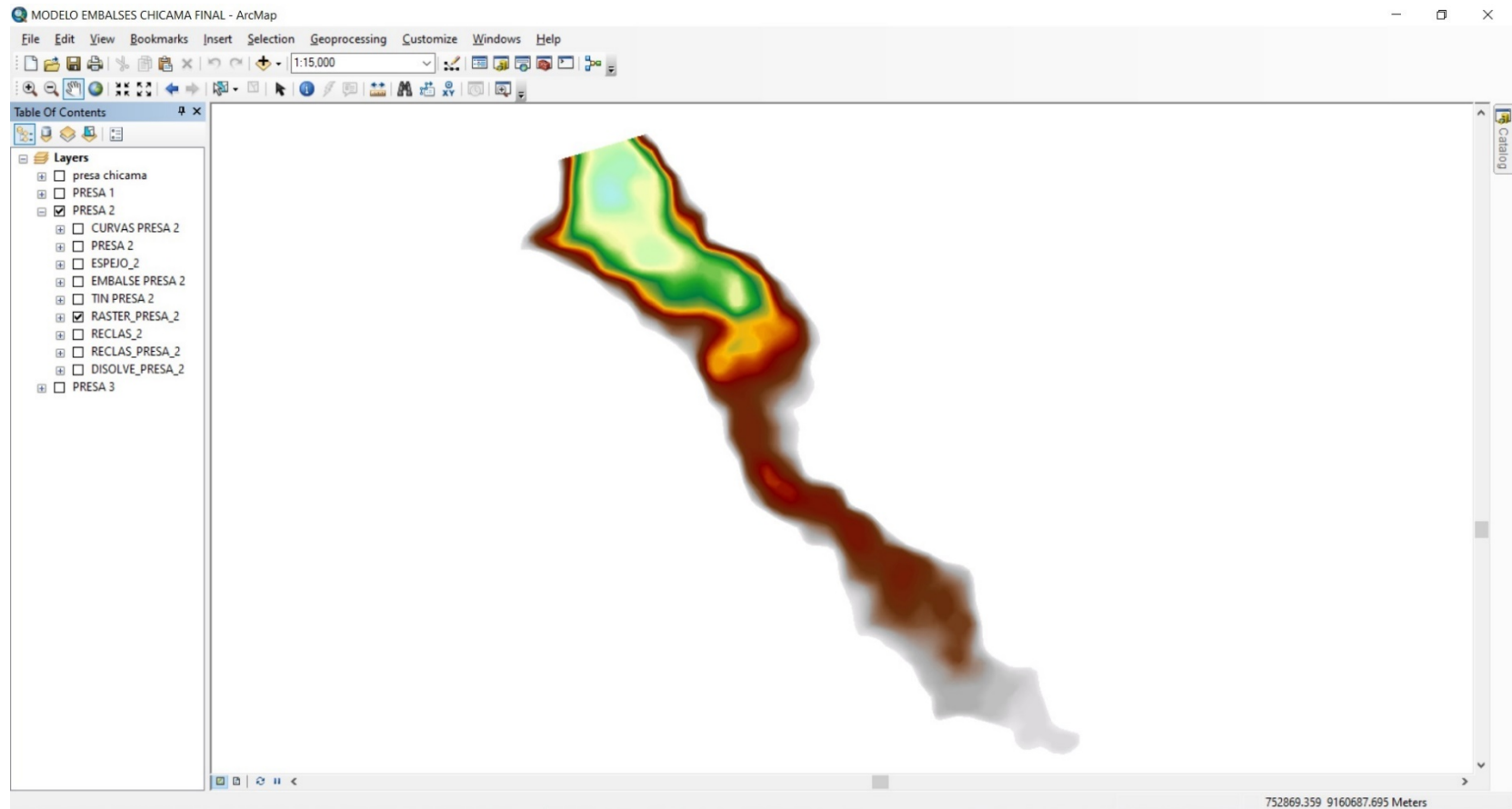

Ilustración 25: Reclasificación de Alturas del Embalse 2

4.2.2.9. Corrección de la Reclasificación con Altura = 1 metro

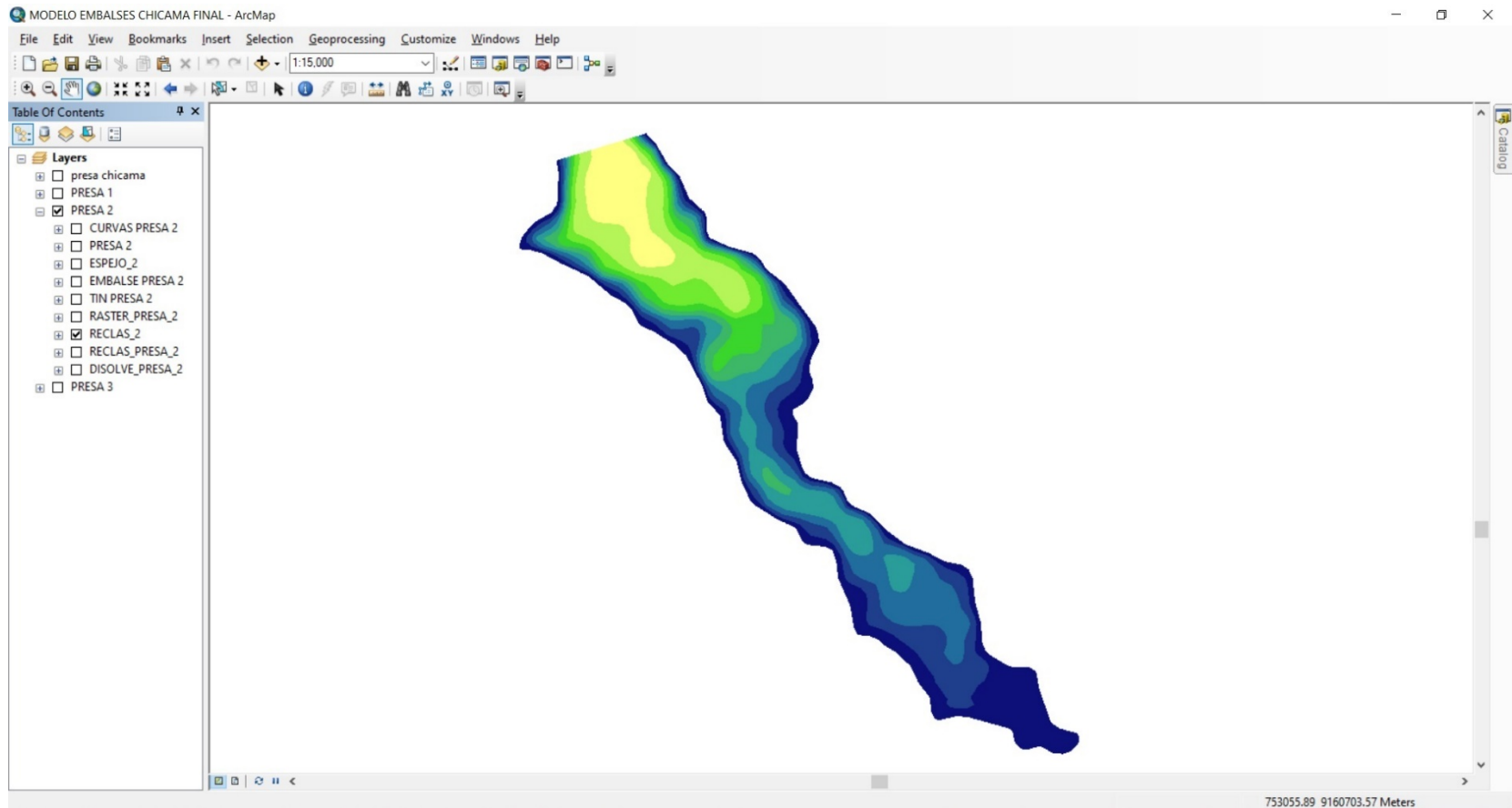

Ilustración 26: Reclasificación con Altura de 1m del Embalse 2

4.2.2.10. Aplicamos Dissolve

Esta herramienta nos permite simplificar los datos basándonos en un atributo de la capa que vamos a disolver. De esta manera podemos fusionar los polígonos cuyos valores son iguales en el campo de la tabla de atributos que seleccionemos.

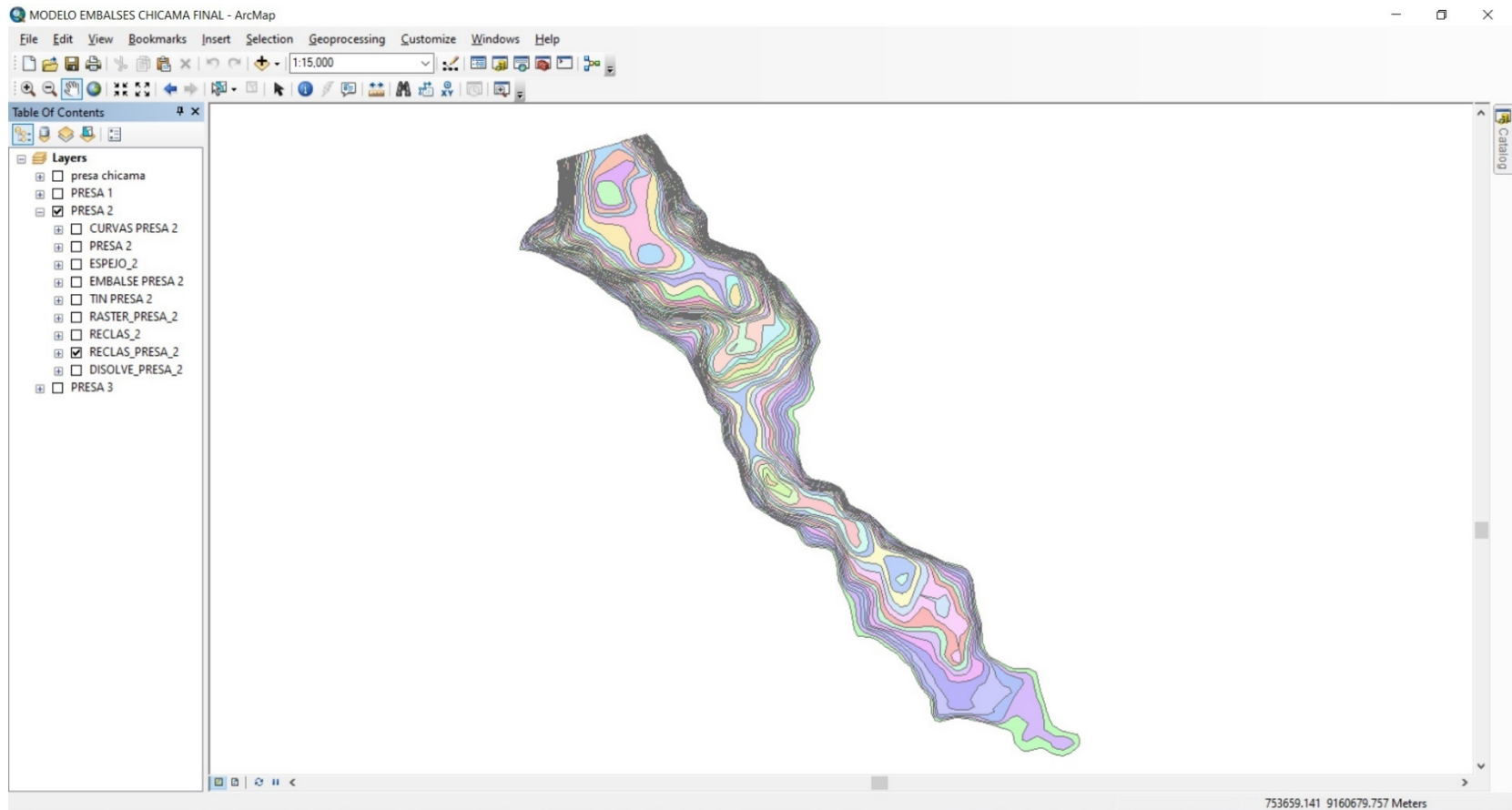

Ilustración 27: Dissolve del Embalse 2

4.2.2.11. Tabla de Atributos

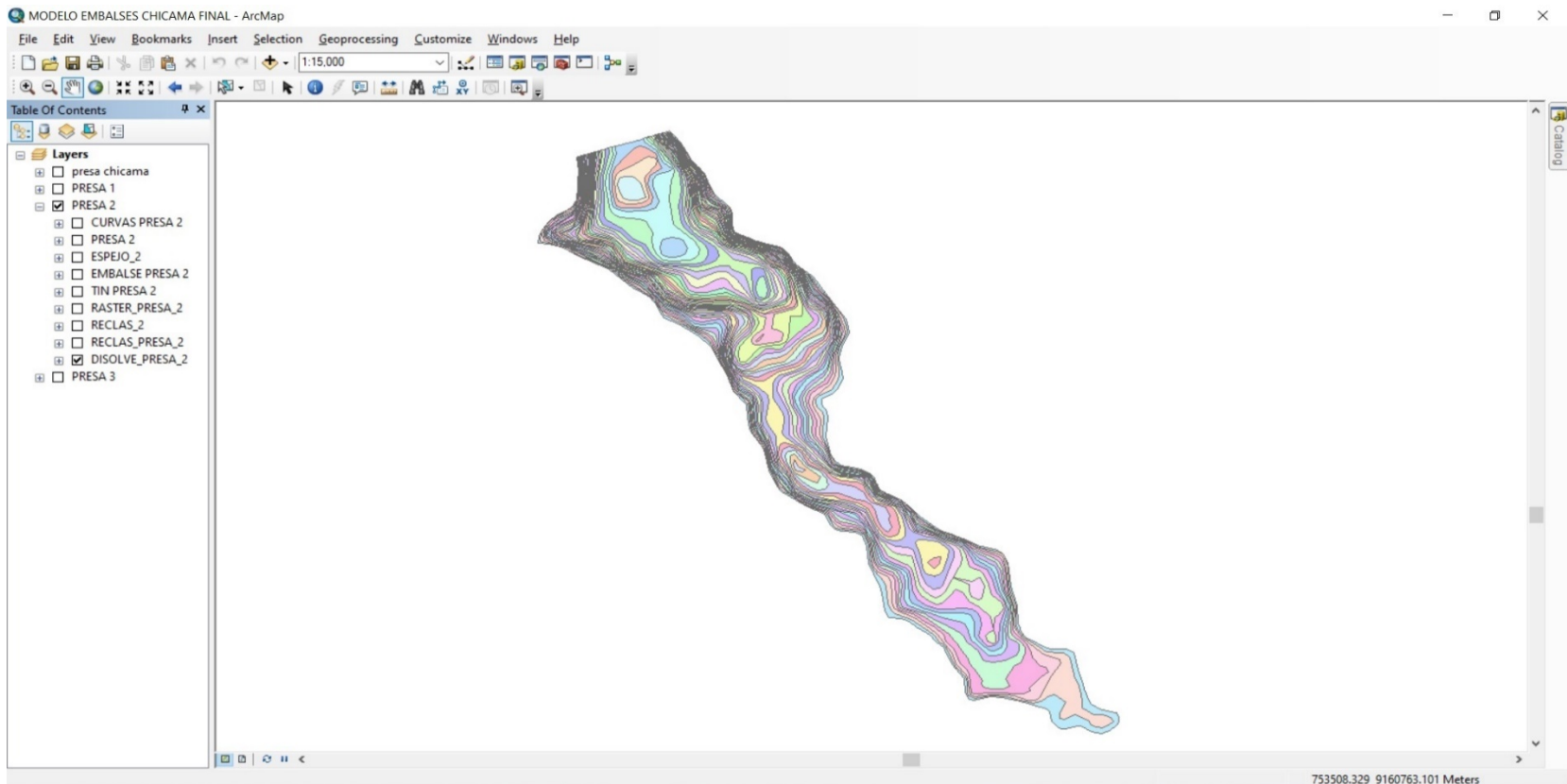

Ilustración 28: Tabla de Atributos del Embalse 2

4.2.3. Propuesta 3

4.2.3.1. Topografía

Ubicación: 7°33'45.609"S 78°44'32.782"W

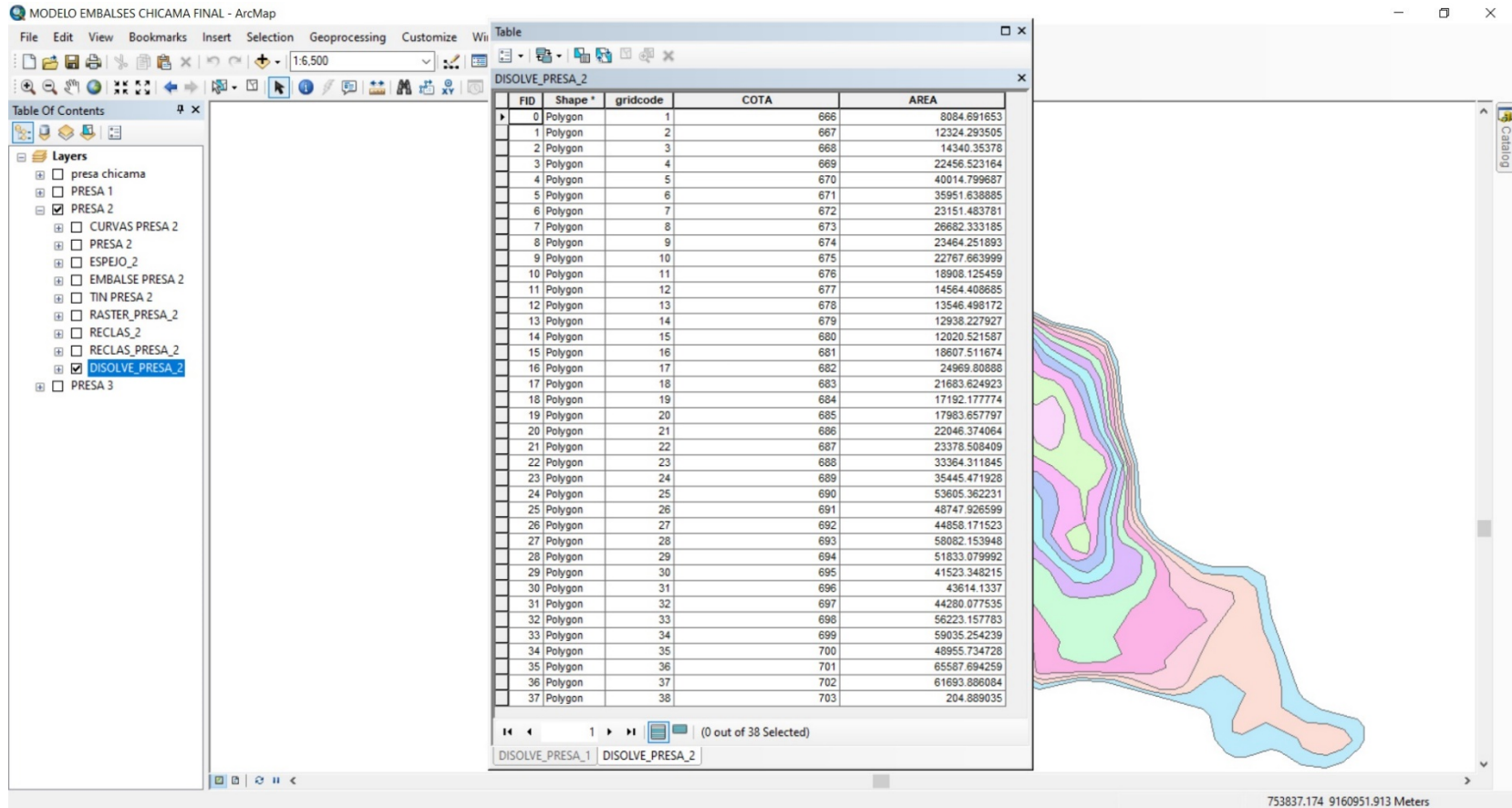
4.2.3.2. Curvas de Nivel



Ilustración 29: Curvas de Nivel del Embalse 3

4.2.3.3. Longitud de la Presa

Longitud: 656.26

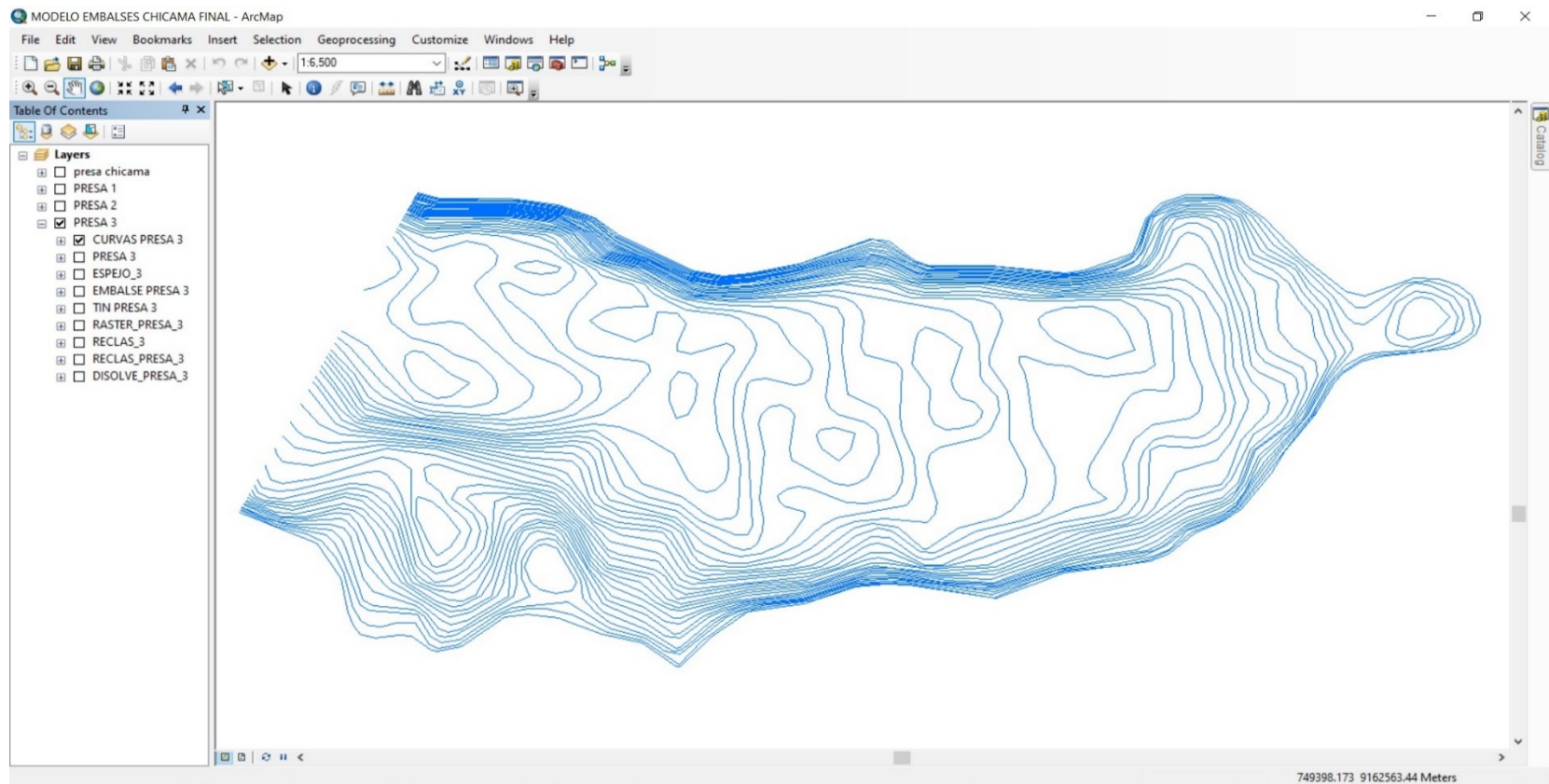

Ilustración 30: Longitud de la Presa 3

4.2.3.4. Contorno del Embalse

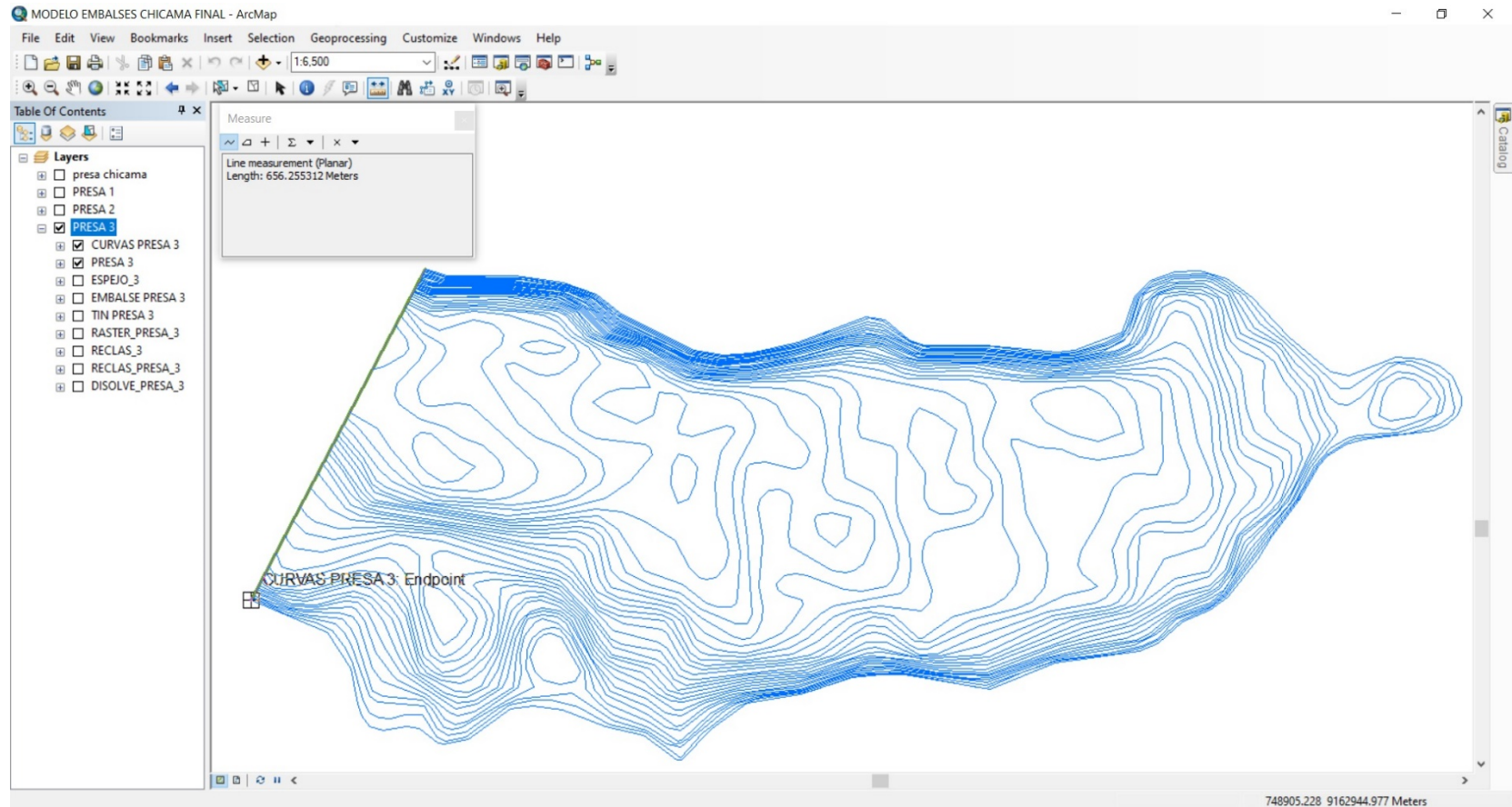

Ilustración 31: Contorno del Embalse 3

4.2.3.5. Espejo de Agua

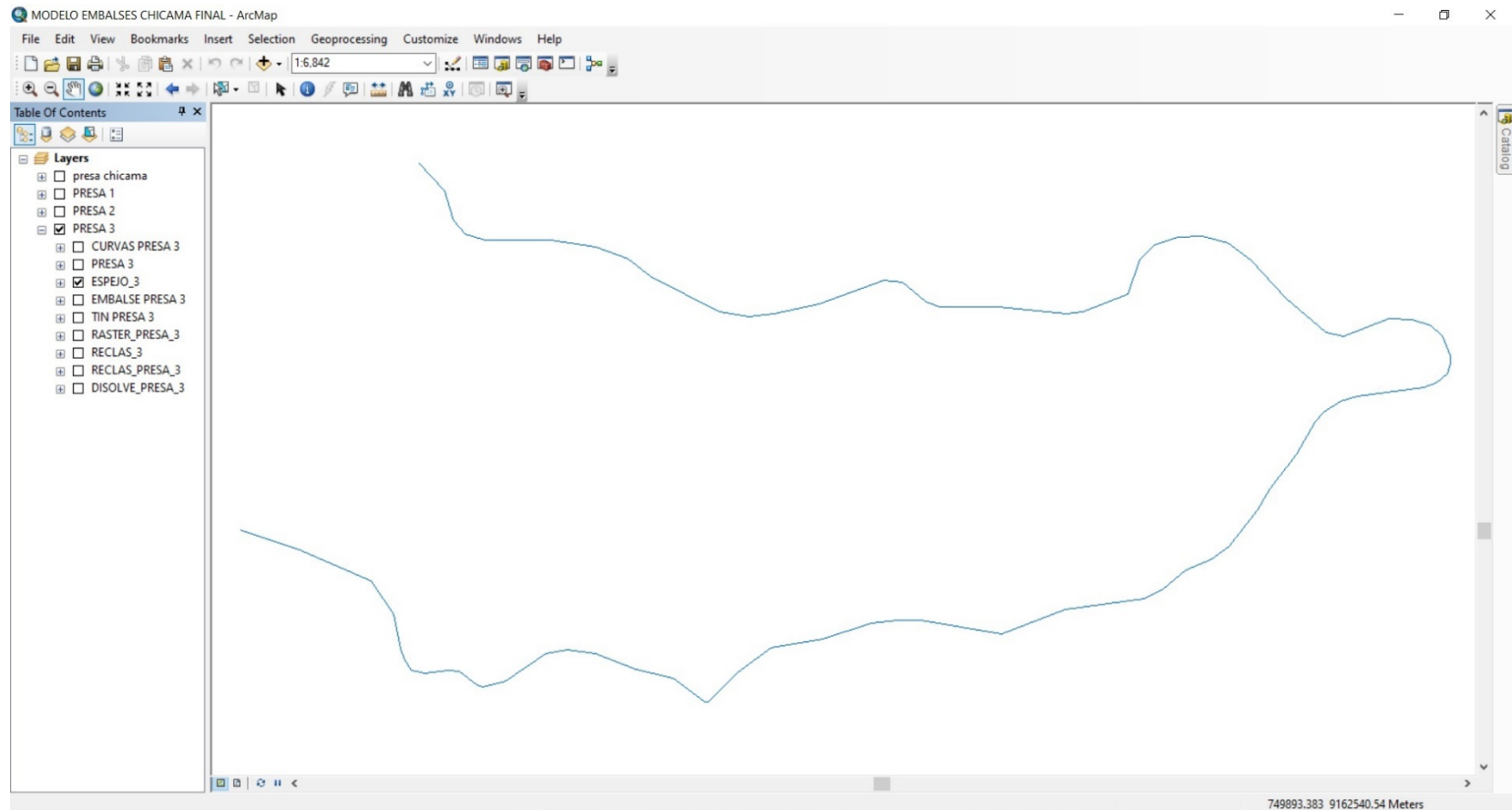

Ilustración 32: Espejo de Agua del Embalse 3

4.2.3.6. Creación del TIN

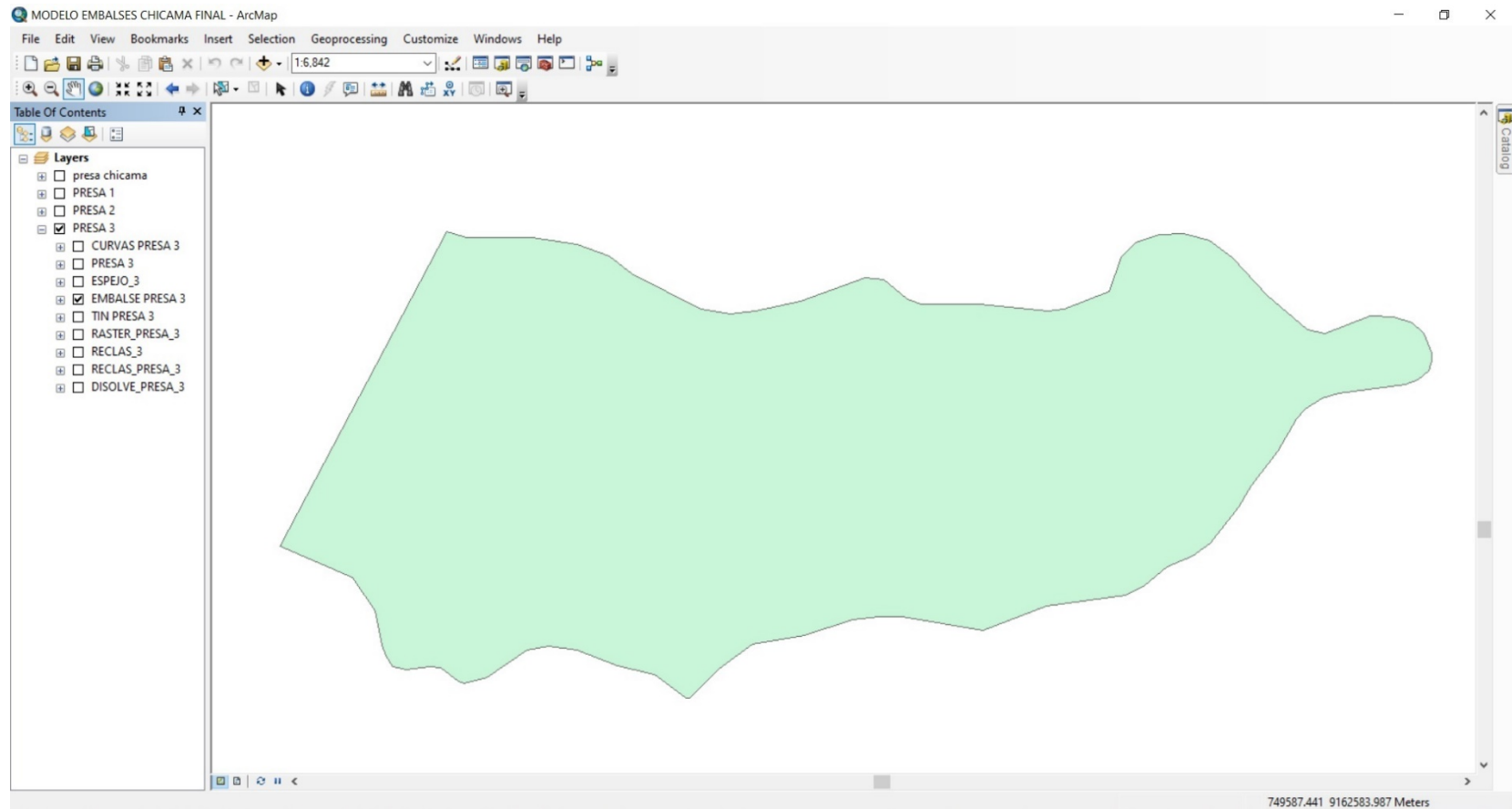

Ilustración 33: TIN del Embalse 3

4.2.3.7. Creación del Raster

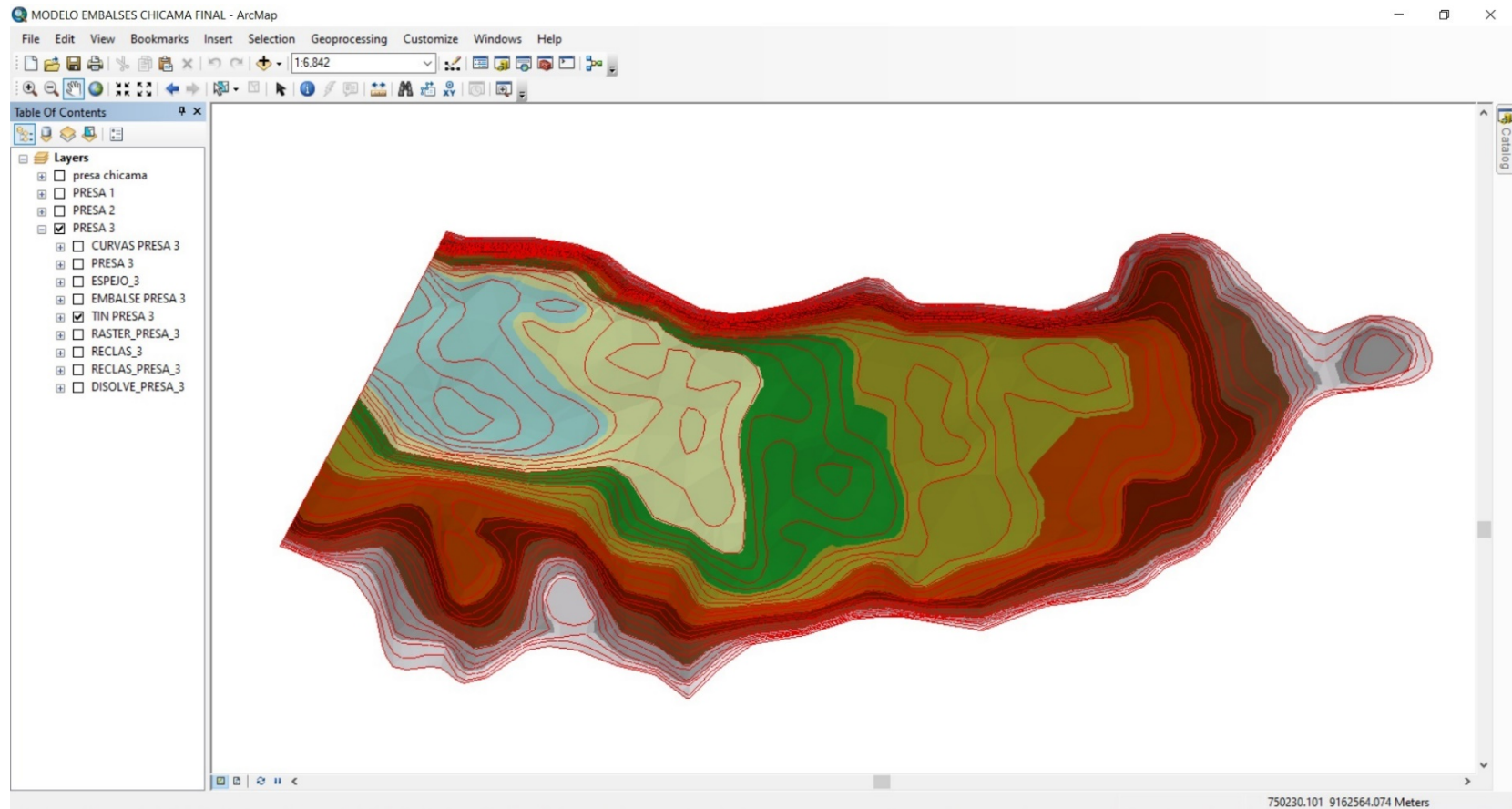

Ilustración 34: Raster del Embalse 3

4.2.3.8. Realizamos una Reclasificación de Alturas

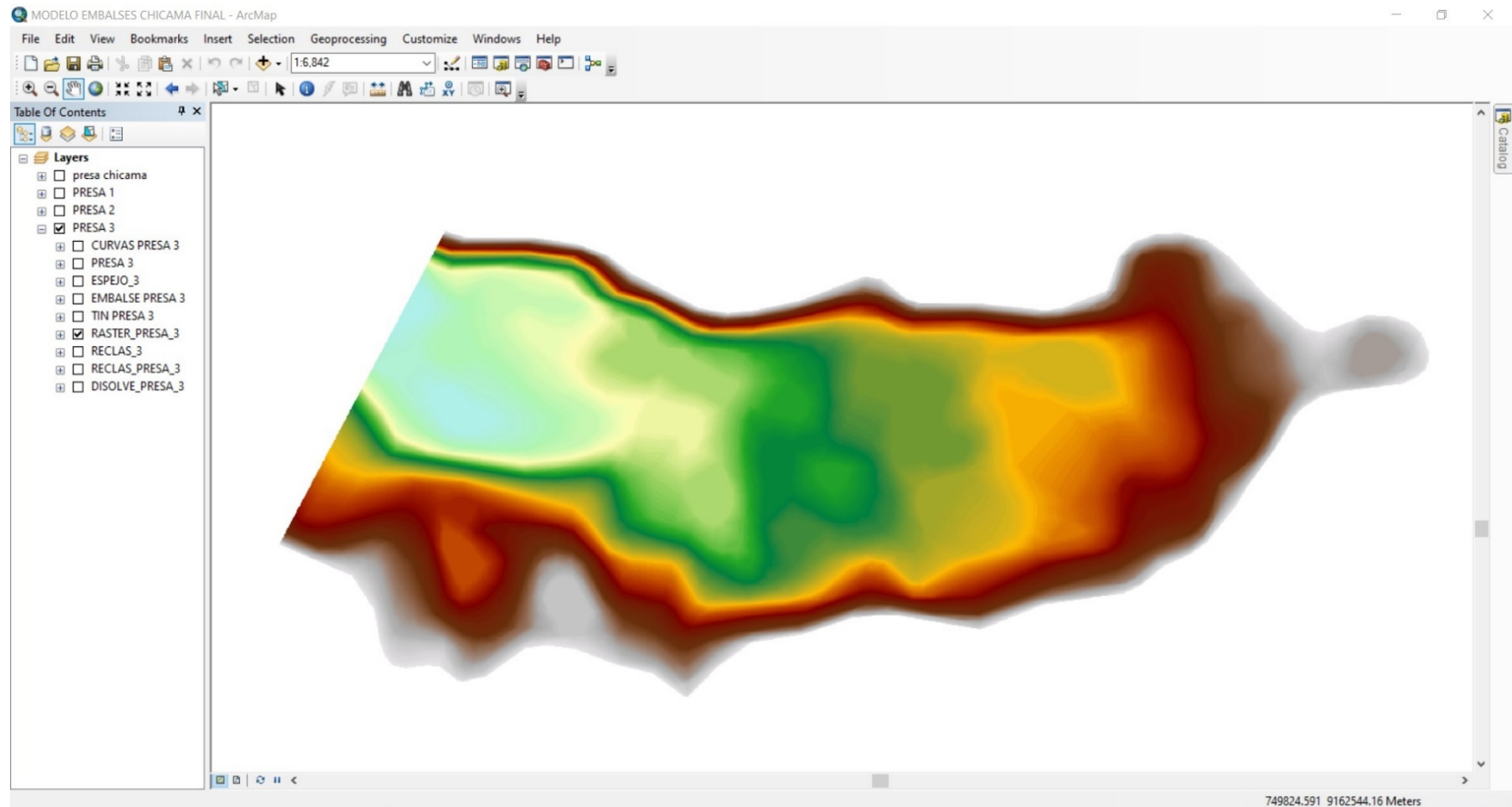

Ilustración 35: Reclasificación de Alturas del Embalse 3

4.2.3.9. Corrección de la Reclasificación con Altura = 1 metro

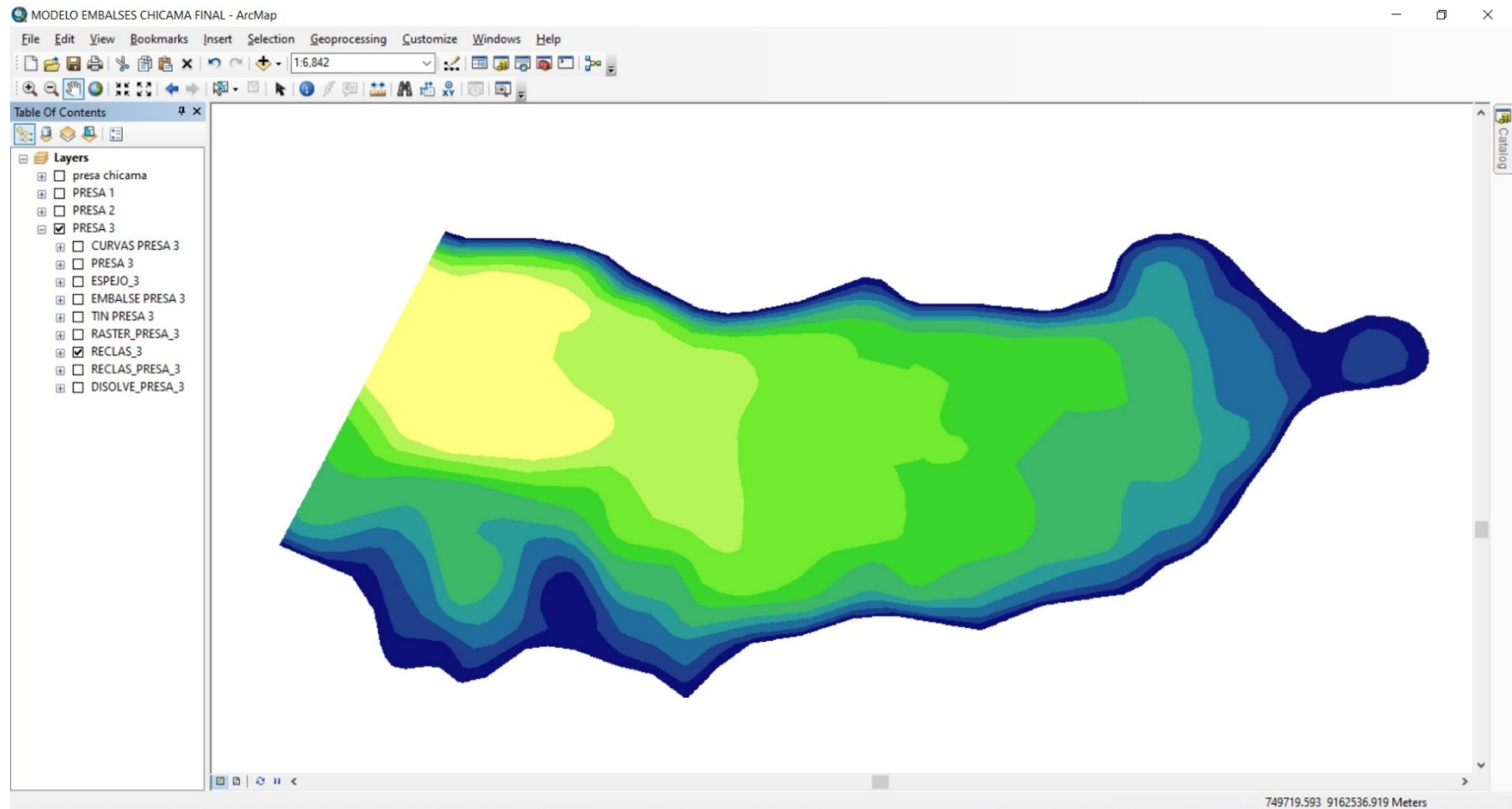

Ilustración 36: Reclasificación con Altura de 1m del Embalse 3

4.2.3.10. Aplicamos Dissolve

Esta herramienta nos permite simplificar los datos basándonos en un atributo de la capa que vamos a disolver. De esta manera podemos fusionar los polígonos cuyos valores son iguales en el campo de la tabla de atributos que seleccionemos.

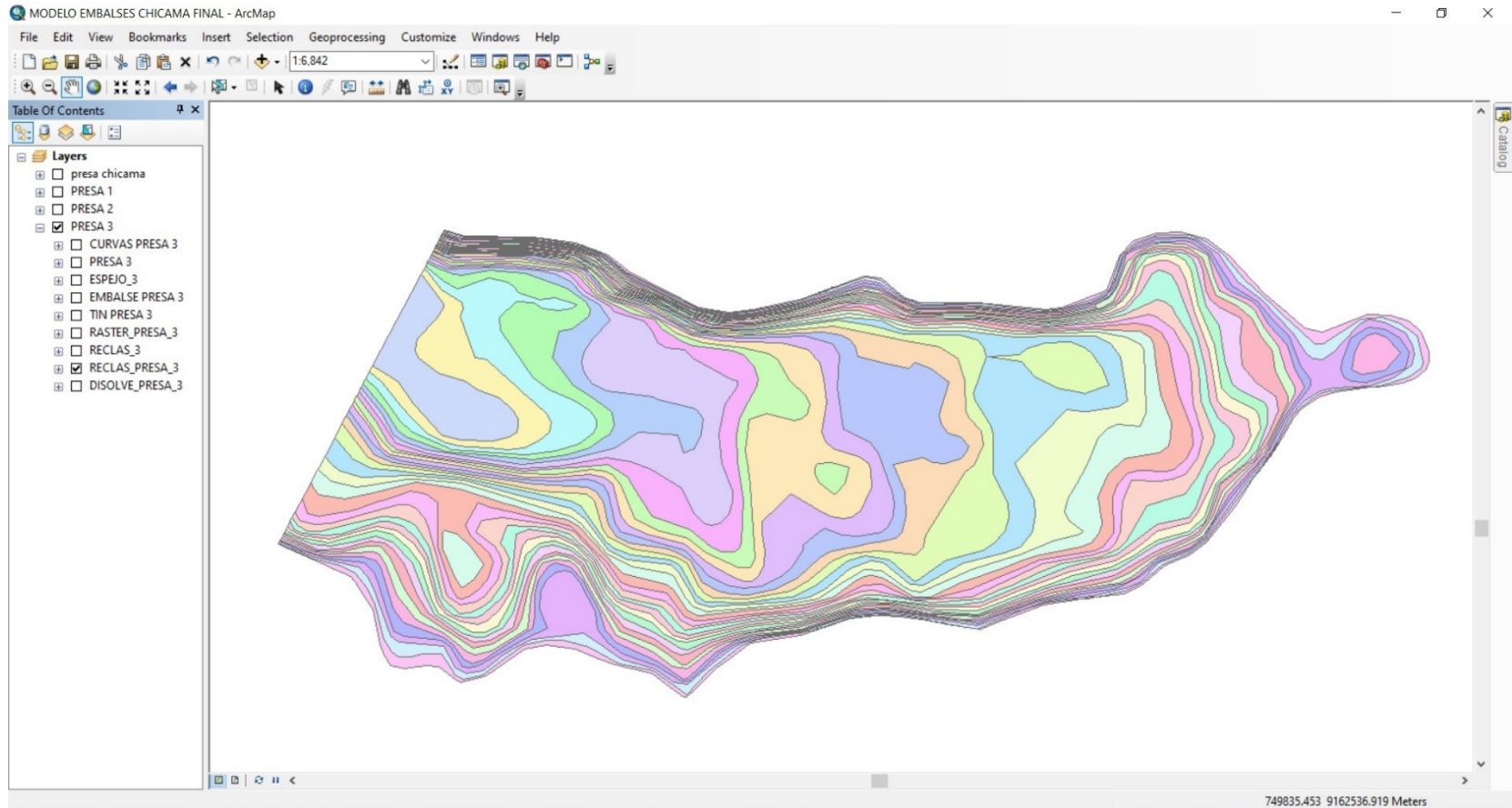

Ilustración 37: Dissolve del Embalse 3

4.2.3.11. Tabla de Atributos

The screenshot displays the ArcMap interface with a contour map of a reservoir. The 'Table' window is open, showing the attribute table for the 'DISOLVE_PRESA_3' layer. The table contains 32 rows of data, each representing a polygon with its unique FID, shape type, gridcode, COTA (elevation), and AREA (in square meters).

FID	Shape *	gridcode	COTA	AREA
0	Polygon	1	620	29604.627855
1	Polygon	2	621	25521.111156
2	Polygon	3	622	30987.883533
3	Polygon	4	623	29732.983057
4	Polygon	5	624	28338.351417
5	Polygon	6	625	55634.605168
6	Polygon	7	626	33529.833938
7	Polygon	8	627	30447.451357
8	Polygon	9	628	51797.921274
9	Polygon	10	629	42124.582888
10	Polygon	11	630	56502.049549
11	Polygon	12	631	44977.778245
12	Polygon	13	632	58781.368097
13	Polygon	14	633	60937.759044
14	Polygon	15	634	51682.522593
15	Polygon	16	635	49936.509326
16	Polygon	17	636	48856.524279
17	Polygon	18	637	36829.892582
18	Polygon	19	638	37538.331058
19	Polygon	20	639	34595.056797
20	Polygon	21	640	28724.111984
21	Polygon	22	641	28506.10285
22	Polygon	23	642	25376.170458
23	Polygon	24	643	27458.689886
24	Polygon	25	644	27315.789613
25	Polygon	26	645	23983.455117
26	Polygon	27	646	27869.124451
27	Polygon	28	647	27393.860688
28	Polygon	29	648	36012.282399
29	Polygon	30	649	26196.42781
30	Polygon	31	650	21703.746463
31	Polygon	32	651	103.783704

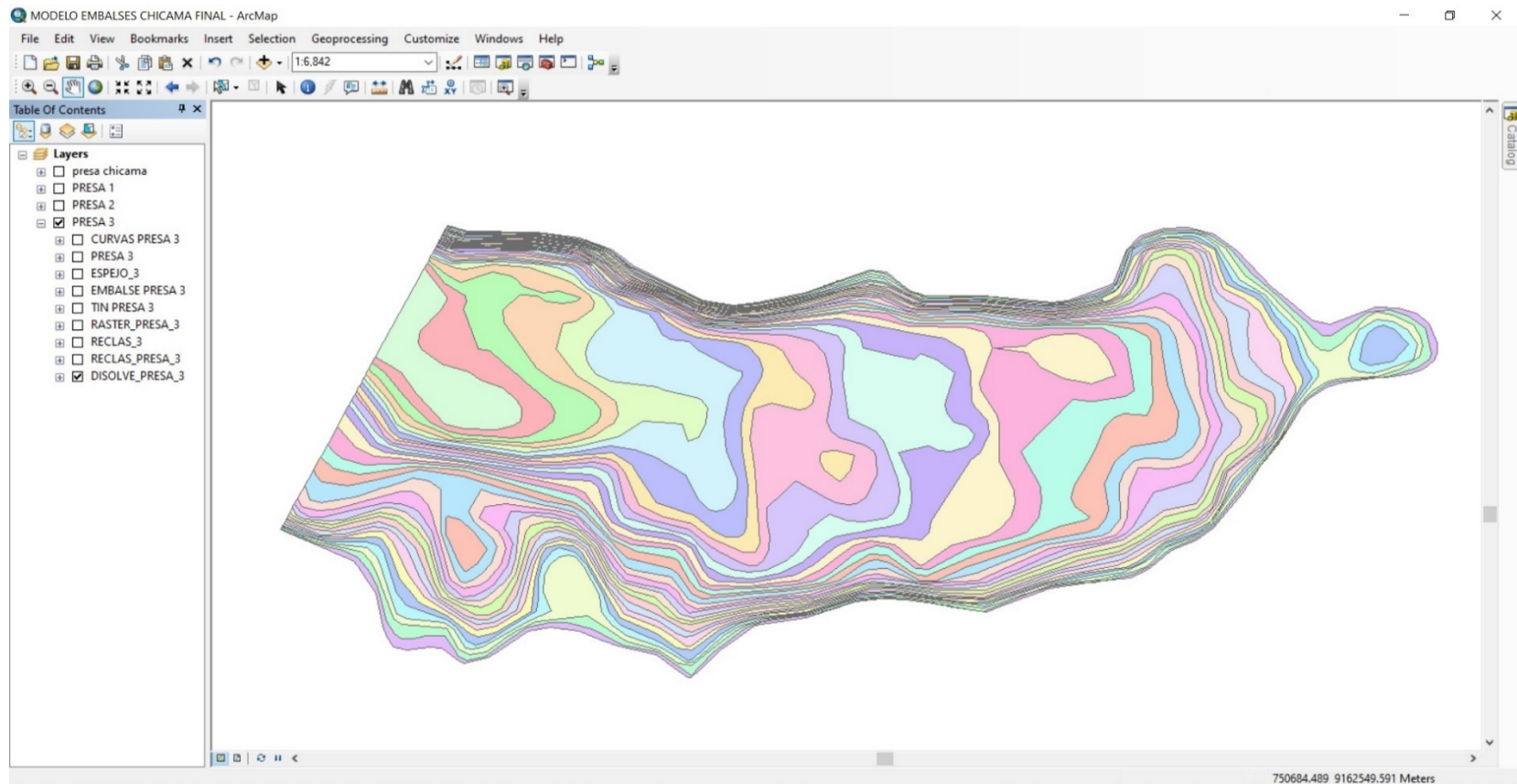
Ilustración 38: Tabla de Atributos del Embalse 3

4.3. Curva Cota – Área – Volumen

4.3.1. Embalse 1

4.3.1.1. Cálculos

ALTURA (m)	COTA (msnm)	AREA PARCIAL (m2)	AREA ACUMULADA (m2)	AREA MEDIA (m2)	VOLUMEN (m3)	VOLUMEN ACUMULADO (m3)	VOLUMEN ACUMULADO (MMC)
0	573	0.00	0.00	0.00	0.00	0.00	0.00
1	574	35,339.34	35,339.34	17,669.67	17,669.67	17,669.67	0.02
2	575	29,842.12	65,181.46	50,260.40	50,260.40	67,930.07	0.07
3	576	48,621.03	113,802.49	89,491.97	89,491.97	157,422.05	0.16
4	577	45,968.31	159,770.80	136,786.64	136,786.64	294,208.69	0.29
5	578	47,675.71	207,446.50	183,608.65	183,608.65	477,817.34	0.48
6	579	53,736.85	261,183.35	234,314.92	234,314.92	712,132.26	0.71
7	580	37,837.51	299,020.86	280,102.10	280,102.10	992,234.36	0.99
8	581	53,462.45	352,483.31	325,752.08	325,752.08	1,317,986.45	1.32
9	582	29,439.59	381,922.90	367,203.11	367,203.11	1,685,189.55	1.69
10	583	22,229.49	404,152.39	393,037.64	393,037.64	2,078,227.20	2.08
11	584	29,716.79	433,869.18	419,010.78	419,010.78	2,497,237.98	2.50
12	585	26,638.77	460,507.95	447,188.56	447,188.56	2,944,426.54	2.94
13	586	38,890.98	499,398.93	479,953.44	479,953.44	3,424,379.98	3.42
14	587	68,144.50	567,543.43	533,471.18	533,471.18	3,957,851.16	3.96
15	588	76,360.78	643,904.21	605,723.82	605,723.82	4,563,574.98	4.56
16	589	60,528.29	704,432.50	674,168.35	674,168.35	5,237,743.33	5.24
17	590	60,845.37	765,277.87	734,855.19	734,855.19	5,972,598.51	5.97
18	591	40,234.28	805,512.15	785,395.01	785,395.01	6,757,993.53	6.76
19	592	88,986.69	894,498.84	850,005.49	850,005.49	7,607,999.02	7.61
20	593	56,739.22	951,238.06	922,868.45	922,868.45	8,530,867.47	8.53
21	594	76,607.40	1,027,845.45	989,541.76	989,541.76	9,520,409.22	9.52
22	595	56,531.01	1,084,376.47	1,056,110.96	1,056,110.96	10,576,520.18	10.58
23	596	64,083.26	1,148,459.73	1,116,418.10	1,116,418.10	11,692,938.28	11.69
24	597	107,238.46	1,255,698.18	1,202,078.96	1,202,078.96	12,895,017.23	12.90
25	598	88,738.05	1,344,436.23	1,300,067.21	1,300,067.21	14,195,084.44	14.20
26	599	77,645.46	1,422,081.69	1,383,258.96	1,383,258.96	15,578,343.40	15.58
27	600	101,312.10	1,523,393.80	1,472,737.75	1,472,737.75	17,051,081.15	17.05
28	601	63,597.13	1,586,990.93	1,555,192.36	1,555,192.36	18,606,273.51	18.61
29	602	107,183.63	1,694,174.56	1,640,582.74	1,640,582.74	20,246,856.26	20.25
30	603	73,213.09	1,767,387.65	1,730,781.10	1,730,781.10	21,977,637.36	21.98
31	604	89,609.80	1,856,997.45	1,812,192.55	1,812,192.55	23,789,829.91	23.79
32	605	128,207.95	1,985,205.40	1,921,101.42	1,921,101.42	25,710,931.33	25.71

Tabla 3: Cálculos de Volumen Acumulado del Embalse 1

4.3.1.2. Gráfico Curva Cota-Área-Volumen



Gráfico 1: Curva Cota - Área - Volumen del Embalse 1

4.3.1.3. N vs Q

$$Q = \frac{2}{3} \sqrt{2g} \cdot Cd \cdot L \cdot H^{3/2} \quad N = \frac{Q}{2} + \frac{S}{\Delta t}$$

4.3.1.3.1. L=25

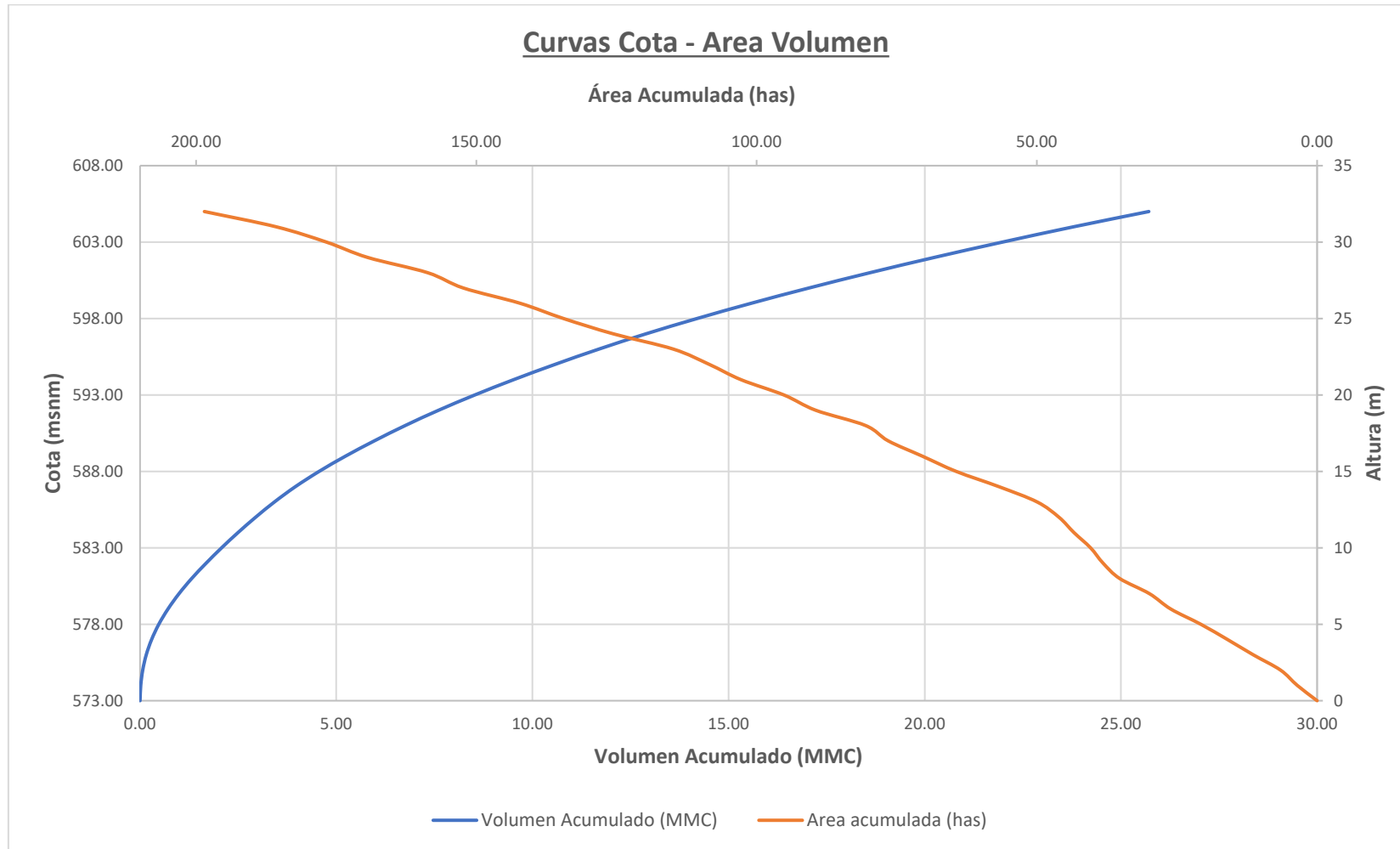
a) Cálculo

Cd =	0.75
L =	25.00

Tabla 4: Coeficiente para el Cálculo de Volumen Aliviado para L=25m

H	S	Q	N
0	0.00	0	0
1	1,730,781.10	55.368086	508.456572
2	3,542,973.65	156.604598	1062.461646
3	5,464,075.07	287.701017	1661.649140

Tabla 5: Volumen Aliviado para L=25m

b) Gráfico



Gráfico 2: N vs Q para L=25m

4.3.1.3.2. L=50

a) Cálculo

Cd =	0.75
L =	50.00

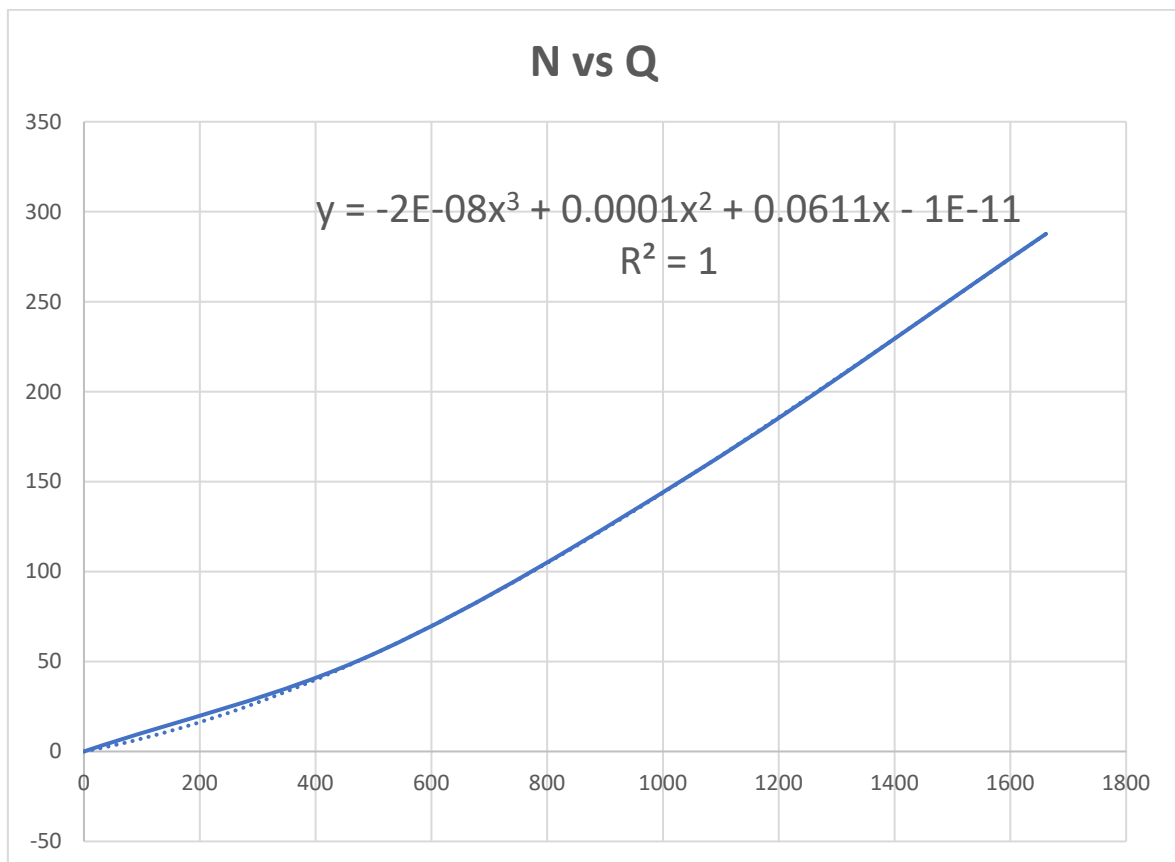
Tabla 6: Coeficiente para el Cálculo de Volumen Aliviado para L=50m

H	S	Q	N
0	0.00	0	0
1	1,730,781.10	110.736173	536.1406149
2	3,542,973.65	313.2091953	1140.763945
3	5,464,075.07	575.4020334	1805.499648

Tabla 7: Volumen Aliviado para L=50m

b) Gráfico



Gráfico 3: N vs Q para L=50m

4.3.1.3.3. L=75

a) Cálculo

Cd =	0.75
L =	75.00

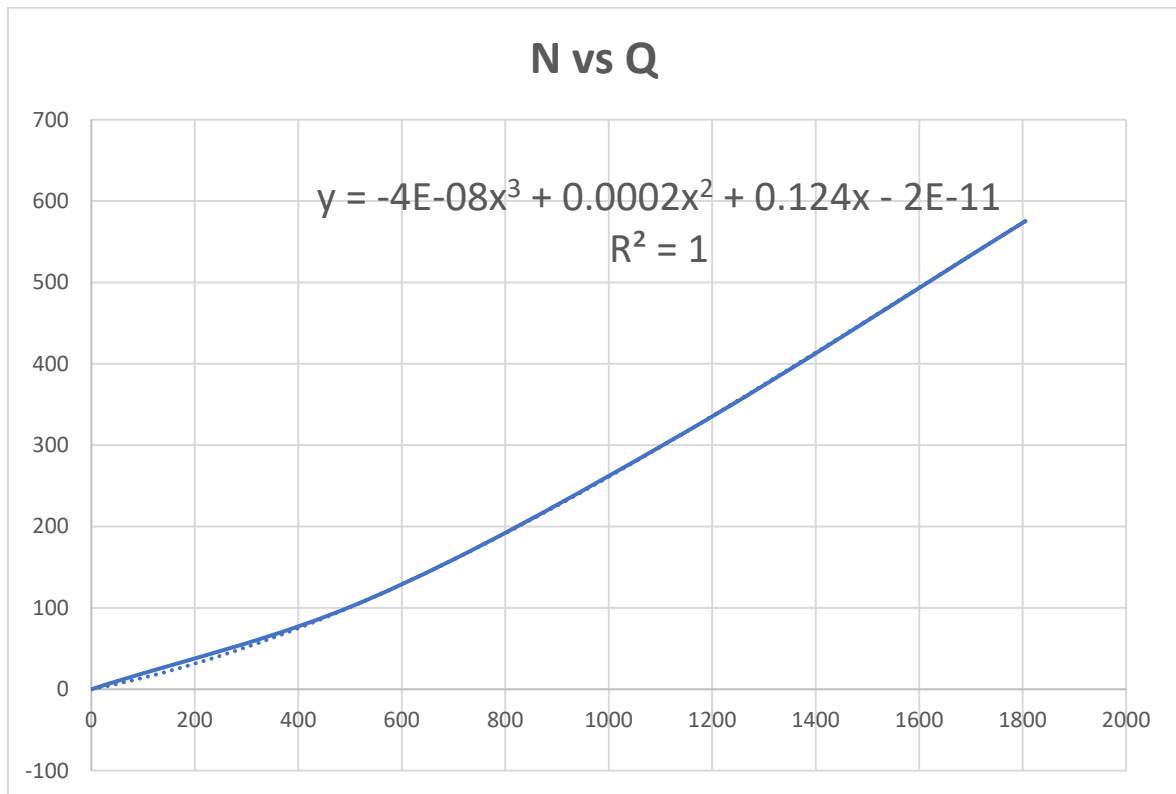
Tabla 8: Coeficiente para el Cálculo de Volumen Aliviado para L=75m

H	S	Q	N
0	0.00	0	0
1	1,730,781.10	166.1042594	563.8246582
2	3,542,973.65	469.8137929	1219.066244
3	5,464,075.07	863.10305	1949.350157

Tabla 9: Volumen Aliviado para L=75m

b) Gráfico



Gráfico 4: N vs Q para L=75m

4.3.1.3.4. L=100

a) Cálculo

Cd =	0.75
L =	100.00

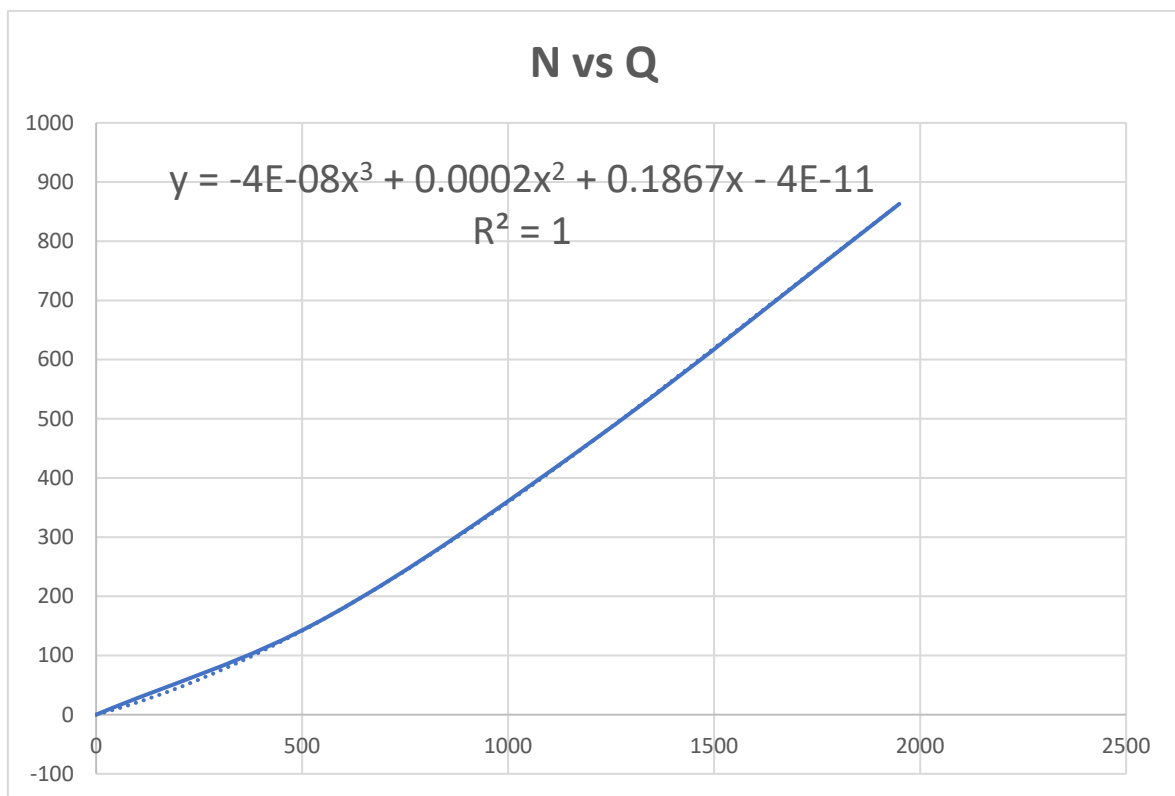
Tabla 10: Coeficiente para el Cálculo de Volumen Aliviado para L=100m

H	S	Q	N
0	0.00	0	0
1	1,730,781.10	221.4723459	591.5087014
2	3,542,973.65	626.4183905	1297.368543
3	5,464,075.07	1150.804067	2093.200665

Tabla 11: Volumen Aliviado para L=100m

b) Gráfico



Gráfico 5: N vs Q para L=100m

4.3.1.3.5. L=125

a) Cálculo

Cd =	0.75
L =	125.00

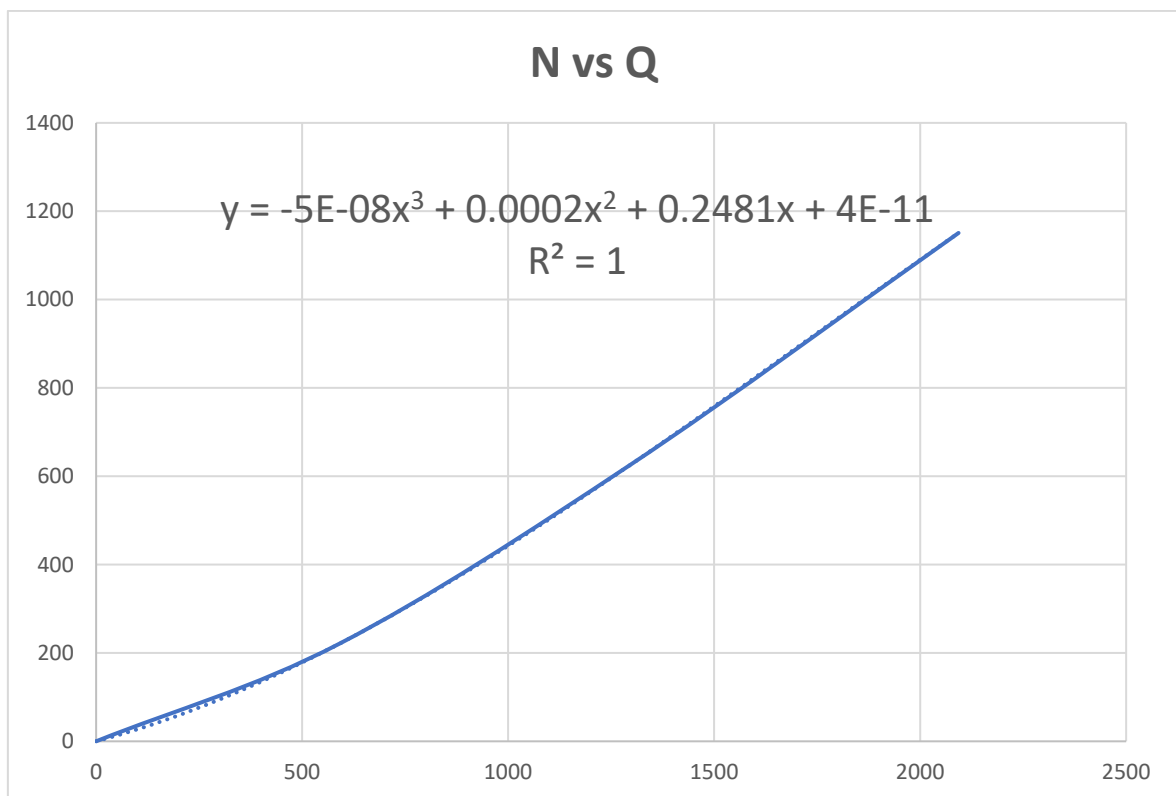
Tabla 12: Coeficiente para el Cálculo de Volumen Aliviado para L=125m

H	S	Q	N
0	0.00	0	0
1	1,730,781.10	276.8404324	619.1927446
2	3,542,973.65	783.0229882	1375.670841
3	5,464,075.07	1438.505083	2237.051174

Tabla 13: Volumen Aliviado para L=125m

b) Gráfico



Gráfico 6: N vs Q para L=125m

4.3.1.3.6. L=150

a) Cálculo

Cd =	0.75
L =	150.00

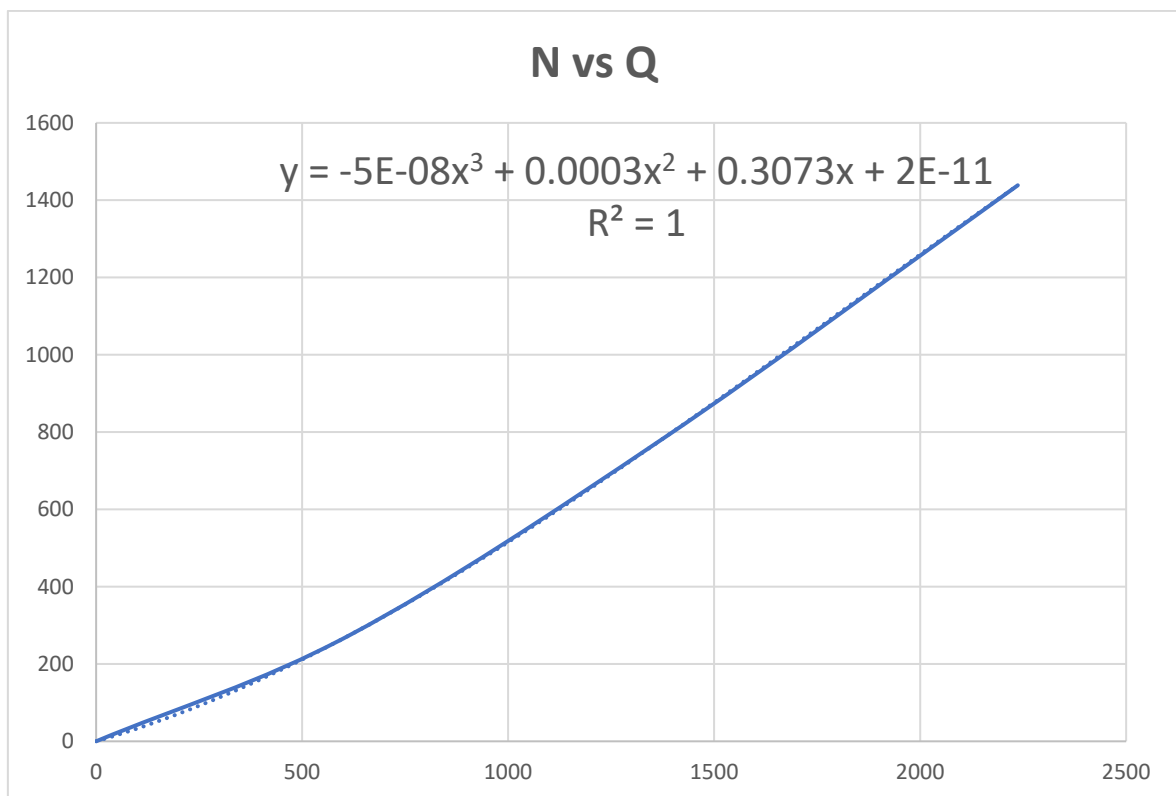
Tabla 14: Coeficiente para el Cálculo de Volumen Aliviado para L=150m

H	S	Q	N
0	0.00	0	0
1	1,730,781.10	332.2085189	646.8767879
2	3,542,973.65	939.6275858	1453.97314
3	5,464,075.07	1726.2061	2380.901682

Tabla 15: Volumen Aliviado para L=150m

b) Gráfico



Gráfico 7: N vs Q para L=150m

4.3.1.3.7. L=175

a) Cálculo

Cd =	0.75
L =	175.00

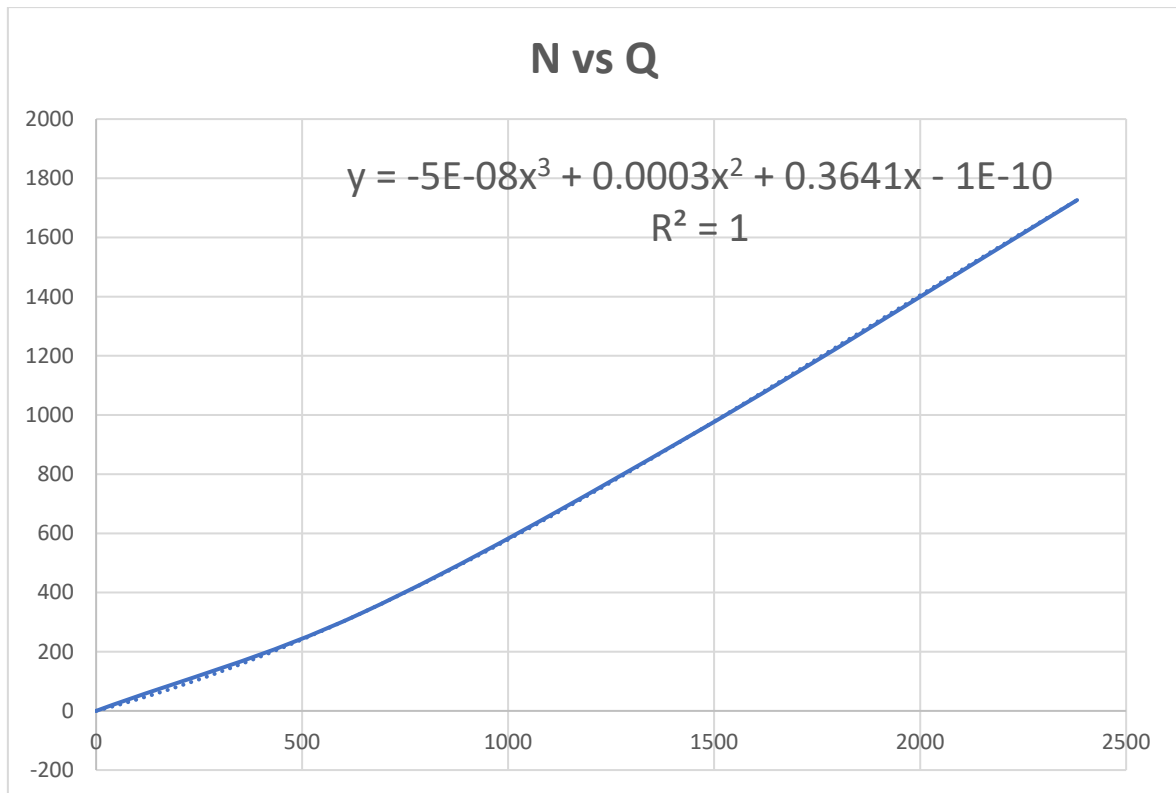
Tabla 16: Coeficiente para el Cálculo de Volumen Aliviado para L=175m

H	S	Q	N
0	0.00	0	0
1	1,730,781.10	387.5766053	674.5608311
2	3,542,973.65	1096.232183	1532.275439
3	5,464,075.07	2013.907117	2524.75219

Tabla 17: Volumen Aliviado para L=175m

b) Gráfico



Gráfico 8: N vs Q para L=175m

4.3.1.3.8. L=200

a) Cálculo

Cd =	0.75
L =	200.00

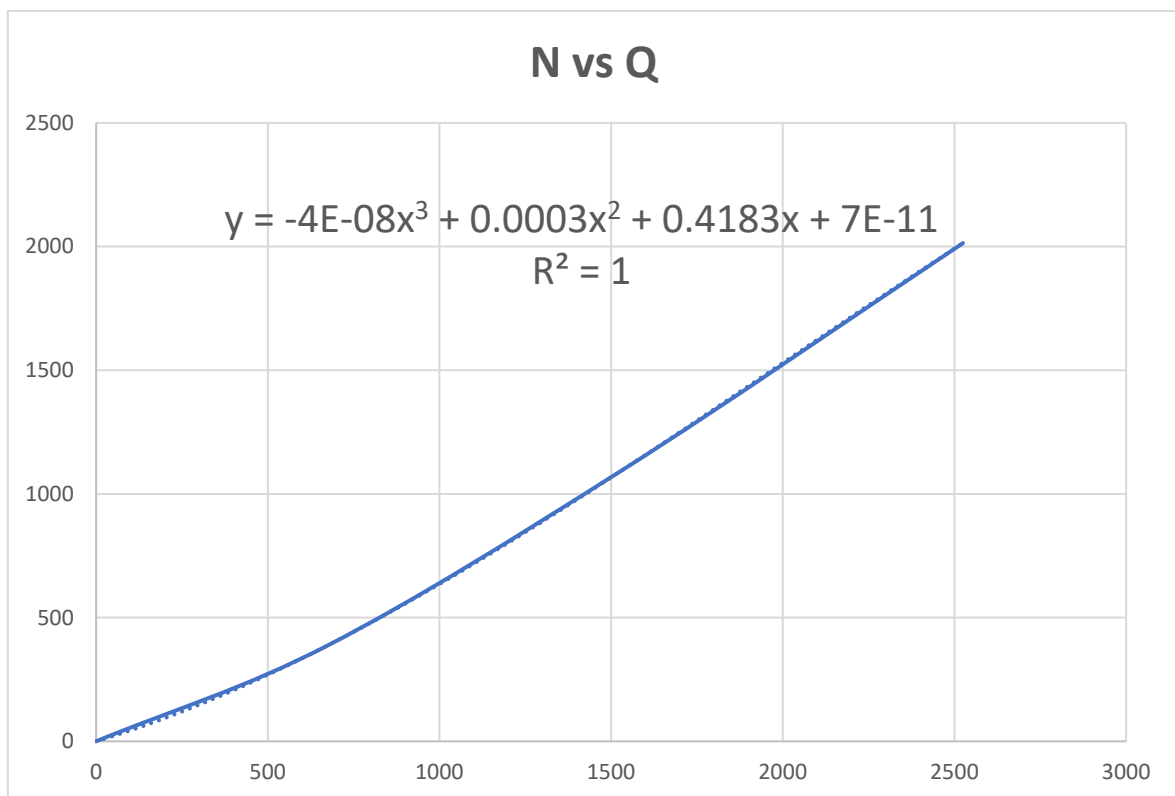
Tabla 18: Coeficiente para el Cálculo de Volumen Aliviado para L=200m

H	S	Q	N
0	0.00	0	0
1	1,730,781.10	442.9446918	702.2448743
2	3,542,973.65	1252.836781	1610.577738
3	5,464,075.07	2301.608133	2668.602699

Tabla 19: Volumen Aliviado para L=200m

b) Gráfico



Gráfico 9: N vs Q para L=200m

4.3.1.3.9. L=225

a) Cálculo

Cd =	0.75
L =	225.00

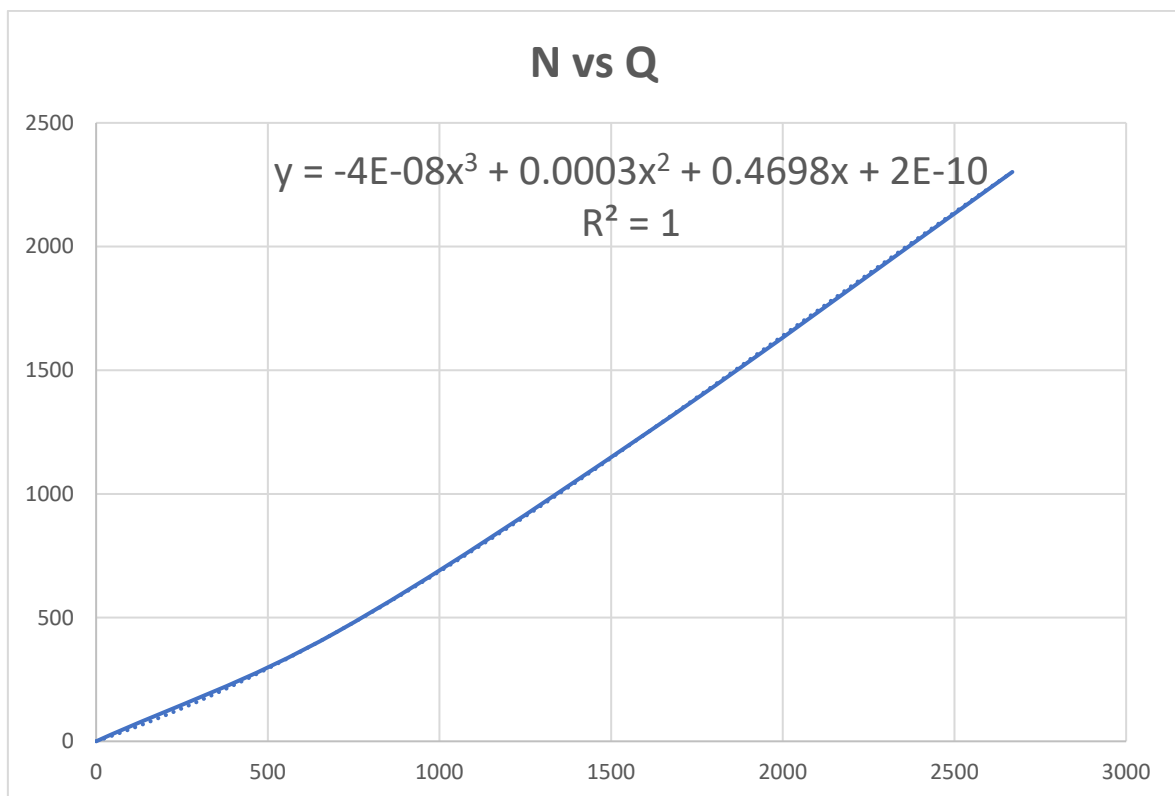
Tabla 20: Coeficiente para el Cálculo de Volumen Aliviado para L=225m

H	S	Q	N
0	0.00	0	0
1	1,730,781.10	498.3127783	729.9289176
2	3,542,973.65	1409.441379	1688.880037
3	5,464,075.07	2589.30915	2812.453207

Tabla 21: Volumen Aliviado para L=225m

b) Gráfico



Gráfico 10: N vs Q para L=225m

4.3.1.3.10. L=250

a) Cálculo

Cd =	0.75
L =	250.00

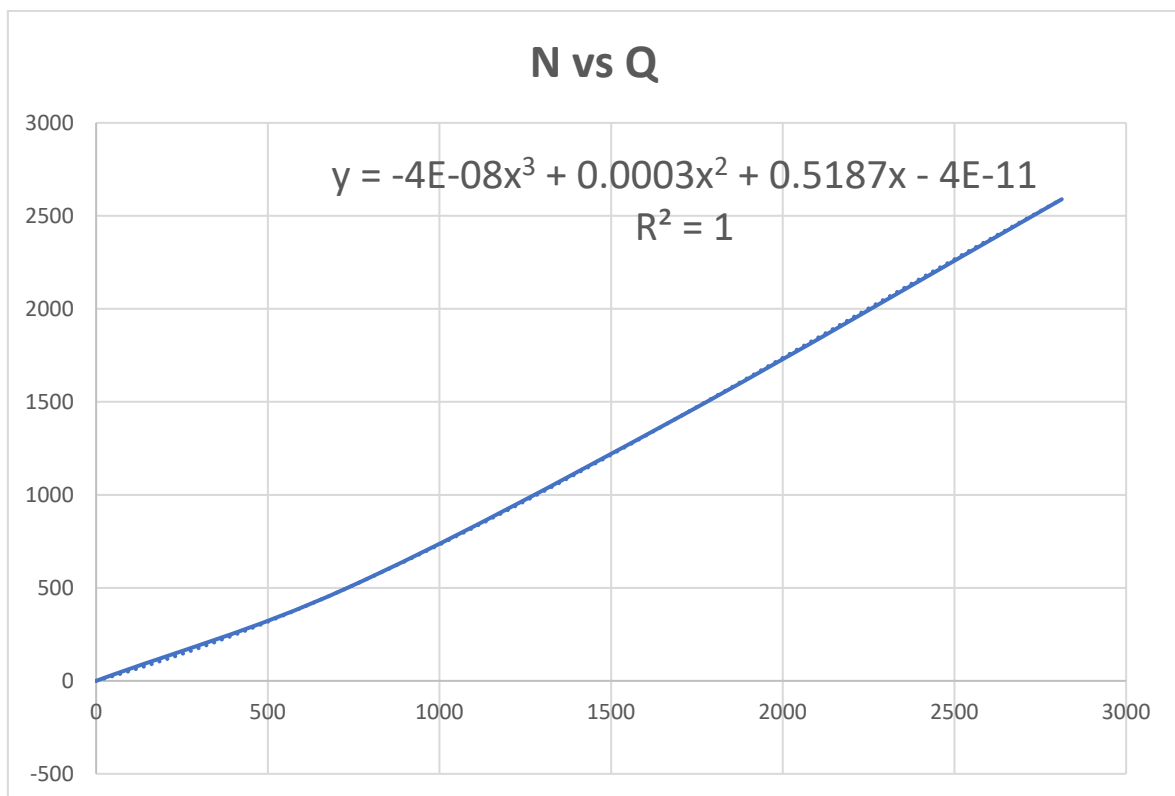
Tabla 22: Coeficiente para el Cálculo de Volumen Aliviado para L=250m

H	S	Q	N
0	0.00	0	0
1	1,730,781.10	553.6808648	757.6129608
2	3,542,973.65	1566.045976	1767.182336
3	5,464,075.07	2877.010167	2956.303715

Tabla 23: Volumen Aliviado para L=250m

b) Gráfico



Gráfico 11: N vs Q para L=250m

4.3.1.3.11. L=275

a) Cálculo

Cd =	0.75
L =	275.00

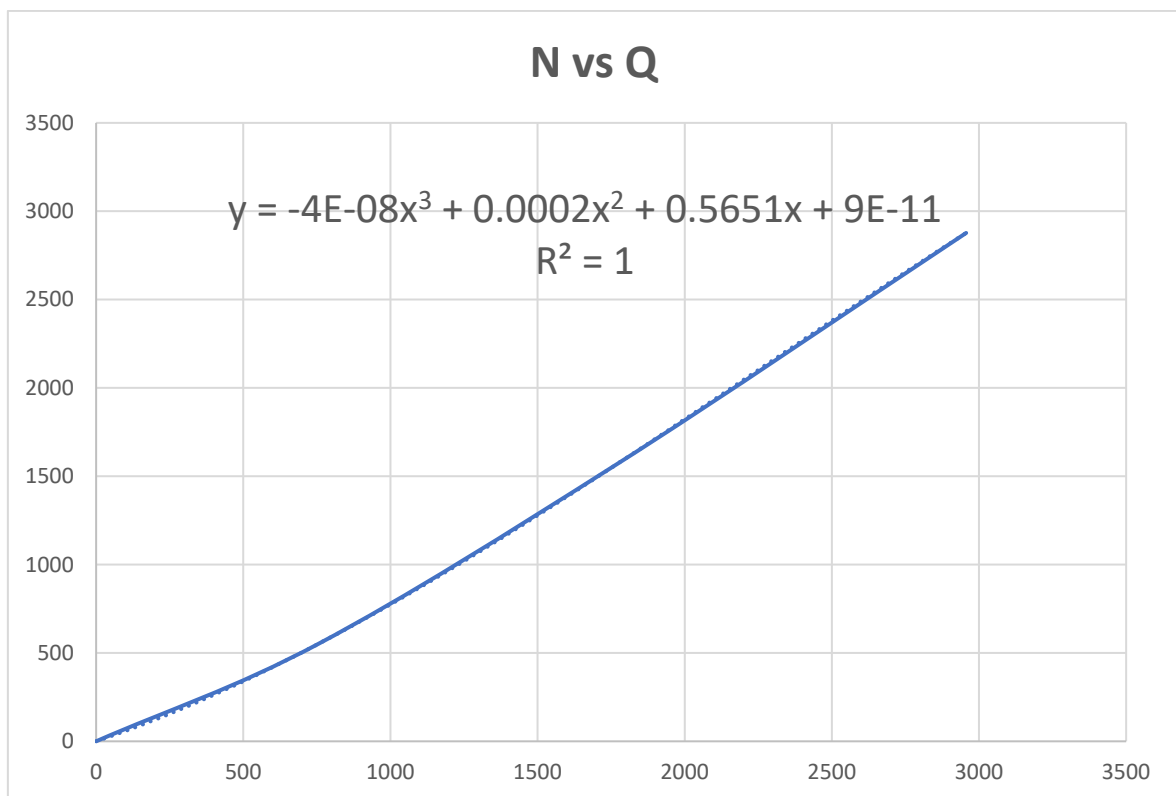
Tabla 24: Coeficiente para el Cálculo de Volumen Aliviado para L=275m

H	S	Q	N
0	0.00	0	0
1	1,730,781.10	609.0489512	785.2970041
2	3,542,973.65	1722.650574	1845.484634
3	5,464,075.07	3164.711184	3100.154224

Tabla 25: Volumen Aliviado para L=275m

b) Gráfico



Gráfico 12: N vs Q para L=275m

4.3.1.3.12. L=300

a) Cálculo

Cd =	0.75
L =	300.00

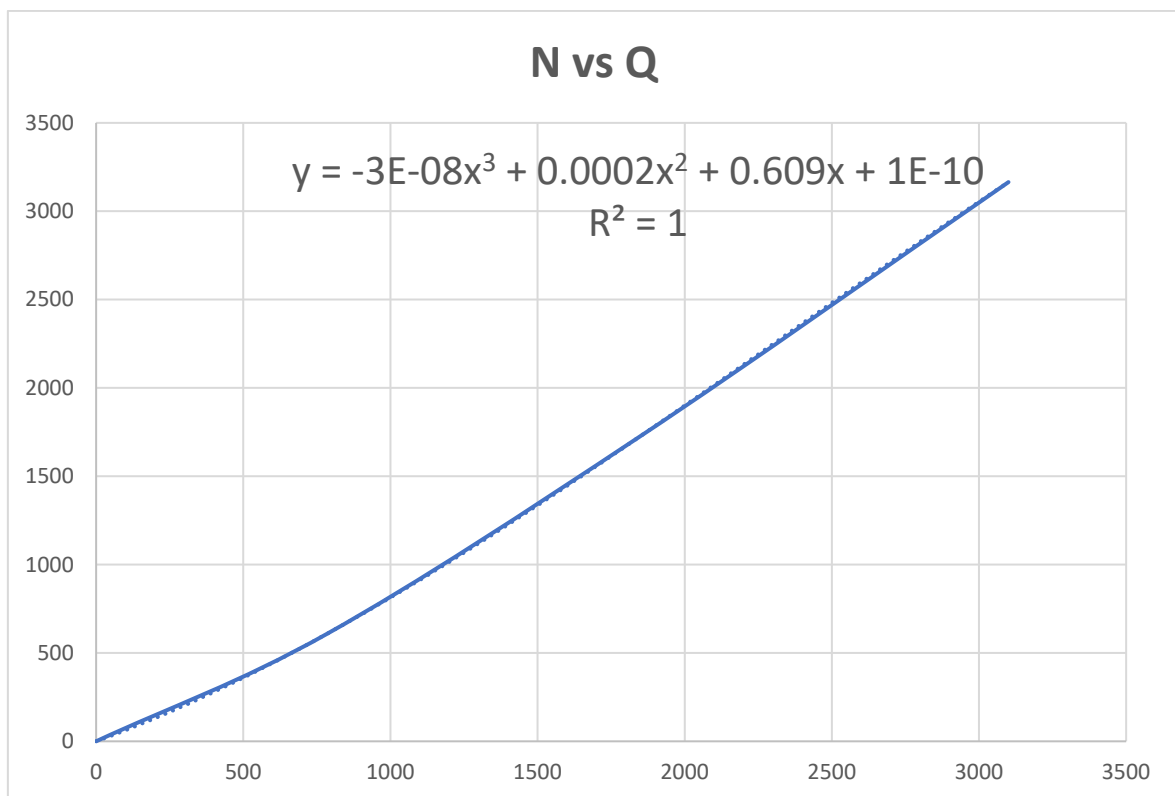
Tabla 26: Coeficiente para el Cálculo de Volumen Aliviado para L=300m

H	S	Q	N
0	0.00	0	0
1	1,730,781.10	664.4170377	812.9810473
2	3,542,973.65	1879.255172	1923.786933
3	5,464,075.07	3452.4122	3244.004732

Tabla 27: Volumen Aliviado para L=300m

b) Gráfico



Gráfico 13: N vs Q para L=300m

4.3.1.3.13. L=325

a) Cálculo

Cd =	0.75
L =	325.00

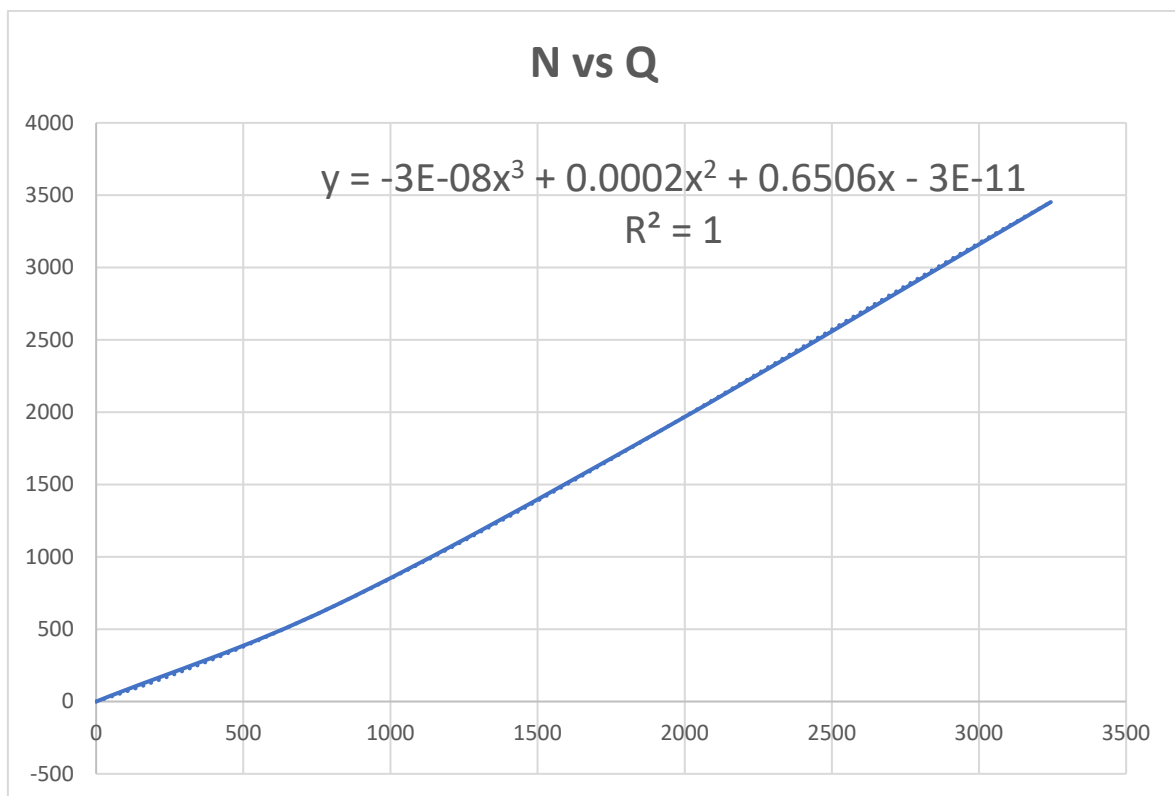
Tabla 28: Coeficiente para el Cálculo de Volumen Aliviado para L=325m

H	S	Q	N
0	0.00	0	0
1	1,730,781.10	719.7851242	840.6650905
2	3,542,973.65	2035.859769	2002.089232
3	5,464,075.07	3740.113217	3387.85524

Tabla 29: Volumen Aliviado para L=325m

b) Gráfico



Gráfico 14: N vs Q para L=325m

4.3.1.3.14. L=350

a) Cálculo

Cd =	0.75
L =	350.00

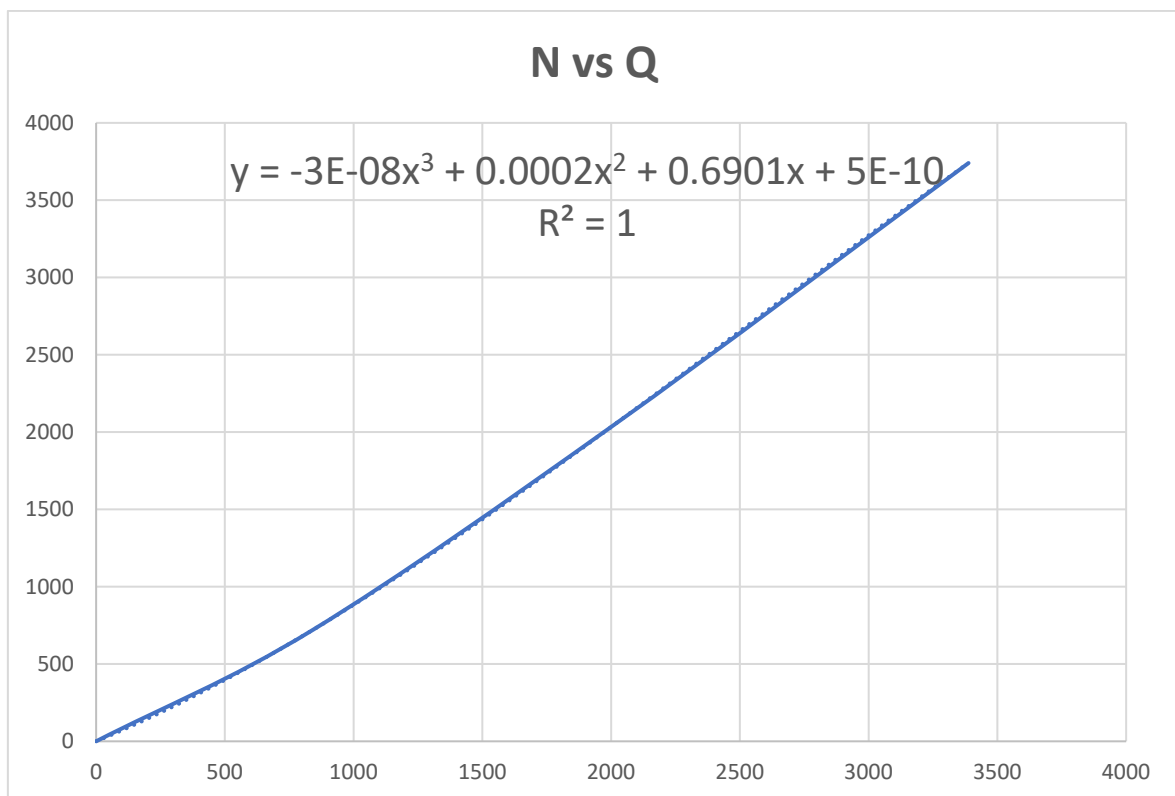
Tabla 30: Coeficiente para el Cálculo de Volumen Aliviado para L=350m

H	S	Q	N
0	0.00	0	0
1	1,730,781.10	775.1532107	868.3491338
2	3,542,973.65	2192.464367	2080.391531
3	5,464,075.07	4027.814234	3531.705749

Tabla 31: Volumen Aliviado para L=350m

b) Gráfico



Gráfico 15: N vs Q para L=350m

4.3.2. Embalse 2

4.3.2.1. Cálculos

ALTURA (m)	COTA (msnm)	AREA PARCIAL (m2)	AREA ACUMULADA (m2)	AREA MEDIA (m2)	VOLUMEN (m3)	VOLUMEN ACUMULADO (m3)	VOLUMEN ACUMULADO (MMC)
0	665	0.00	0.00	0.00	0.00	0.00	0.00
1	666	8,084.69	8,084.69	4,042.35	4,042.35	4,042.35	0.00
2	667	12,324.29	20,408.99	14,246.84	14,246.84	18,289.18	0.02
3	668	14,340.35	34,749.34	27,579.16	27,579.16	45,868.35	0.05
4	669	22,456.52	57,205.86	45,977.60	45,977.60	91,845.95	0.09
5	670	40,014.80	97,220.66	77,213.26	77,213.26	169,059.21	0.17
6	671	35,951.64	133,172.30	115,196.48	115,196.48	284,255.69	0.28
7	672	23,151.48	156,323.78	144,748.04	144,748.04	429,003.73	0.43
8	673	26,682.33	183,006.12	169,664.95	169,664.95	598,668.68	0.60
9	674	23,464.25	206,470.37	194,738.24	194,738.24	793,406.93	0.79
10	675	22,767.66	229,238.03	217,854.20	217,854.20	1,011,261.13	1.01
11	676	18,908.13	248,146.16	238,692.10	238,692.10	1,249,953.22	1.25
12	677	14,564.41	262,710.57	255,428.36	255,428.36	1,505,381.59	1.51
13	678	13,546.50	276,257.07	269,483.82	269,483.82	1,774,865.41	1.77
14	679	12,938.23	289,195.29	282,726.18	282,726.18	2,057,591.58	2.06
15	680	12,020.52	301,215.82	295,205.55	295,205.55	2,352,797.14	2.35
16	681	18,607.51	319,823.33	310,519.57	310,519.57	2,663,316.71	2.66
17	682	24,969.81	344,793.14	332,308.23	332,308.23	2,995,624.94	3.00
18	683	21,683.62	366,476.76	355,634.95	355,634.95	3,351,259.89	3.35
19	684	17,192.18	383,668.94	375,072.85	375,072.85	3,726,332.74	3.73
20	685	17,983.66	401,652.60	392,660.77	392,660.77	4,118,993.51	4.12
21	686	22,046.37	423,698.97	412,675.78	412,675.78	4,531,669.29	4.53
22	687	23,378.51	447,077.48	435,388.22	435,388.22	4,967,057.52	4.97
23	688	33,364.31	480,441.79	463,759.63	463,759.63	5,430,817.15	5.43
24	689	35,445.47	515,887.26	498,164.53	498,164.53	5,928,981.68	5.93
25	690	53,605.36	569,492.62	542,689.94	542,689.94	6,471,671.62	6.47
26	691	48,747.93	618,240.55	593,866.59	593,866.59	7,065,538.21	7.07
27	692	44,858.17	663,098.72	640,669.64	640,669.64	7,706,207.85	7.71
28	693	58,082.15	721,180.88	692,139.80	692,139.80	8,398,347.65	8.40
29	694	51,833.08	773,013.96	747,097.42	747,097.42	9,145,445.06	9.15
30	695	41,523.35	814,537.31	793,775.63	793,775.63	9,939,220.69	9.94
31	696	43,614.13	858,151.44	836,344.37	836,344.37	10,775,565.07	10.78
32	697	44,280.08	902,431.52	880,291.48	880,291.48	11,655,856.54	11.66
33	698	56,223.16	958,654.67	930,543.10	930,543.10	12,586,399.64	12.59
34	699	59,035.25	1,017,689.93	988,172.30	988,172.30	13,574,571.94	13.57
35	700	48,955.73	1,066,645.66	1,042,167.80	1,042,167.80	14,616,739.74	14.62
36	701	65,587.69	1,132,233.36	1,099,439.51	1,099,439.51	15,716,179.25	15.72
37	702	61,693.89	1,193,927.24	1,163,080.30	1,163,080.30	16,879,259.55	16.88

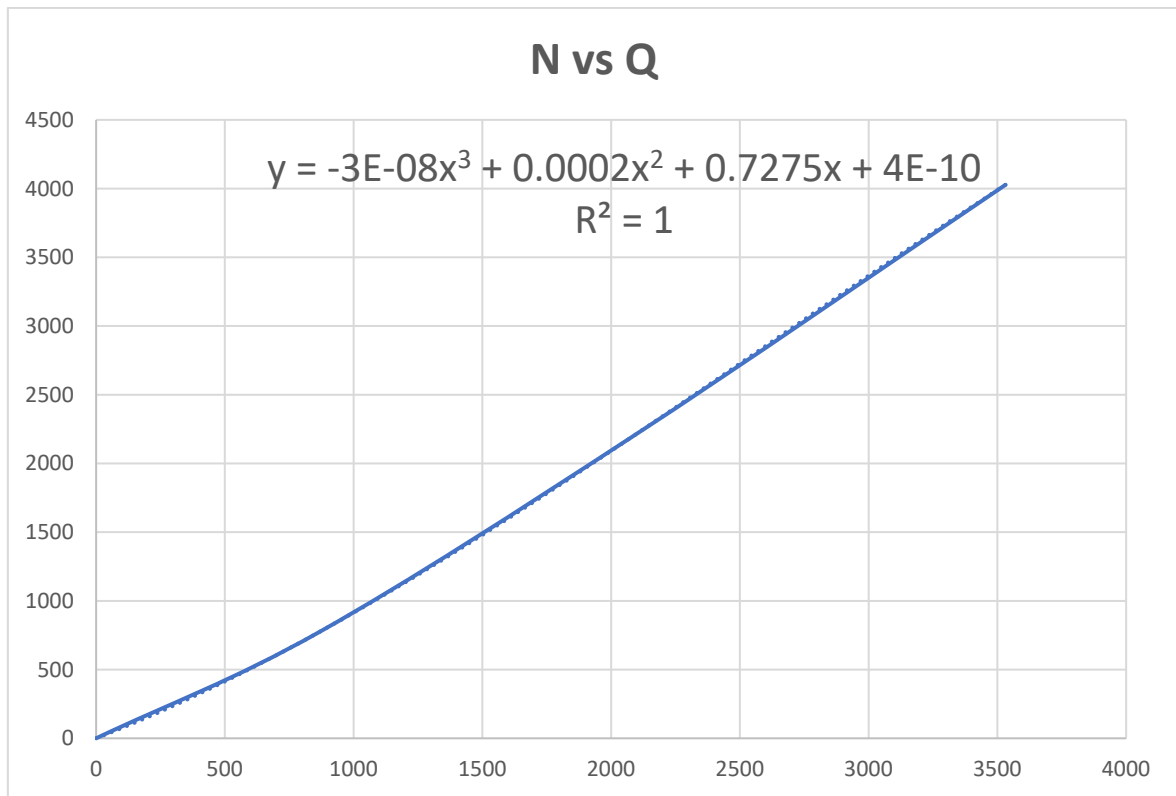
Tabla 32: Cálculos de Volumen Acumulado del Embalse 2

4.3.2.2. Gráfico Curva Cota-Área-Volumen



Gráfico 16: Curva Cota - Área - Volumen del Embalse 2

4.3.2.3. N vs Q

$$Q = \frac{2}{3} \sqrt{2g} \cdot Cd \cdot L \cdot H^{3/2} \quad N = \frac{Q}{2} + \frac{S}{\Delta t}$$

4.3.2.3.1. L=25

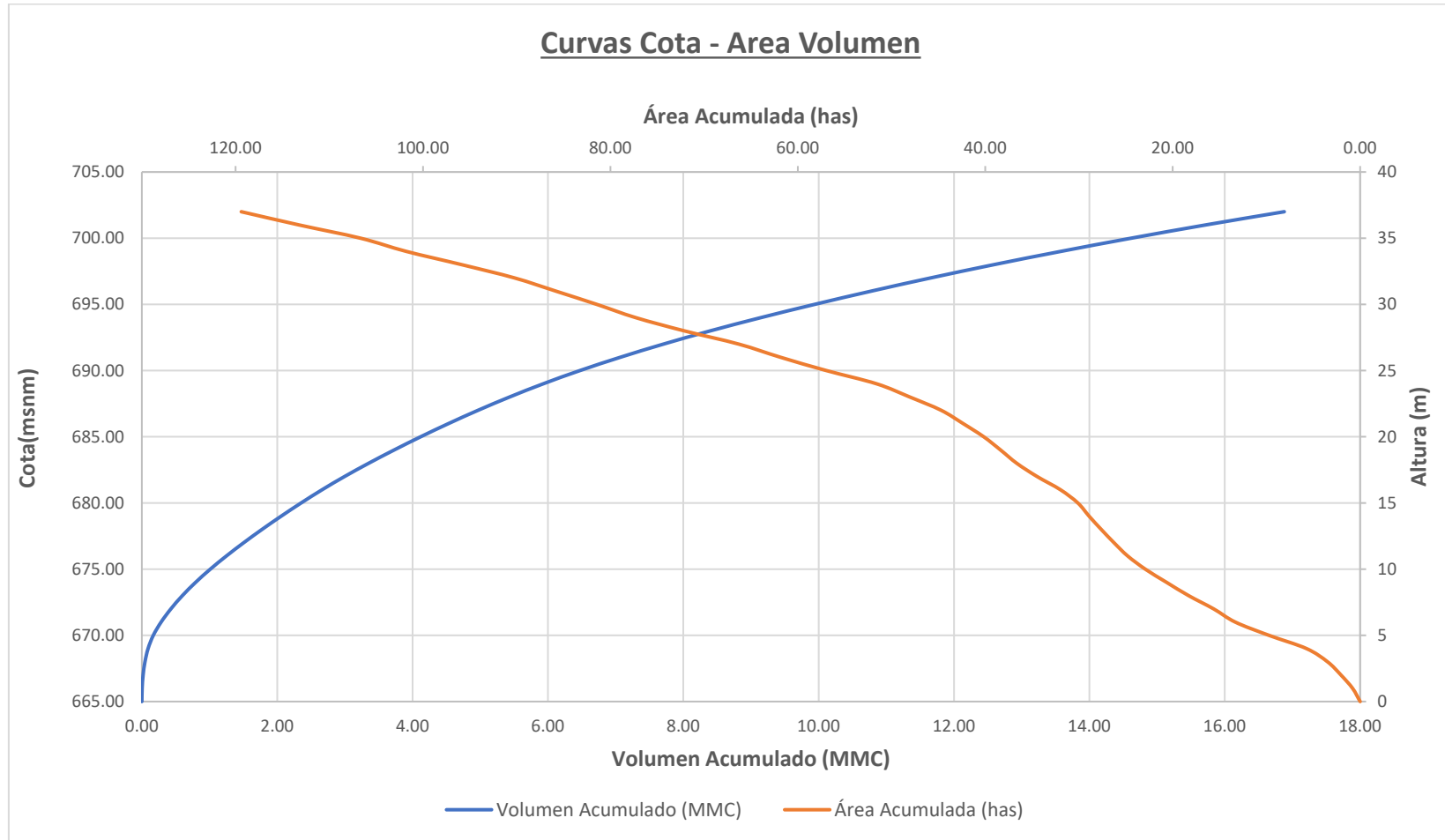
a) Cálculo

Cd =	0.75
L =	25.00

Tabla 33: Coeficiente para el Cálculo de Volumen Aliviado para L=25m

H	S	Q	N
0	0.00	0	0
1	1,042,167.80	55.36808648	317.1750976
2	2,141,607.31	156.6045976	673.1932172
3	3,304,687.61	287.7010167	1061.819288

Tabla 34: Volumen Aliviado para L=25m

b) Gráfico



Gráfico 17: N vs Q para L=25m

4.3.2.3.2. L=50

a) Cálculo

Cd =	0.75
L =	50.00

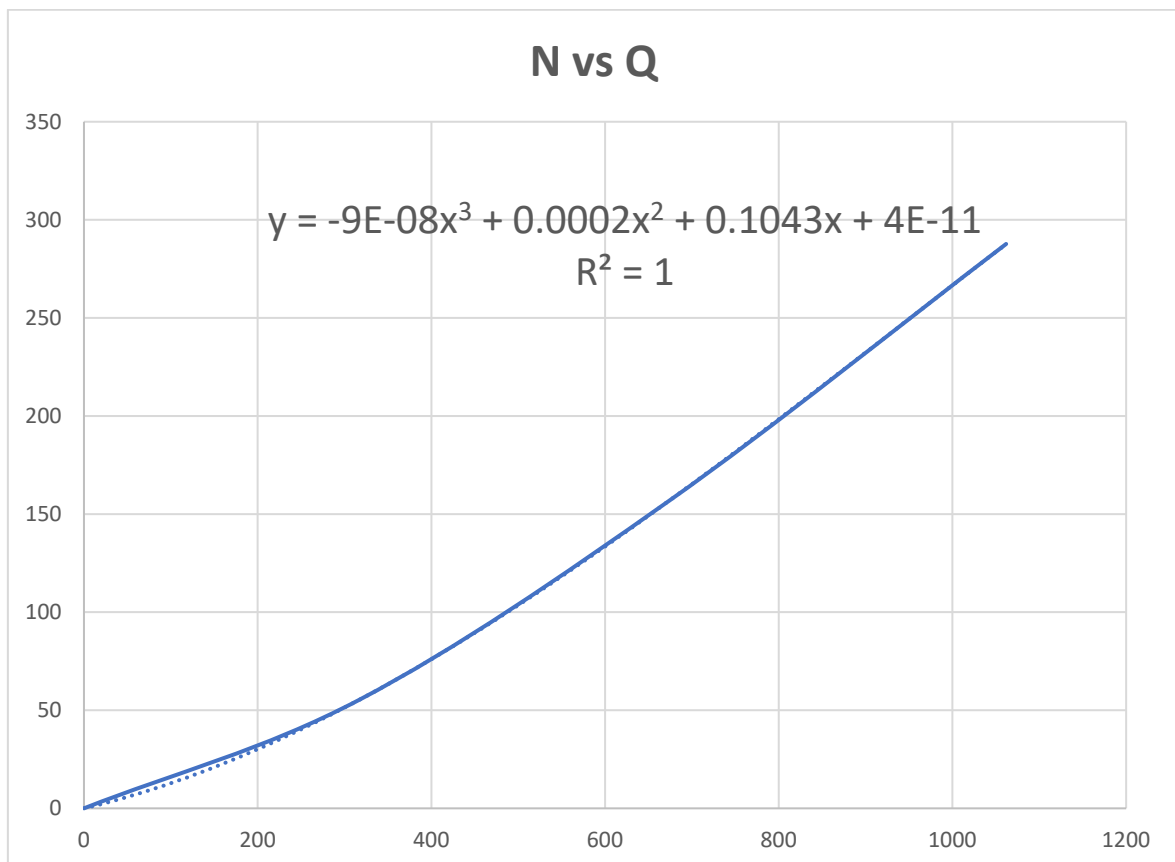
Tabla 35: Coeficiente para el Cálculo de Volumen Aliviado para L=50m

H	S	Q	N
0	0.00	0	0
1	1,042,167.80	110.736173	344.8591409
2	2,141,607.31	313.2091953	751.495516
3	3,304,687.61	575.4020334	1205.669796

Tabla 36: Volumen Aliviado para L=50m

b) Gráfico



Gráfico 18: N vs Q para L=50m

4.3.2.3.3. L=75

a) Cálculo

Cd =	0.75
L =	75.00

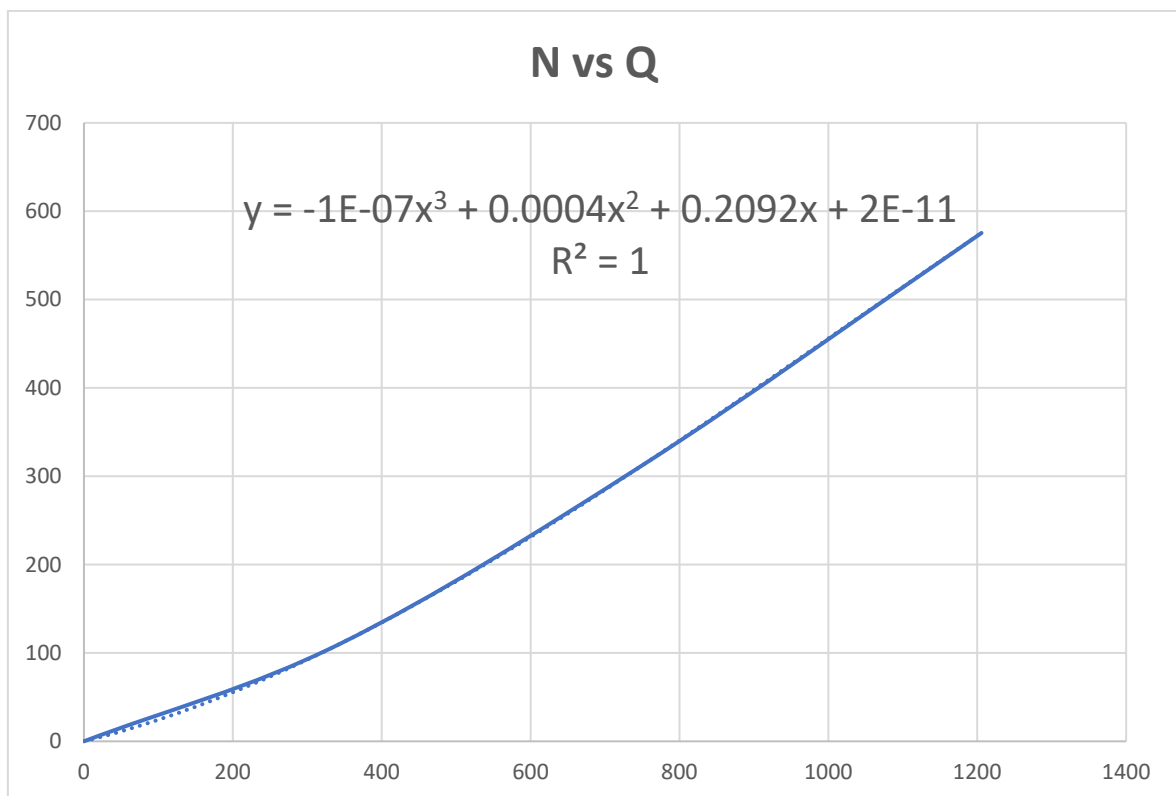
Tabla 37: Coeficiente para el Cálculo de Volumen Aliviado para L=75m

H	S	Q	N
0	0.00	0	0
1	1,042,167.80	166.1042594	372.5431841
2	2,141,607.31	469.8137929	829.7978148
3	3,304,687.61	863.10305	1349.520305

Tabla 38: Volumen Aliviado para L=75m

b) Gráfico



Gráfico 19: N vs Q para L=75m

4.3.2.3.4. L=100

a) Cálculo

Cd =	0.75
L =	100.00

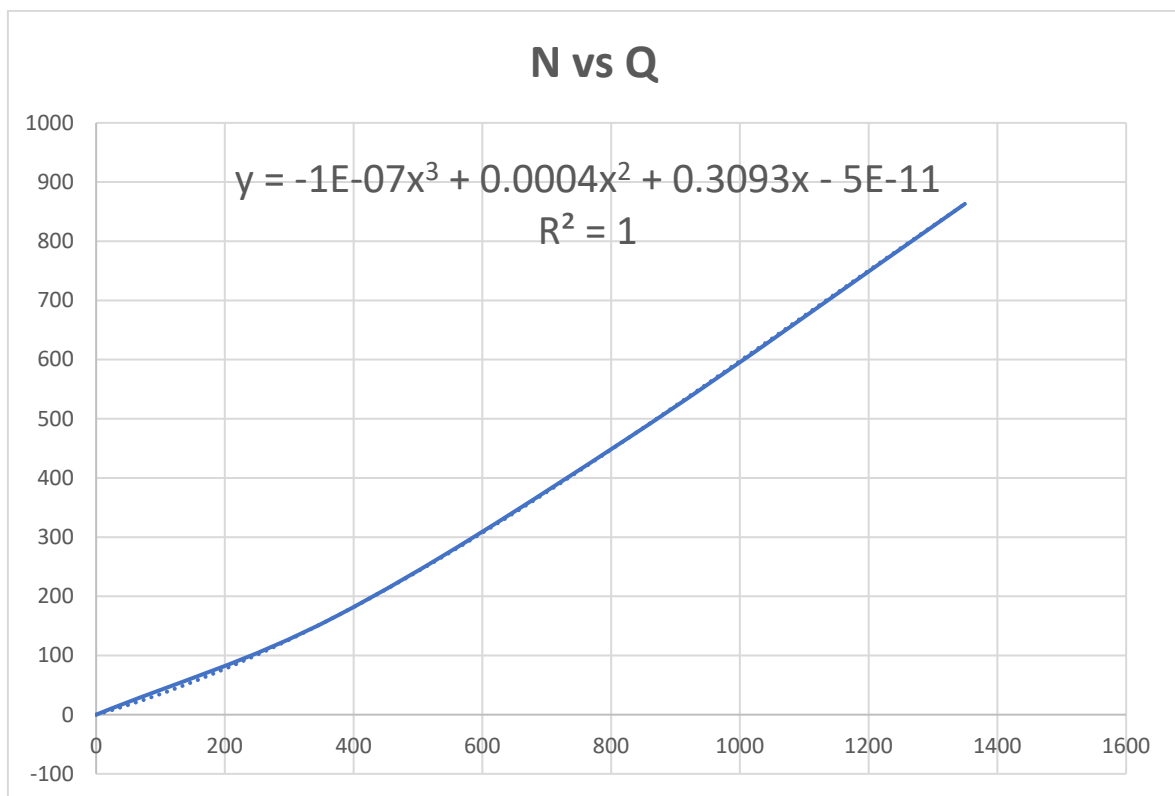
Tabla 39: Coeficiente para el Cálculo de Volumen Aliviado para L=100m

H	S	Q	N
0	0.00	0	0
1	1,042,167.80	221.4723459	400.2272273
2	2,141,607.31	626.4183905	908.1001136
3	3,304,687.61	1150.804067	1493.370813

Tabla 40: Volumen Aliviado para L=100m

b) Gráfico



Gráfico 20: N vs Q para L=100m

4.3.2.3.5. L=125

a) Cálculo

Cd =	0.75
L =	125.00

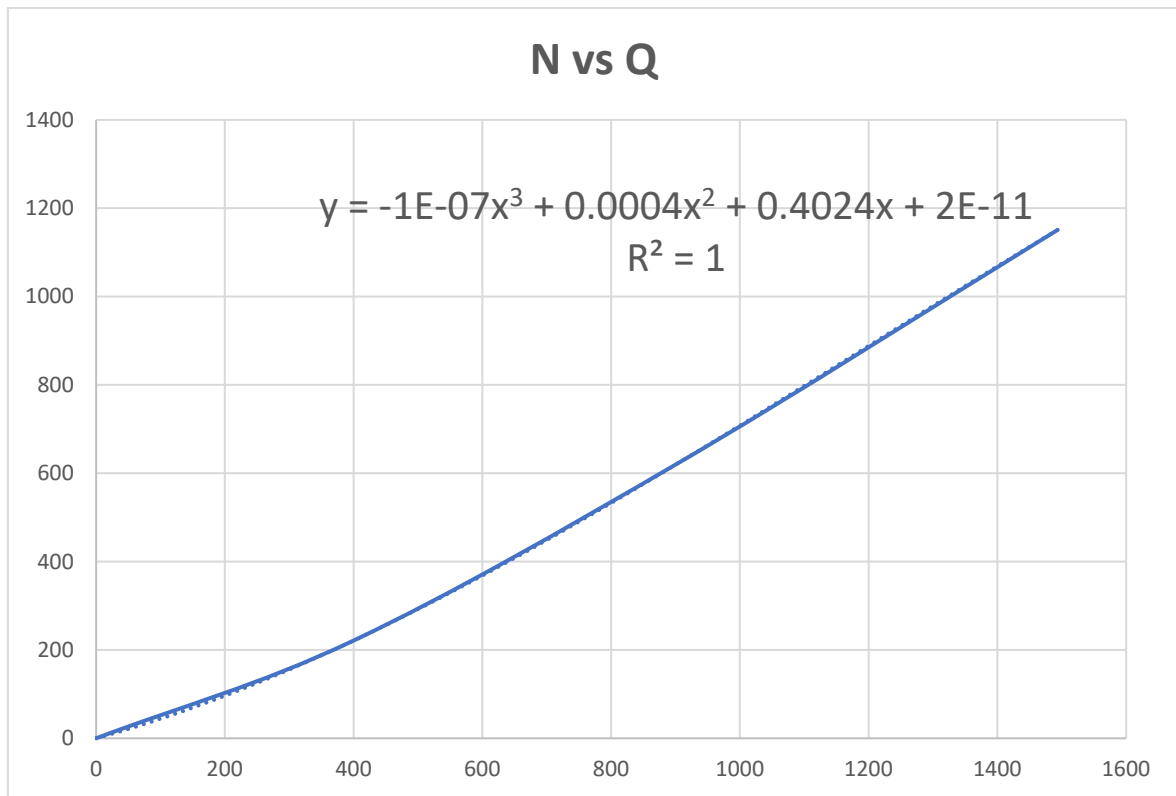
Tabla 41: Coeficiente para el Cálculo de Volumen Aliviado para L=125m

H	S	Q	N
0	0.00	0	0
1	1,042,167.80	276.8404324	427.9112706
2	2,141,607.31	783.0229882	986.4024124
3	3,304,687.61	1438.505083	1637.221321

Tabla 42: Volumen Aliviado para L=125m

b) Gráfico



Gráfico 21: N vs Q para L=125m

4.3.2.3.6. L=150

a) Cálculo

Cd =	0.75
L =	150.00

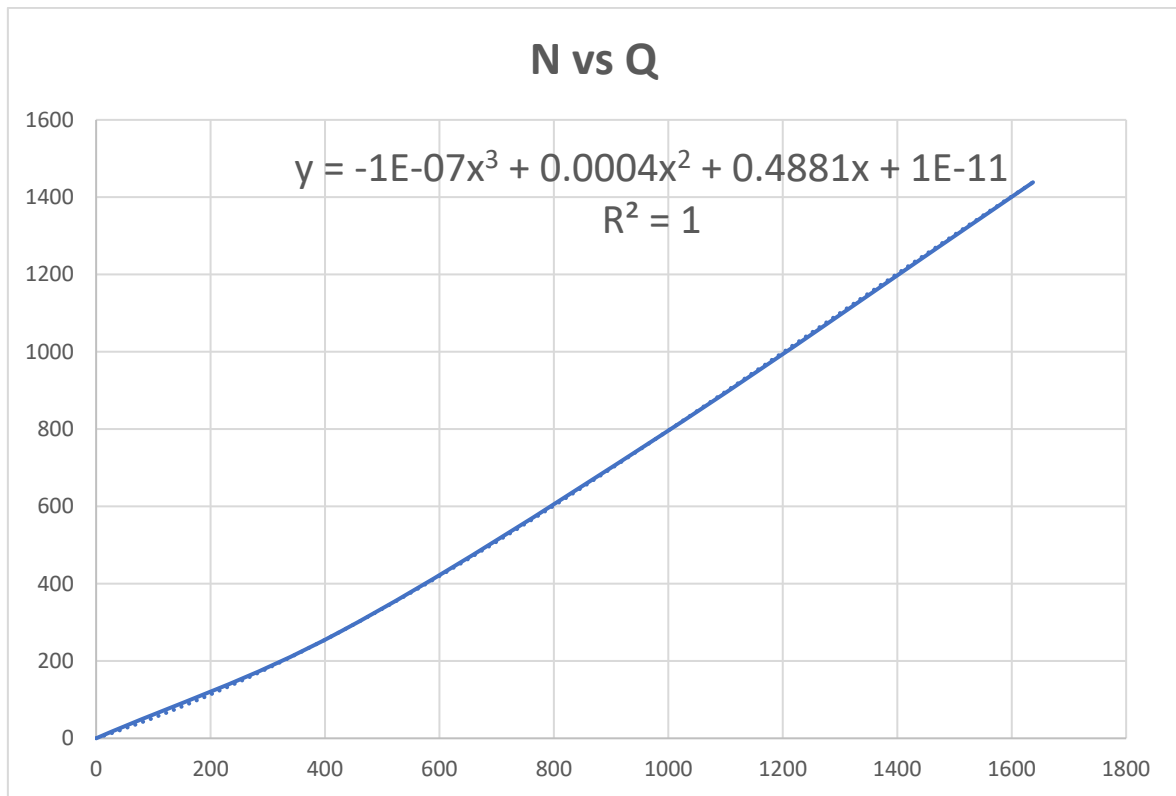
Tabla 43: Coeficiente para el Cálculo de Volumen Aliviado para L=150m

H	S	Q	N
0	0.00	0	0
1	1,042,167.80	332.2085189	455.5953138
2	2,141,607.31	939.6275858	1064.704711
3	3,304,687.61	1726.2061	1781.07183

Tabla 44: Volumen Aliviado para L=150m

b) Gráfico



Gráfico 22: N vs Q para L=150m

4.3.2.3.7. L=175

a) Cálculo

Cd =	0.75
L =	175.00

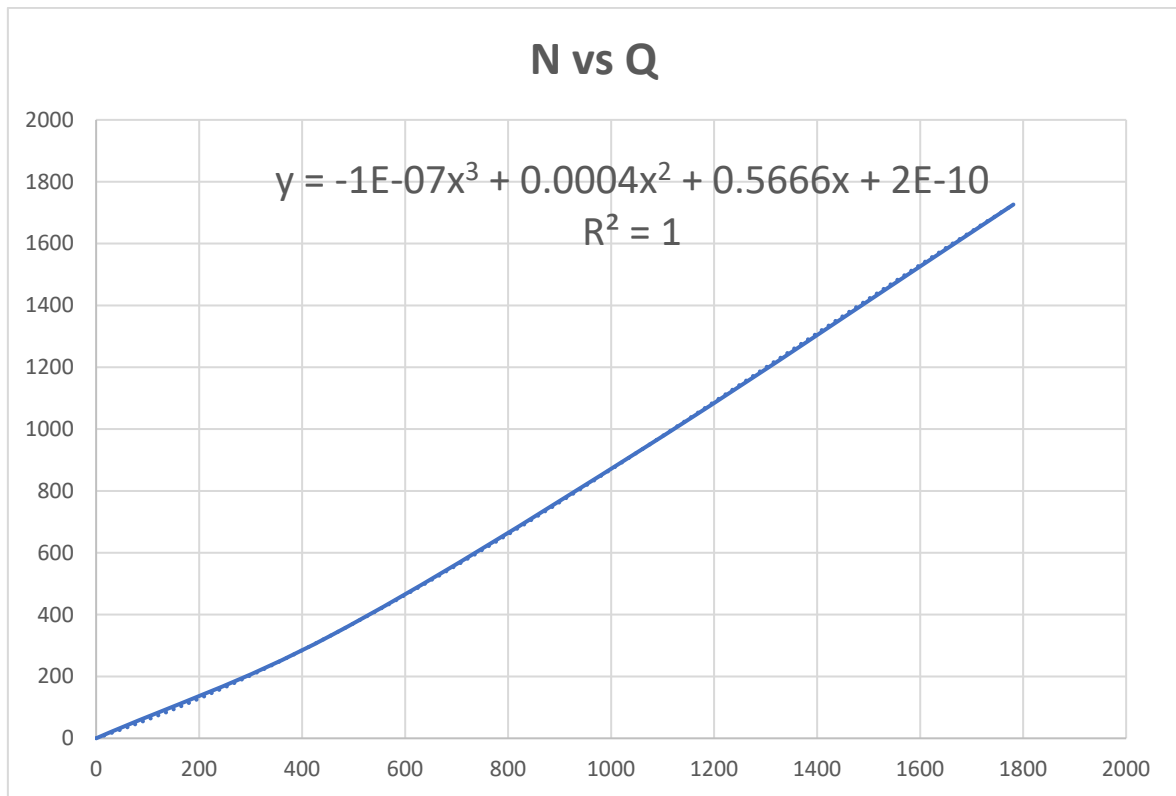
Tabla 45: Coeficiente para el Cálculo de Volumen Aliviado para L=175m

H	S	Q	N
0	0.00	0	0
1	1,042,167.80	387.5766053	483.2793571
2	2,141,607.31	1096.232183	1143.00701
3	3,304,687.61	2013.907117	1924.922338

Tabla 46: Volumen Aliviado para L=175m

b) Gráfico



Gráfico 23: N vs Q para L=175m

4.3.2.3.8. L=200

a) Cálculo

Cd =	0.75
L =	200.00

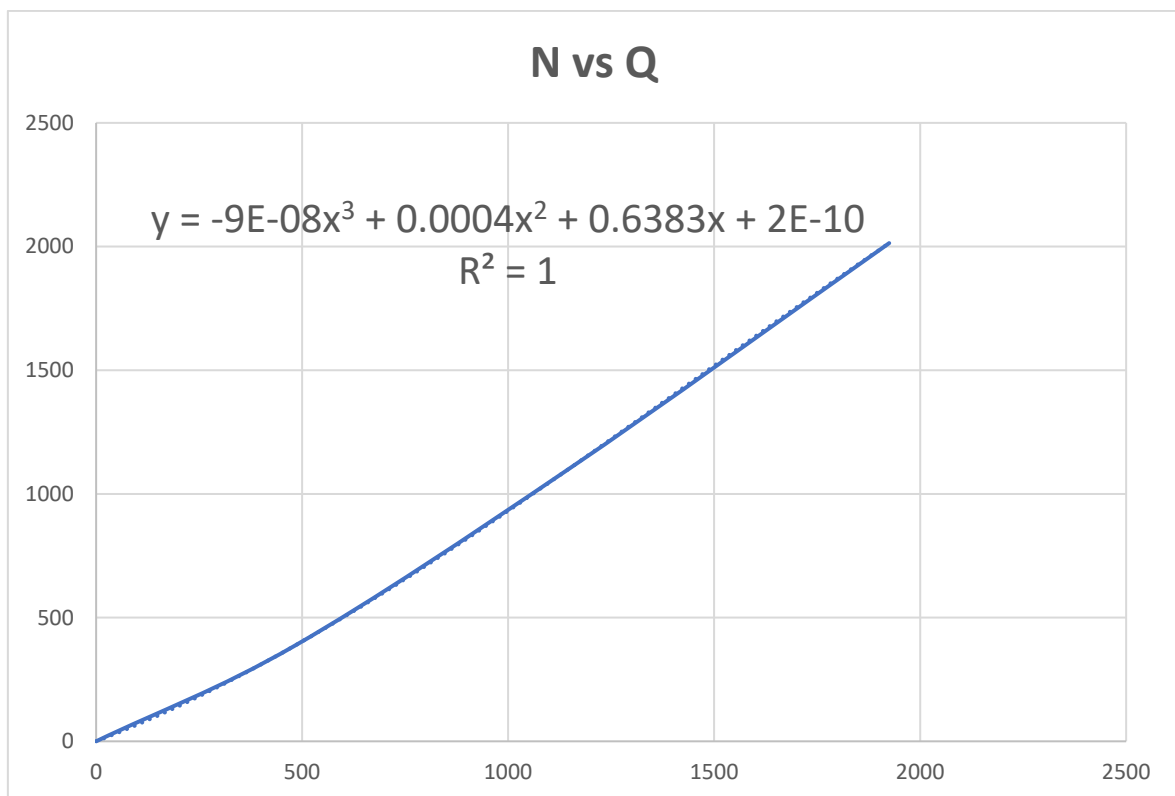
Tabla 47: Coeficiente para el Cálculo de Volumen Aliviado para L=200m

H	S	Q	N
0	0.00	0	0
1	1,042,167.80	442.9446918	510.9634003
2	2,141,607.31	1252.836781	1221.309309
3	3,304,687.61	2301.608133	2068.772846

Tabla 48: Volumen Aliviado para L=200m

b) Gráfico



Gráfico 24: N vs Q para L=200m

4.3.2.3.9. L=225

a) Cálculo

Cd =	0.75
L =	225.00

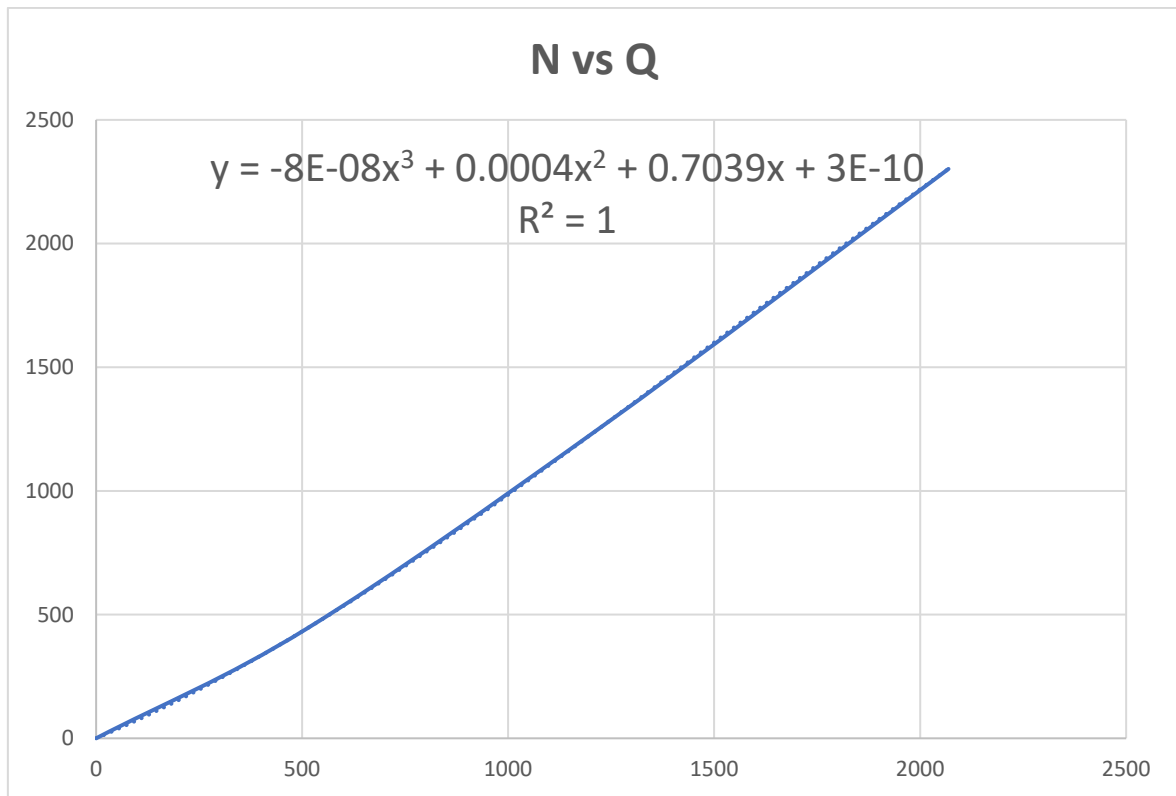
Tabla 49: Coeficiente para el Cálculo de Volumen Aliviado para L=225m

H	S	Q	N
0	0.00	0	0
1	1,042,167.80	498.3127783	538.6474435
2	2,141,607.31	1409.441379	1299.611608
3	3,304,687.61	2589.30915	2212.623355

Tabla 50: Volumen Aliviado para L=225m

b) Gráfico



Gráfico 25: N vs Q para L=225m

4.3.2.3.10. L=250

a) Cálculo

Cd =	0.75
L =	250.00

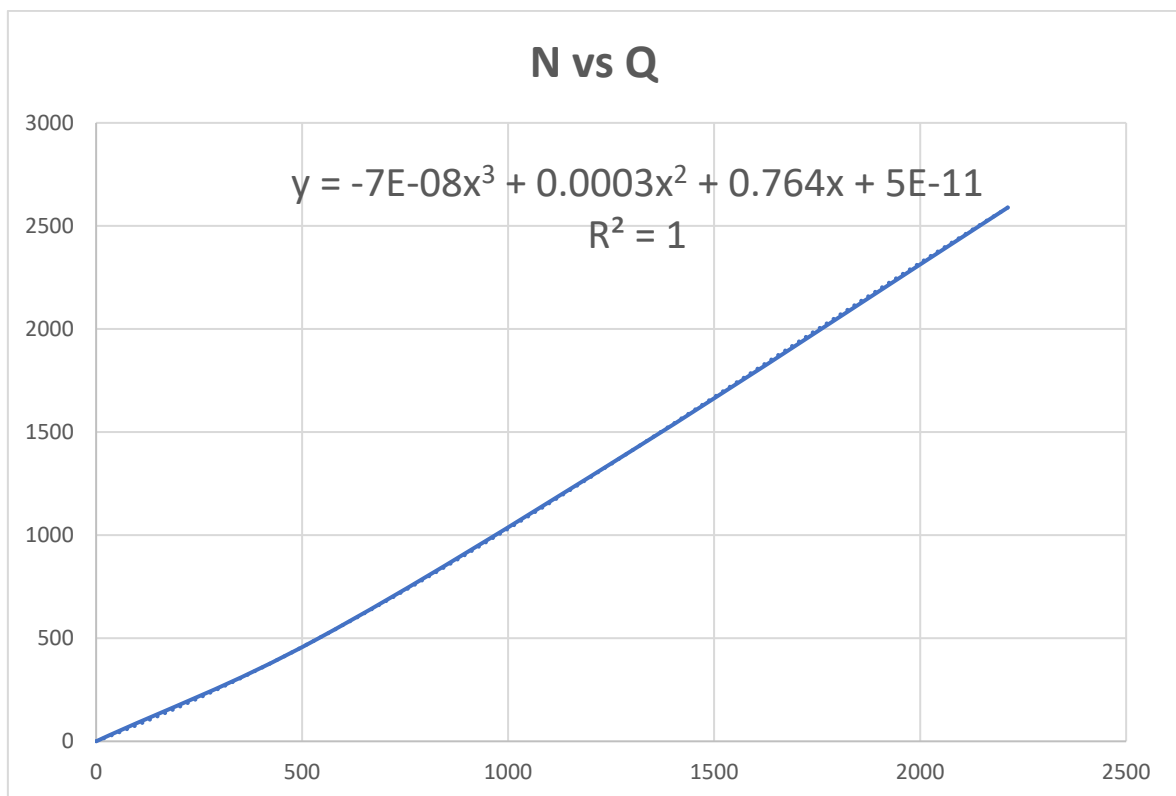
Tabla 51: Coeficiente para el Cálculo de Volumen Aliviado para L=250m

H	S	Q	N
0	0.00	0	0
1	1,042,167.80	553.6808648	566.3314868
2	2,141,607.31	1566.045976	1377.913907
3	3,304,687.61	2877.010167	2356.473863

Tabla 52: Volumen Aliviado para L=250m

b) Gráfico



Gráfico 26: N vs Q para L=250m

4.3.2.3.11. L=275

a) Cálculo

Cd =	0.75
L =	275.00

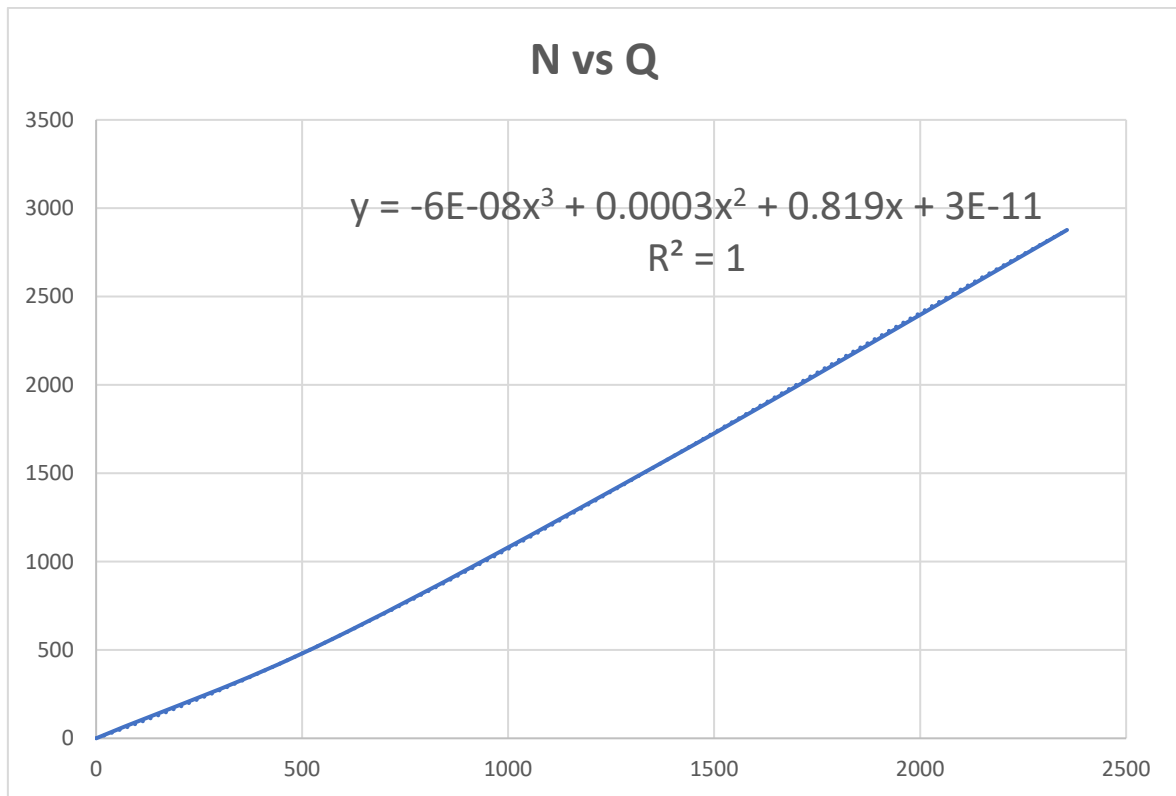
Tabla 53: Coeficiente para el Cálculo de Volumen Aliviado para L=275m

H	S	Q	N
0	0.00	0	0
1	1,042,167.80	609.0489512	594.01553
2	2,141,607.31	1722.650574	1456.216205
3	3,304,687.61	3164.711184	2500.324371

Tabla 54: Volumen Aliviado para L=275m

b) Gráfico



Gráfico 27: N vs Q para L=275m

4.3.2.3.12. L=300

a) Cálculo

Cd =	0.75
L =	300.00

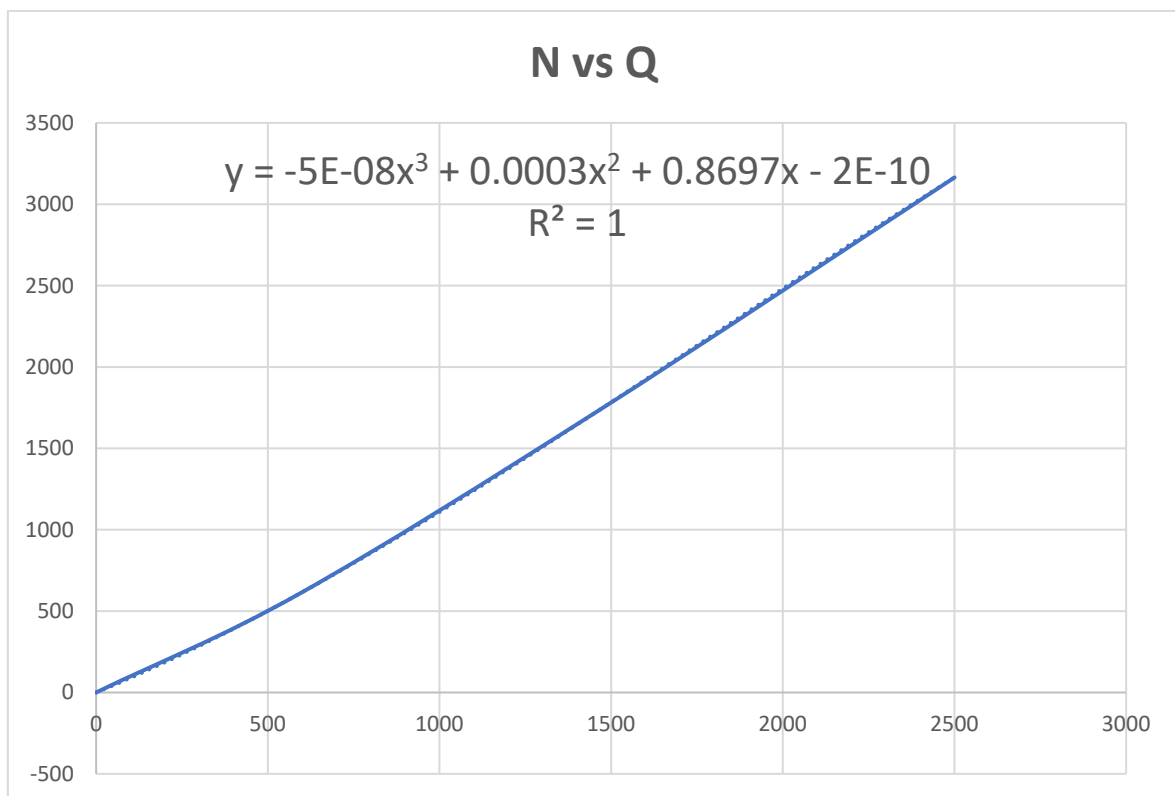
Tabla 55: Coeficiente para el Cálculo de Volumen Aliviado para L=300m

H	S	Q	N
0	0.00	0	0
1	1,042,167.80	664.4170377	621.6995732
2	2,141,607.31	1879.255172	1534.518504
3	3,304,687.61	3452.4122	2644.17488

Tabla 56: Volumen Aliviado para L=300m

b) Gráfico



Gráfico 28: N vs Q para L=300m

4.3.2.3.13. L=325

a) Cálculo

Cd =	0.75
L =	325.00

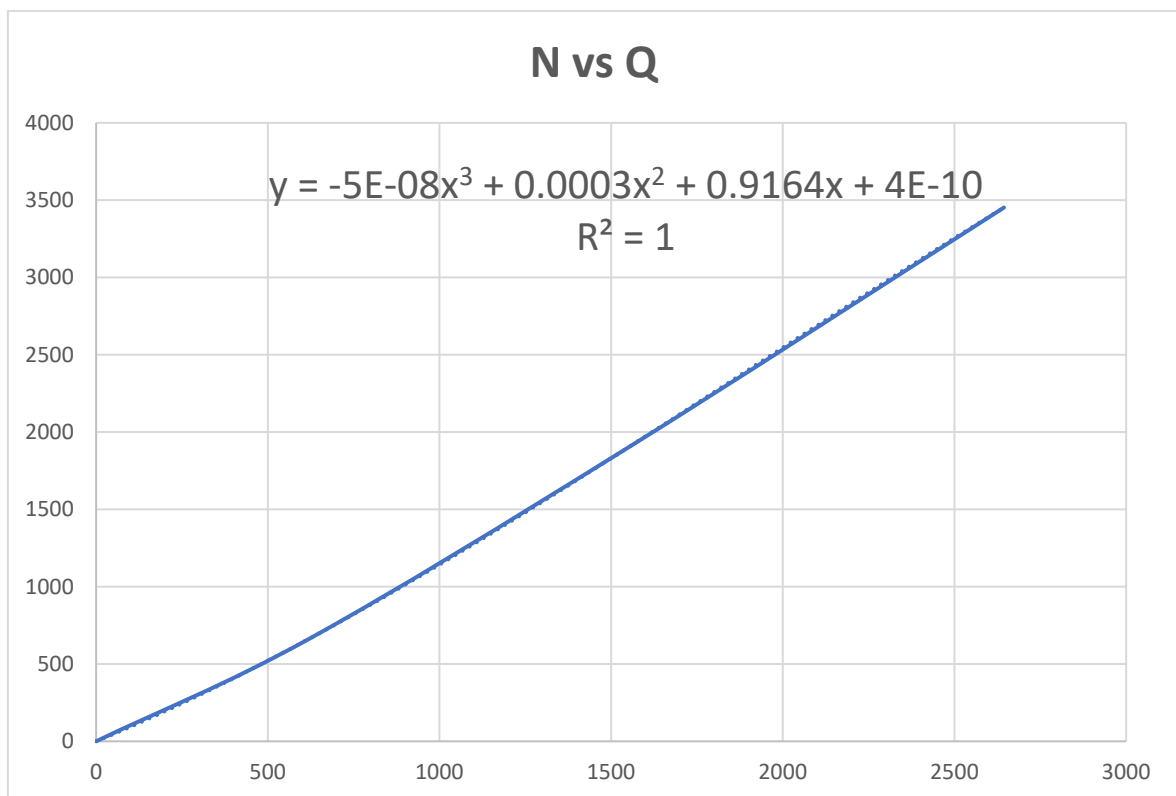
Tabla 57: Coeficiente para el Cálculo de Volumen Aliviado para L=325m

H	S	Q	N
0	0.00	0	0
1	1,042,167.80	719.7851242	649.3836165
2	2,141,607.31	2035.859769	1612.820803
3	3,304,687.61	3740.113217	2788.025388

Tabla 58: Volumen Aliviado para L=325m

b) Gráfico



Gráfico 29: N vs Q para L=325m

4.3.2.3.14. L=350

a) Cálculo

Cd =	0.75
L =	350.00

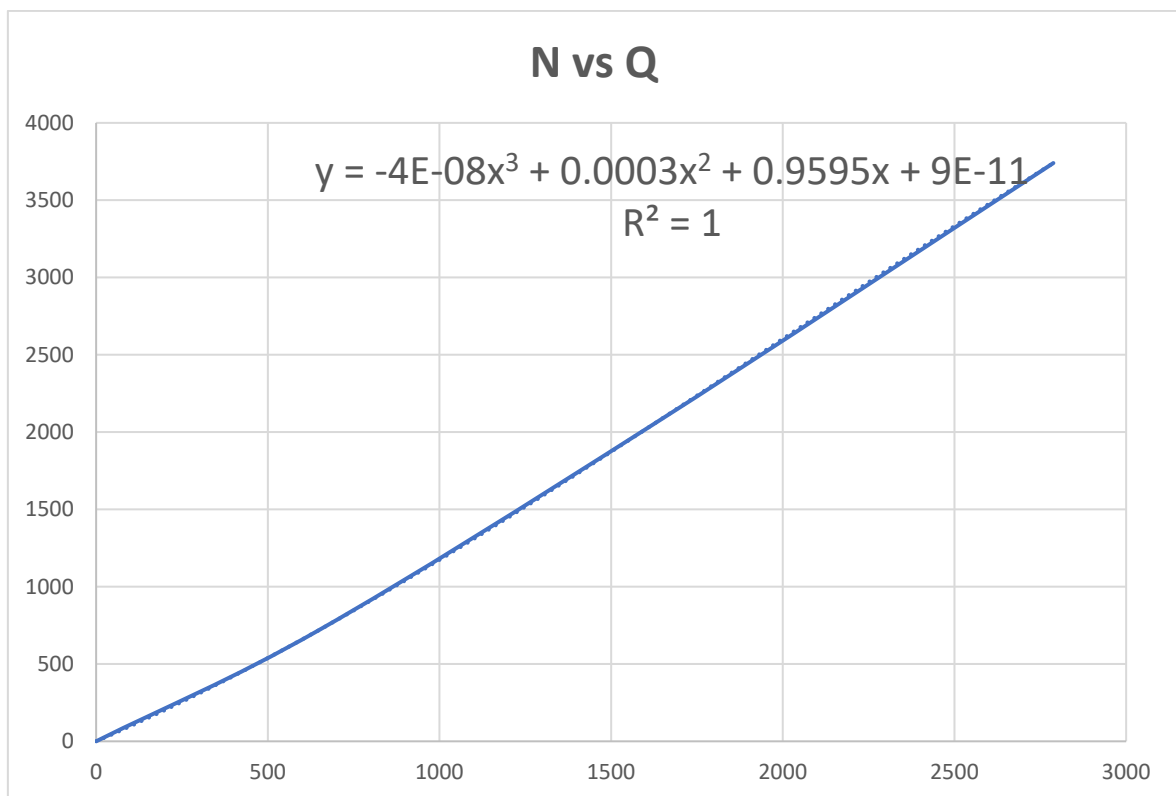
Tabla 59: Coeficiente para el Cálculo de Volumen Aliviado para L=350m

H	S	Q	N
0	0.00	0	0
1	1,042,167.80	775.1532107	677.0676597
2	2,141,607.31	2192.464367	1691.123102
3	3,304,687.61	4027.814234	2931.875896

Tabla 60: Volumen Aliviado para L=350m

b) Gráfico



Gráfico 30: N vs Q para L=350m

4.3.3. Embalse 3

4.3.3.1. Cálculos

ALTURA (m)	COTA (msnm)	AREA PARCIAL (m2)	AREA ACUMULADA (m2)	AREA MEDIA (m2)	VOLUMEN (m3)	VOLUMEN ACUMULADO (m3)	VOLUMEN ACUMULADO (MMC)
0	573	0.00	0.00	0.00	0.00	0.00	0.00
1	574	29,604.63	29,604.63	14,802.31	14,802.31	14,802.31	0.01
2	575	25,521.11	55,125.74	42,365.18	42,365.18	57,167.50	0.06
3	576	30,987.88	86,113.62	70,619.68	70,619.68	127,787.18	0.13
4	577	29,732.98	115,846.61	100,980.11	100,980.11	228,767.29	0.23
5	578	28,338.35	144,184.96	130,015.78	130,015.78	358,783.07	0.36
6	579	55,634.61	199,819.56	172,002.26	172,002.26	530,785.33	0.53
7	580	33,529.83	233,349.40	216,584.48	216,584.48	747,369.81	0.75
8	581	30,447.45	263,796.85	248,573.12	248,573.12	995,942.93	1.00
9	582	51,797.92	315,594.77	289,695.81	289,695.81	1,285,638.74	1.29
10	583	42,124.58	357,719.35	336,657.06	336,657.06	1,622,295.80	1.62
11	584	56,502.05	414,221.40	385,970.38	385,970.38	2,008,266.18	2.01
12	585	44,977.78	459,199.18	436,710.29	436,710.29	2,444,976.47	2.44
13	586	58,781.37	517,980.55	488,589.86	488,589.86	2,933,566.33	2.93
14	587	60,937.76	578,918.31	548,449.43	548,449.43	3,482,015.76	3.48
15	588	51,682.52	630,600.83	604,759.57	604,759.57	4,086,775.33	4.09
16	589	49,936.51	680,537.34	655,569.08	655,569.08	4,742,344.41	4.74
17	590	48,856.52	729,393.86	704,965.60	704,965.60	5,447,310.01	5.45
18	591	36,829.89	766,223.76	747,808.81	747,808.81	6,195,118.82	6.20
19	592	37,538.33	803,762.09	784,992.92	784,992.92	6,980,111.74	6.98
20	593	34,595.06	838,357.14	821,059.61	821,059.61	7,801,171.36	7.80
21	594	28,724.11	867,081.26	852,719.20	852,719.20	8,653,890.56	8.65
22	595	28,506.10	895,587.36	881,334.31	881,334.31	9,535,224.86	9.54
23	596	25,376.17	920,963.53	908,275.44	908,275.44	10,443,500.31	10.44
24	597	27,458.69	948,422.22	934,692.87	934,692.87	11,378,193.18	11.38
25	598	27,315.79	975,738.01	962,080.11	962,080.11	12,340,273.29	12.34
26	599	23,983.46	999,721.46	987,729.74	987,729.74	13,328,003.03	13.33
27	600	27,869.12	1,027,590.59	1,013,656.03	1,013,656.03	14,341,659.05	14.34
28	601	27,393.86	1,054,984.45	1,041,287.52	1,041,287.52	15,382,946.57	15.38
29	602	36,012.29	1,090,996.74	1,072,990.59	1,072,990.59	16,455,937.17	16.46
30	603	26,196.43	1,117,193.17	1,104,094.95	1,104,094.95	17,560,032.12	17.56
31	604	21,703.75	1,138,896.92	1,128,045.04	1,128,045.04	18,688,077.16	18.69

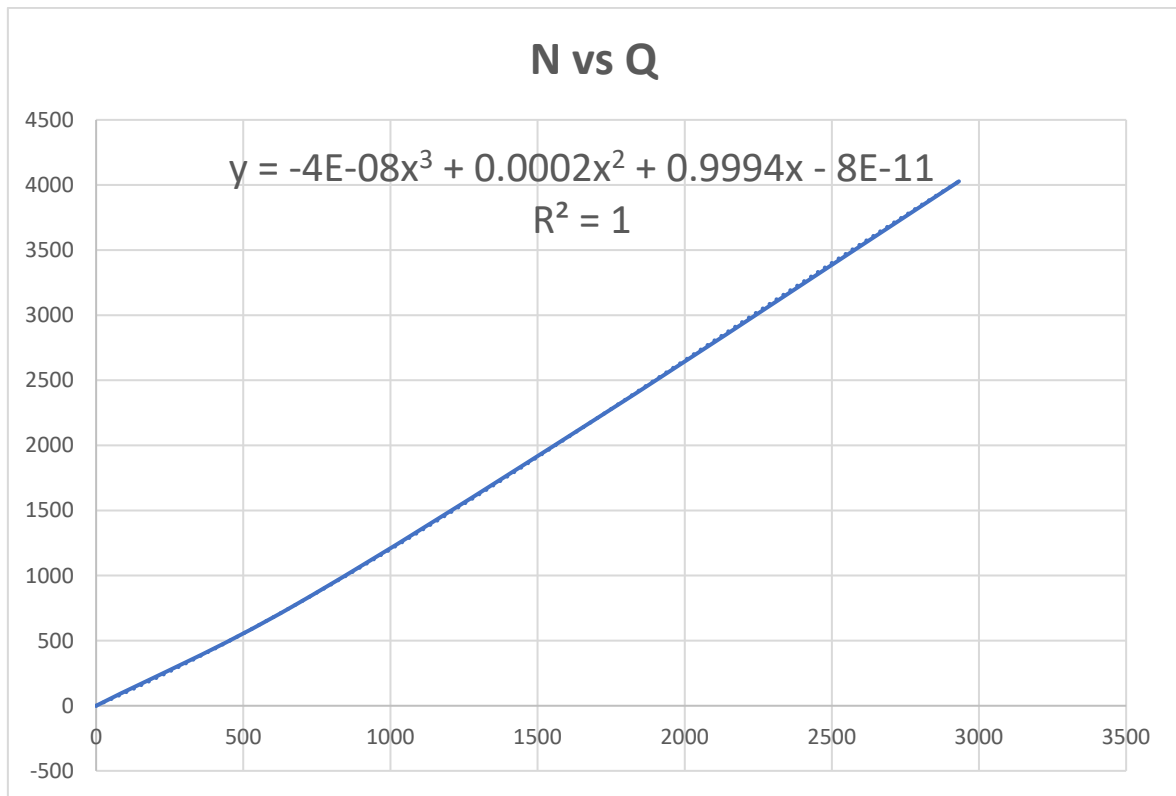
Tabla 61: Cálculos de Volumen Acumulado del Embalse 3

4.3.3.2. Gráfico Curva Cota-Área-Volumen



Gráfico 31: Curva Cota - Área - Volumen del Embalse 3

4.3.3.3. N vs Q

$$Q = \frac{2}{3} \sqrt{2g} \cdot Cd \cdot L \cdot H^{3/2} \quad N = \frac{Q}{2} + \frac{S}{\Delta t}$$

4.3.3.3.1. L=25

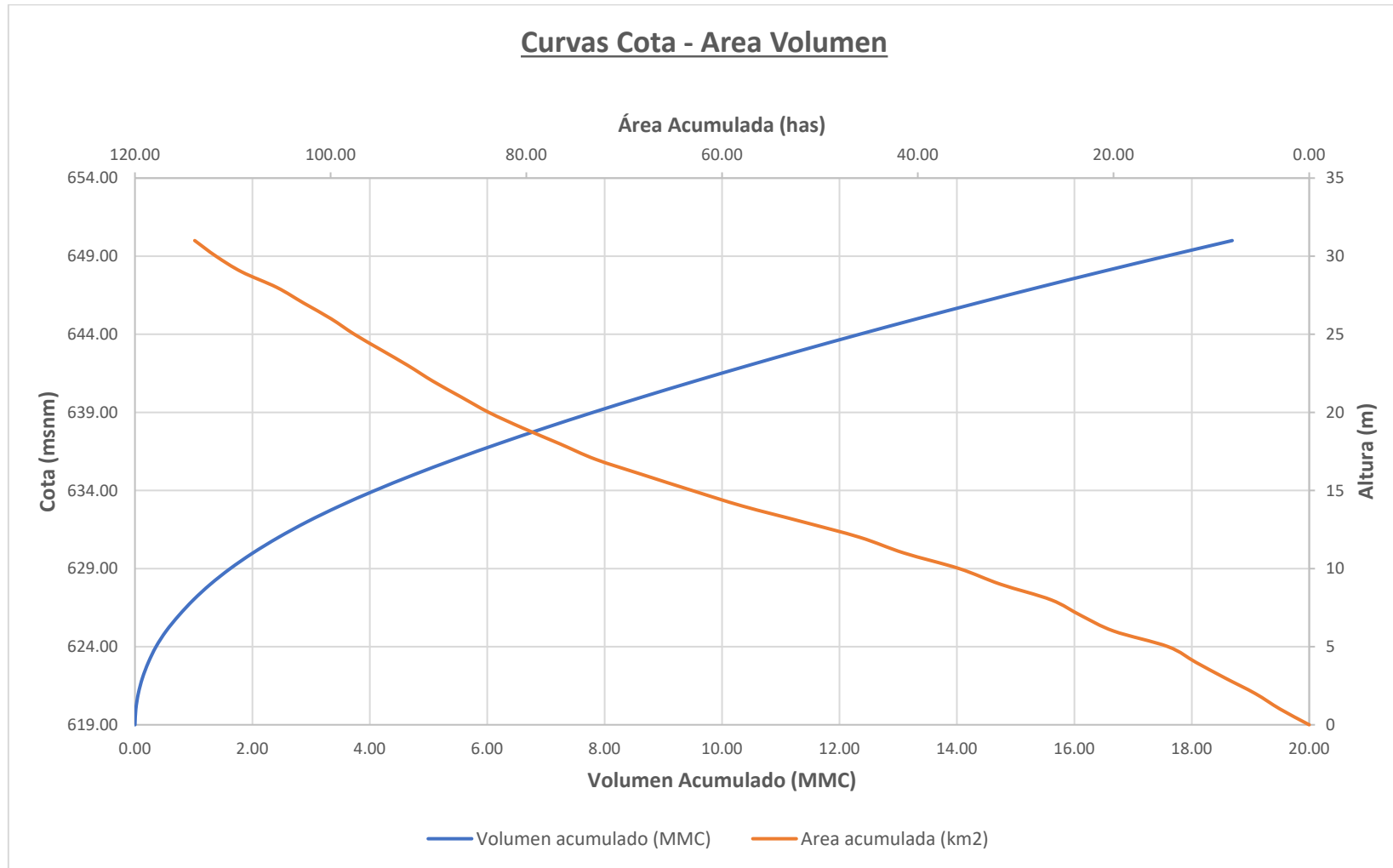
a) Cálculo

Cd =	0.75
L =	25.00

Tabla 62: Coeficiente para el Cálculo de Volumen Aliviado para L=25m

H	S	Q	N
0	0.00	0	0
1	1,072,990.59	55.36808648	325.7369862
2	2,177,085.55	156.6045976	683.0482847
3	3,305,130.59	287.7010167	1061.942339

Tabla 63: Volumen Aliviado para L=25m

b) Gráfico



Gráfico 32: N vs Q para L=25m

4.3.3.3.2. L=50

a) Cálculo

Cd =	0.75
L =	50.00

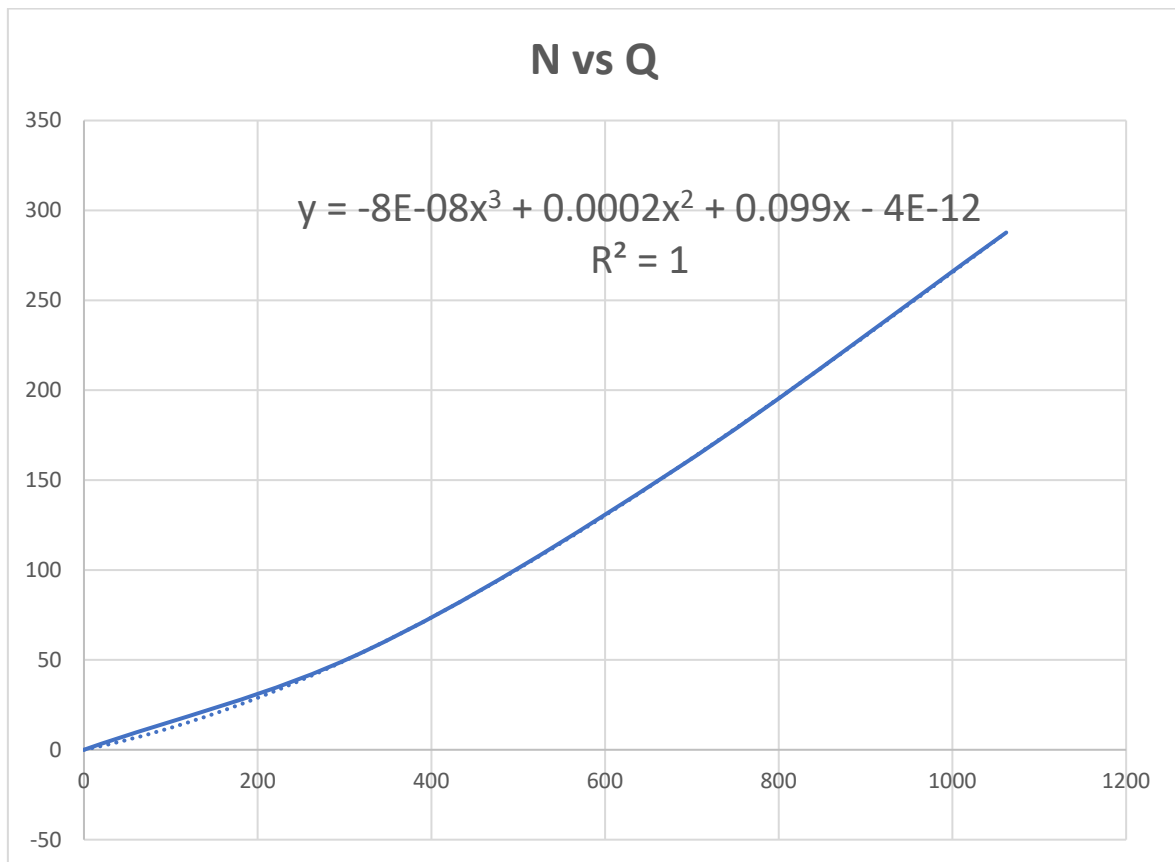
Tabla 64: Coeficiente para el Cálculo de Volumen Aliviado para L=50m

H	S	Q	N
0	0.00	0	0
1	1,072,990.59	110.736173	353.4210294
2	2,177,085.55	313.2091953	761.3505835
3	3,305,130.59	575.4020334	1205.792848

Tabla 65: Volumen Aliviado para L=50m

b) Gráfico



Gráfico 33: N vs Q para L=50m

4.3.3.3. L=75

a) Cálculo

Cd =	0.75
L =	75.00

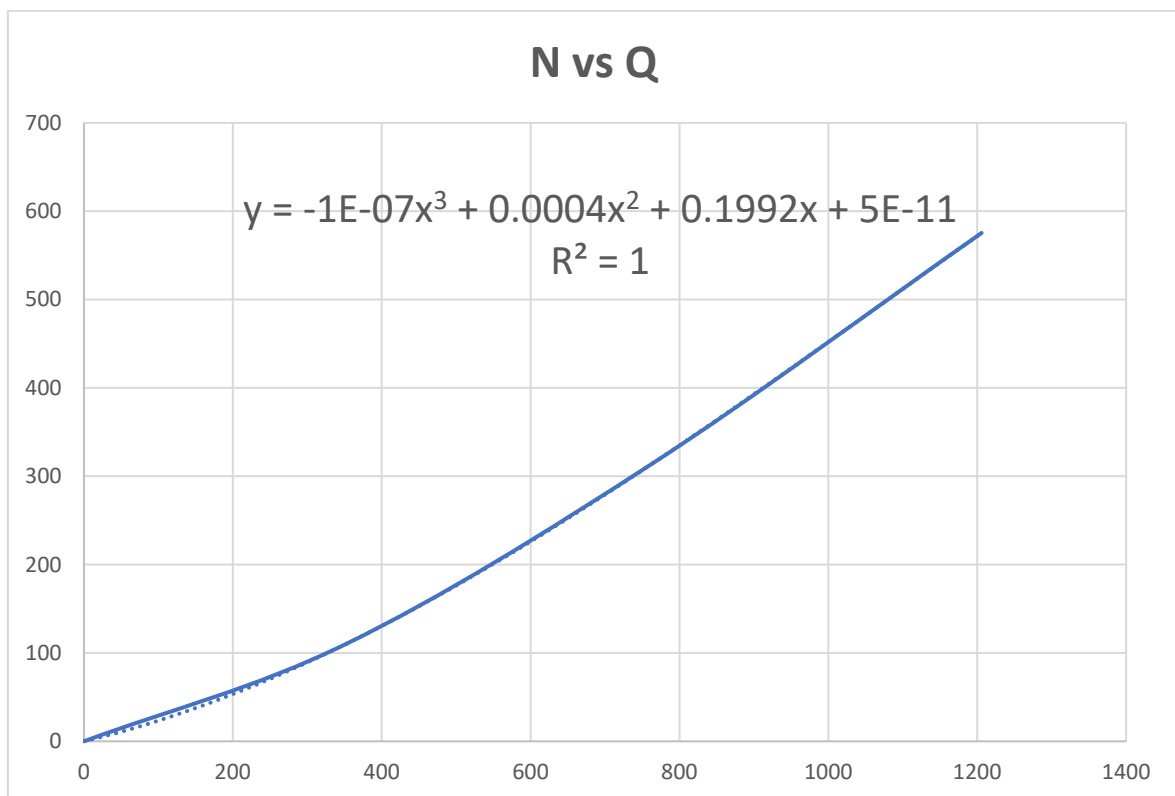
Tabla 66: Coeficiente para el Cálculo de Volumen Aliviado para L=75m

H	S	Q	N
0	0.00	0	0
1	1,072,990.59	166.1042594	381.1050726
2	2,177,085.55	469.8137929	839.6528823
3	3,305,130.59	863.10305	1349.643356

Tabla 67: Volumen Aliviado para L=75m

b) Gráfico



Gráfico 34: N vs Q para L=75m

4.3.3.3.4. L=100

a) Cálculo

Cd =	0.75
L =	100.00

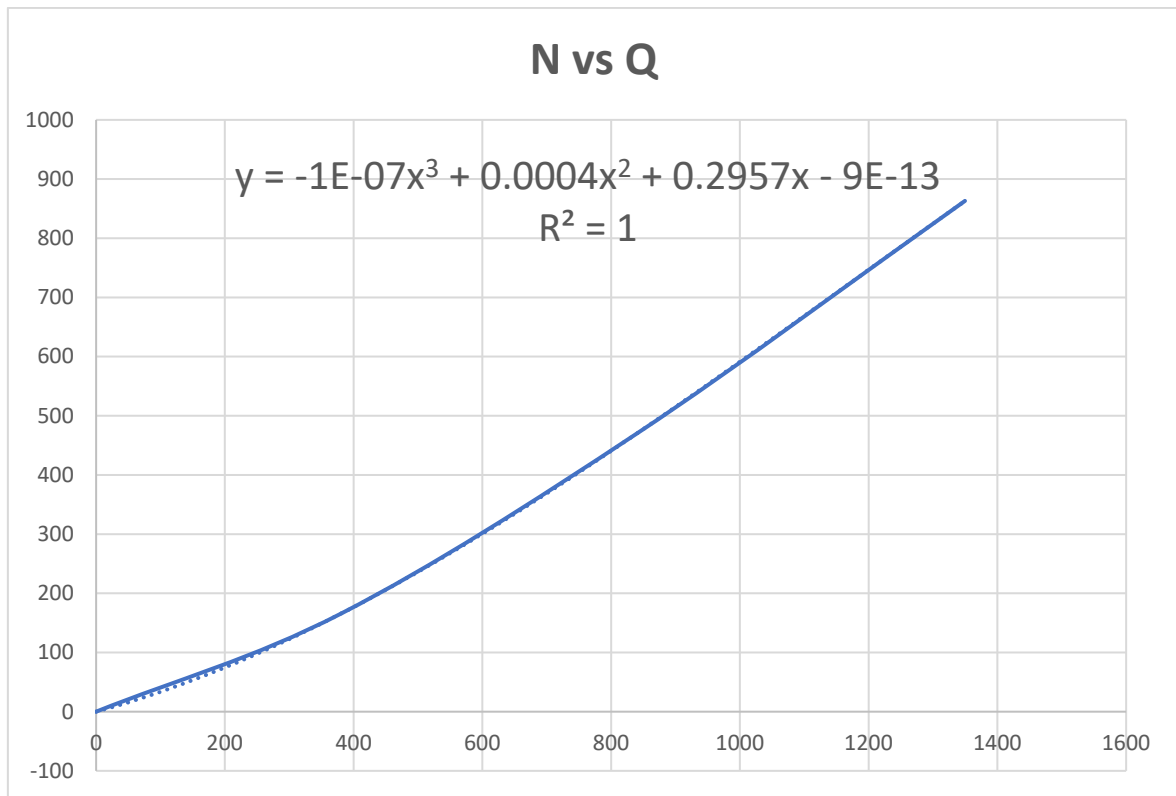
Tabla 68: Coeficiente para el Cálculo de Volumen Aliviado para L=100m

H	S	Q	N
0	0.00	0	0
1	1,072,990.59	221.4723459	408.7891159
2	2,177,085.55	626.4183905	917.9551812
3	3,305,130.59	1150.804067	1493.493864

Tabla 69: Volumen Aliviado para L=100m

b) Gráfico



Gráfico 35: N vs Q para L=100m

4.3.3.3.5. L=125

a) Cálculo

Cd =	0.75
L =	125.00

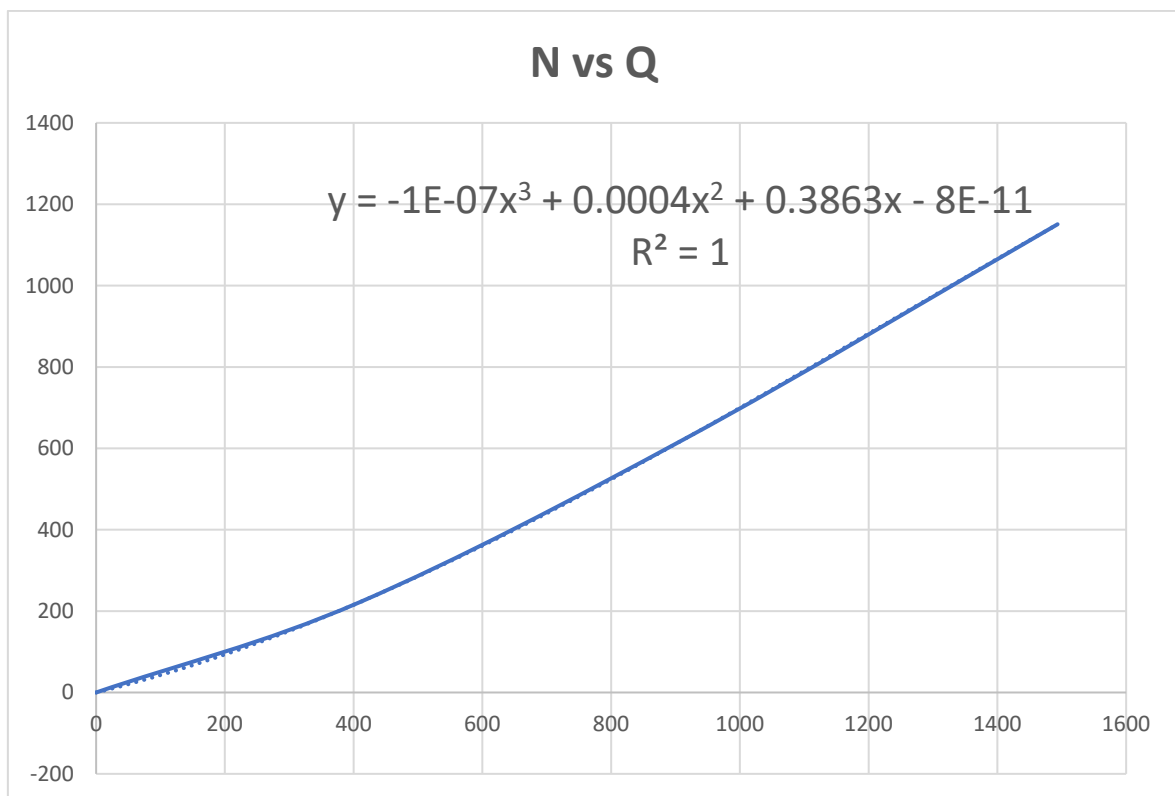
Tabla 70: Coeficiente para el Cálculo de Volumen Aliviado para L=125m

H	S	Q	N
0	0.00	0	0
1	1,072,990.59	276.8404324	436.4731591
2	2,177,085.55	783.0229882	996.25748
3	3,305,130.59	1438.505083	1637.344373

Tabla 71: Volumen Aliviado para L=125m

b) Gráfico



Gráfico 36: N vs Q para L=125m

4.3.3.3.6. L=150

a) Cálculo

Cd =	0.75
L =	150.00

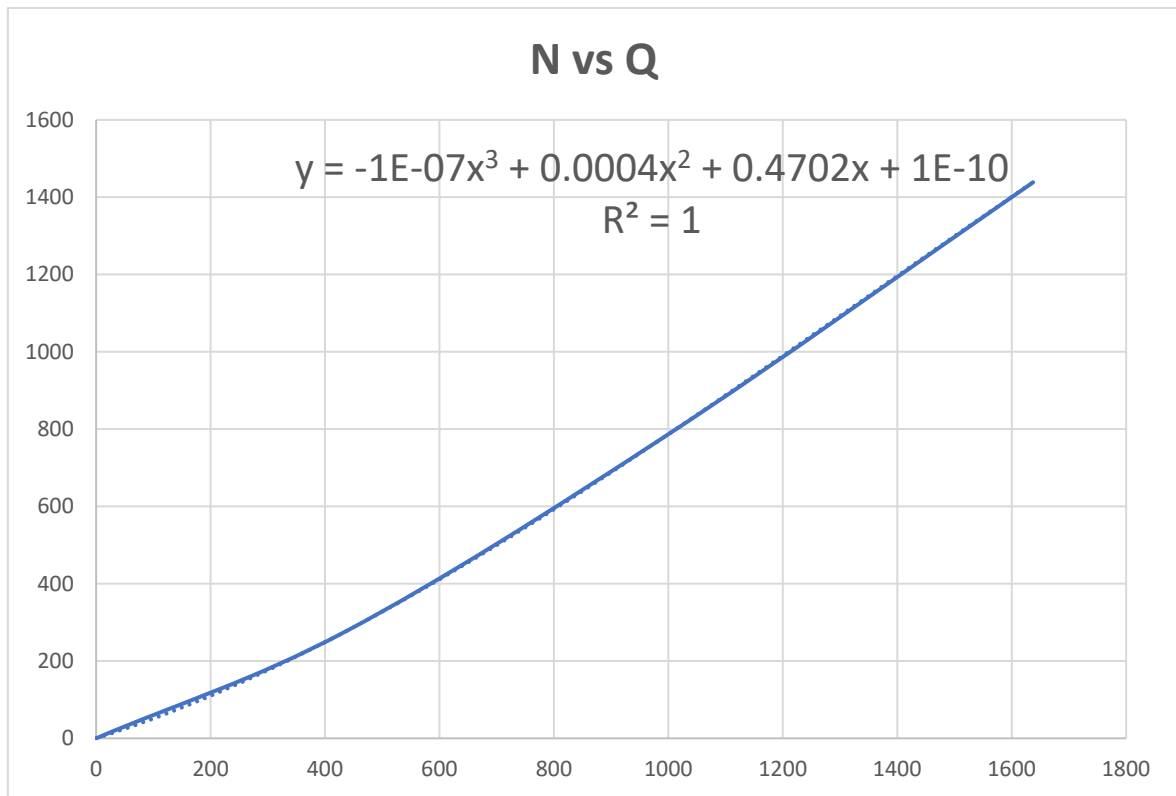
Tabla 72: Coeficiente para el Cálculo de Volumen Aliviado para L=150m

H	S	Q	N
0	0.00	0	0
1	1,072,990.59	332.2085189	464.1572024
2	2,177,085.55	939.6275858	1074.559779
3	3,305,130.59	1726.2061	1781.194881

Tabla 73: Volumen Aliviado para L=150m

b) Gráfico



Gráfico 37: N vs Q para L=150m

4.3.3.3.7. L=175

a) Cálculo

Cd =	0.75
L =	175.00

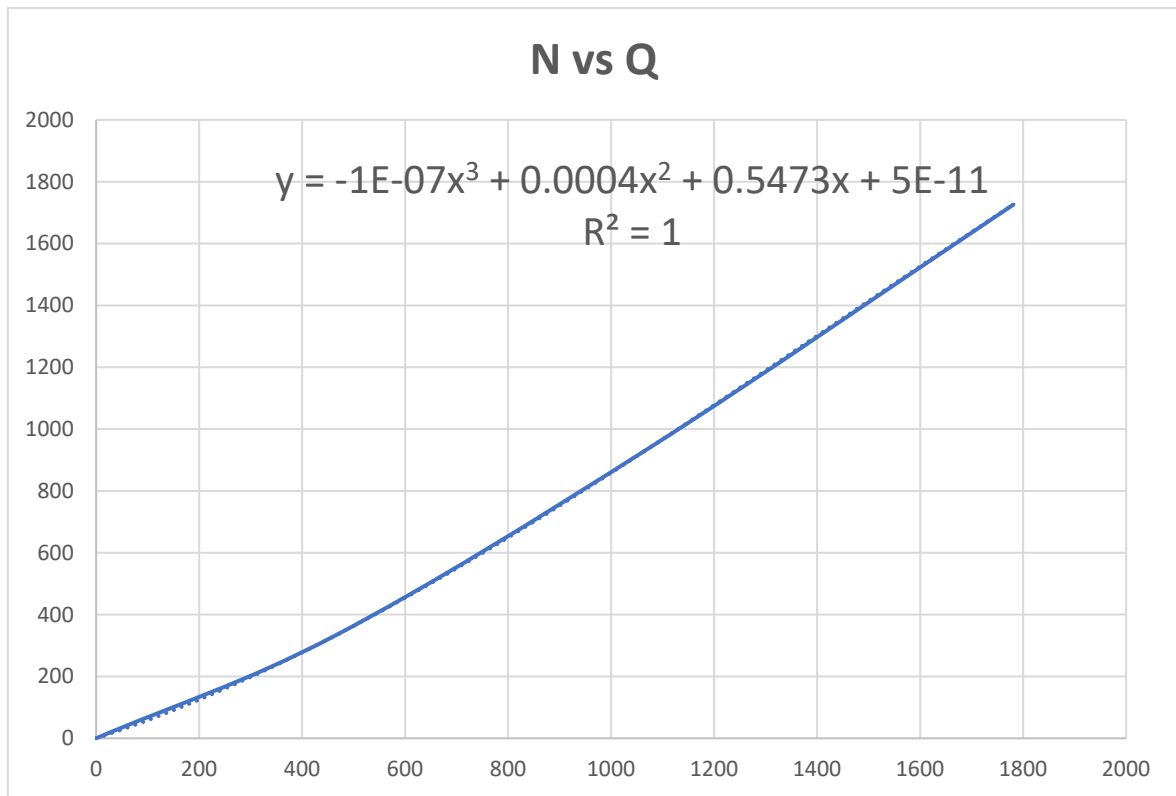
Tabla 74: Coeficiente para el Cálculo de Volumen Aliviado para L=175m

H	S	Q	N
0	0.00	0	0
1	1,072,990.59	387.5766053	491.8412456
2	2,177,085.55	1096.232183	1152.862078
3	3,305,130.59	2013.907117	1925.045389

Tabla 75: Volumen Aliviado para 175m

b) Gráfico



Gráfico 38: N vs Q para L=175m

4.3.3.3.8. L=200

a) Cálculo

Cd =	0.75
L =	200.00

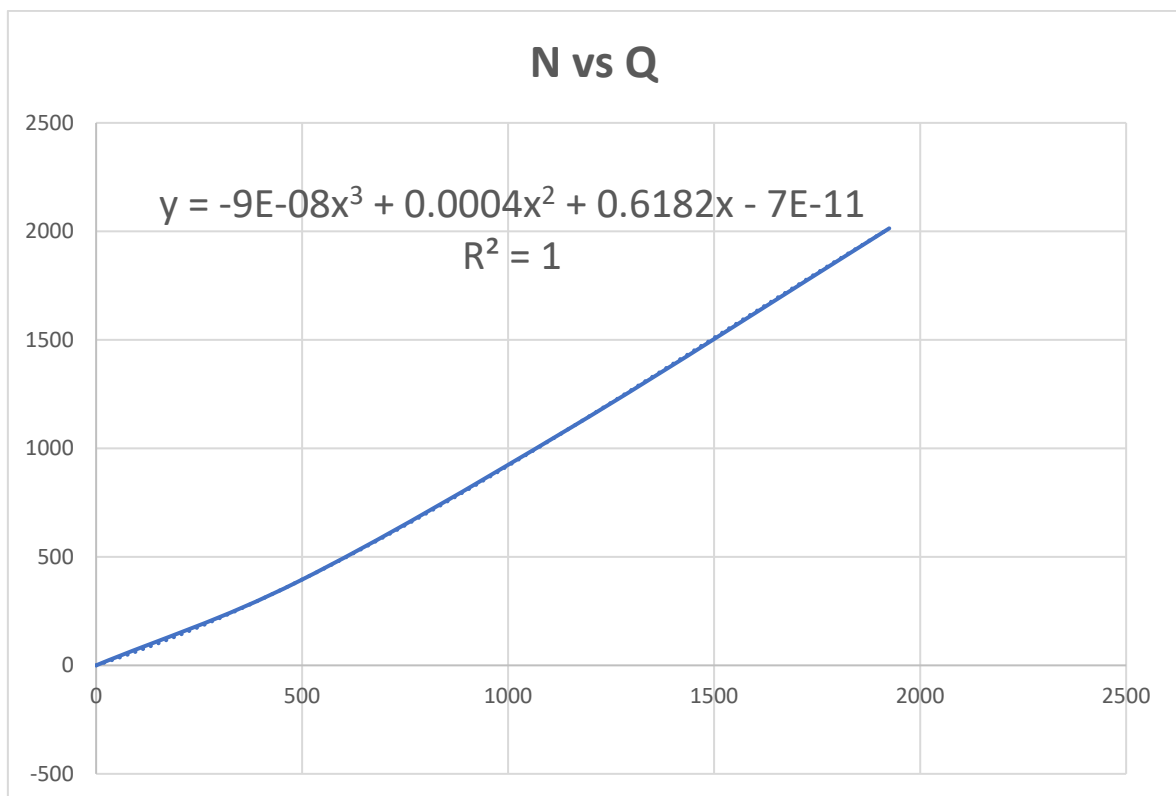
Tabla 76: Coeficiente para el Cálculo de Volumen Aliviado para L=200m

H	S	Q	N
0	0.00	0	0
1	1,072,990.59	442.9446918	519.5252888
2	2,177,085.55	1252.836781	1231.164376
3	3,305,130.59	2301.608133	2068.895898

Tabla 77: Volumen Aliviado para L=200m

b) Gráfico



Gráfico 39: N vs Q para L=200m

4.3.3.3.9. L=225

a) Cálculo

Cd =	0.75
L =	225.00

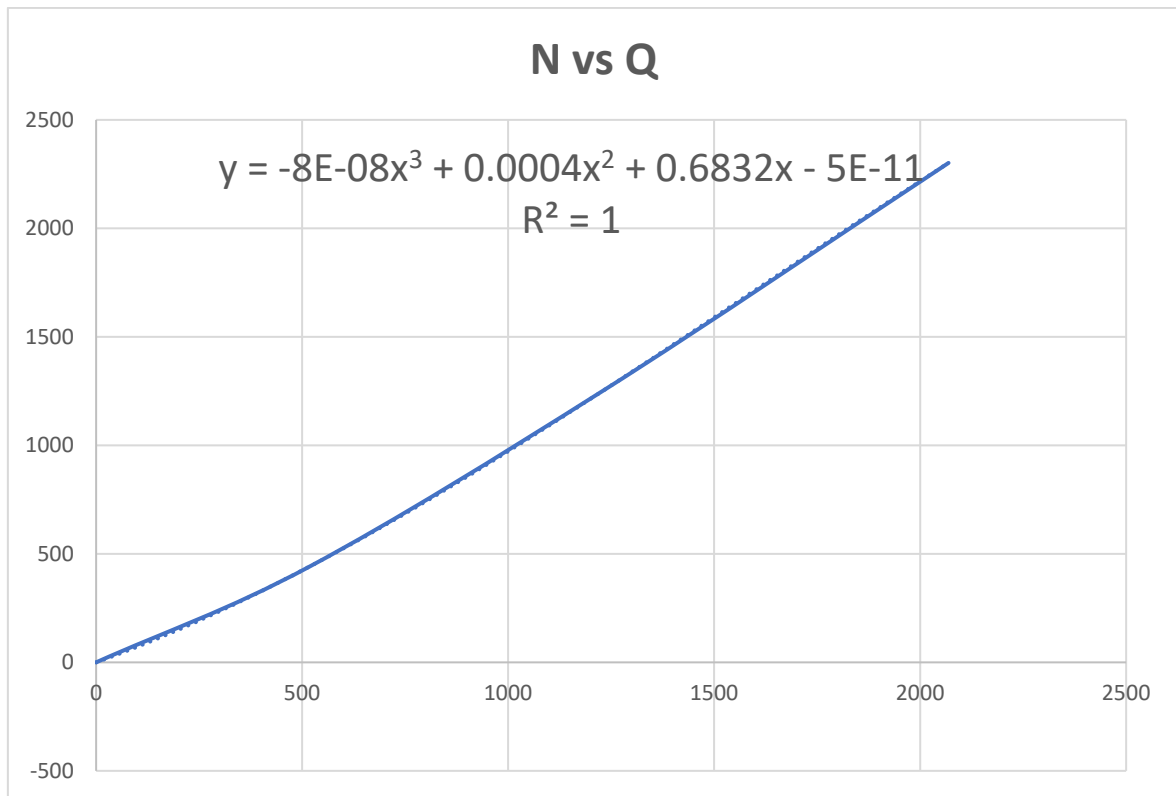
Tabla 78: Coeficiente para el Cálculo de Volumen Aliviado para L=225m

H	S	Q	N
0	0.00	0	0
1	1,072,990.59	498.3127783	547.2093321
2	2,177,085.55	1409.441379	1309.466675
3	3,305,130.59	2589.30915	2212.746406

Tabla 79: Volumen Aliviado para L=225m

b) Gráfico



Gráfico 40: N vs Q para L=225m

4.3.3.3.10. L=250

a) Cálculo

Cd =	0.75
L =	250.00

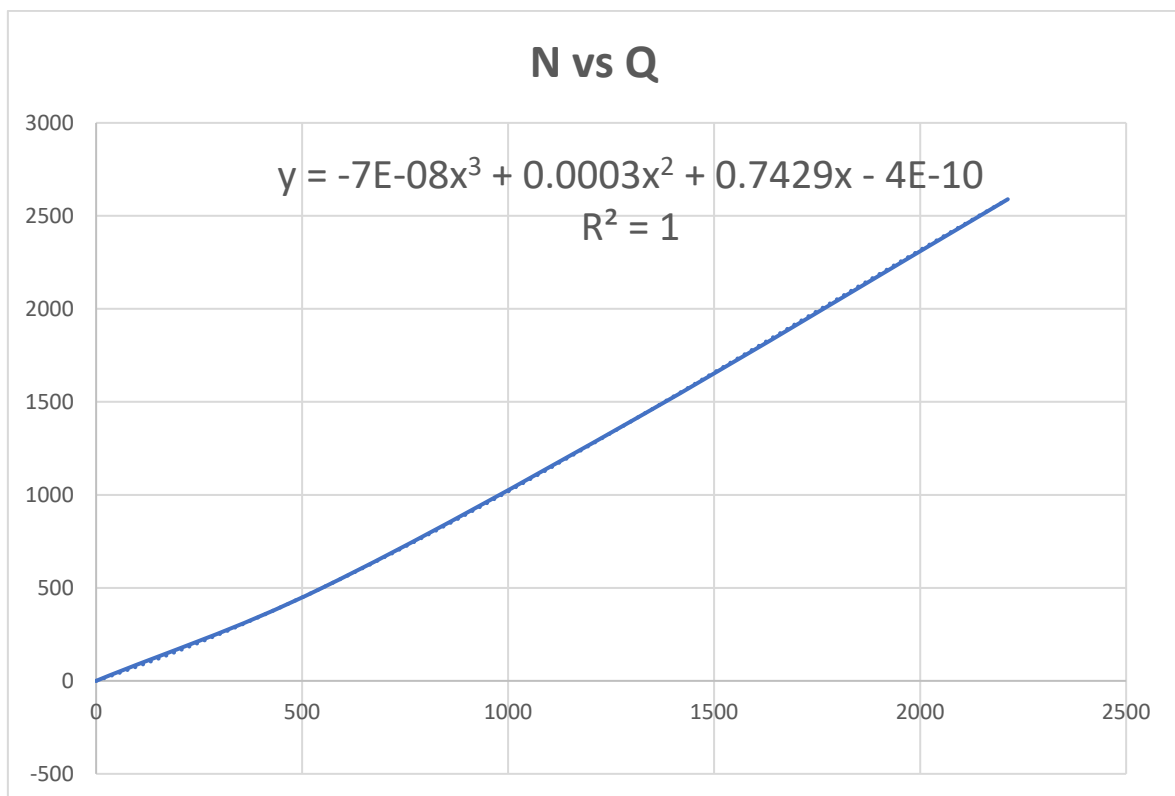
Tabla 80: Coeficiente para el Cálculo de Volumen Aliviado para L=250m

H	S	Q	N
0	0.00	0	0
1	1,072,990.59	553.6808648	574.8933753
2	2,177,085.55	1566.045976	1387.768974
3	3,305,130.59	2877.010167	2356.596914

Tabla 81: Volumen Aliviado para L=250m

b) Gráfico



Gráfico 41: N vs Q para L=250m

4.3.3.3.11. L=275

a) Cálculo

Cd =	0.75
L =	275.00

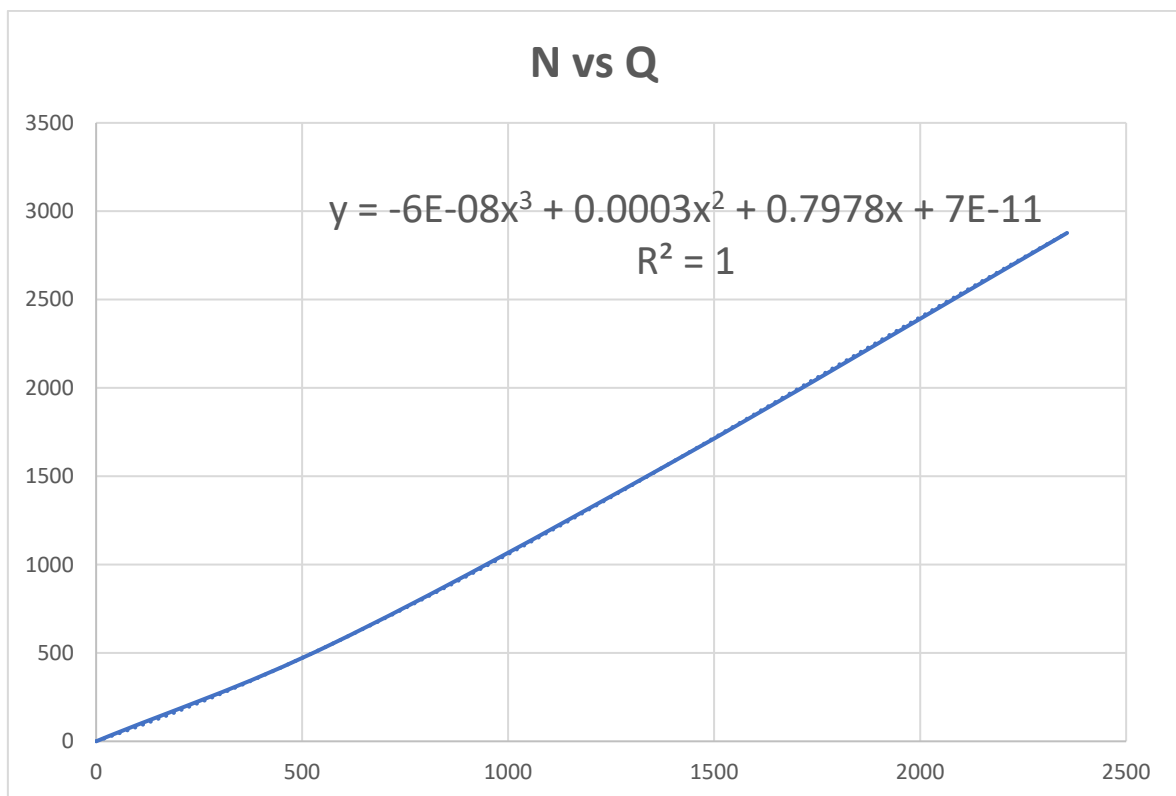
Tabla 82: Coeficiente para el Cálculo de Volumen Aliviado para L=275m

H	S	Q	N
0	0.00	0	0
1	1,072,990.59	609.0489512	602.5774186
2	2,177,085.55	1722.650574	1466.071273
3	3,305,130.59	3164.711184	2500.447423

Tabla 83: Volumen Aliviado para L=275m

b) Gráfico



Gráfico 42: N vs Q para L=275m

4.3.3.3.12. L=300

a) Cálculo

Cd =	0.75
L =	300.00

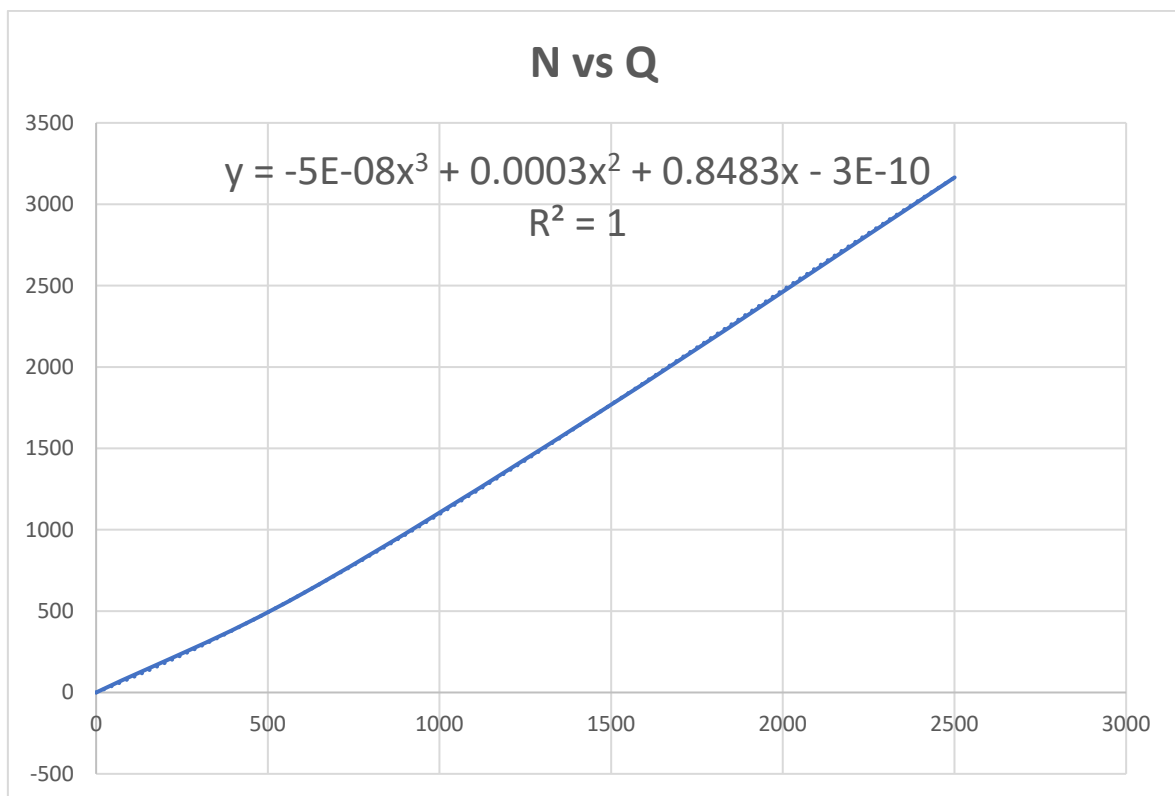
Tabla 84: Coeficiente para el Cálculo de Volumen Aliviado para L=300m

H	S	Q	N
0	0.00	0	0
1	1,072,990.59	664.4170377	630.2614618
2	2,177,085.55	1879.255172	1544.373572
3	3,305,130.59	3452.4122	2644.297931

Tabla 85: Volumen Aliviado para L=300m

b) Gráfico



Gráfico 43: N vs Q para L=300m

4.3.3.3.13. L=325

a) Cálculo

Cd =	0.75
L =	325.00

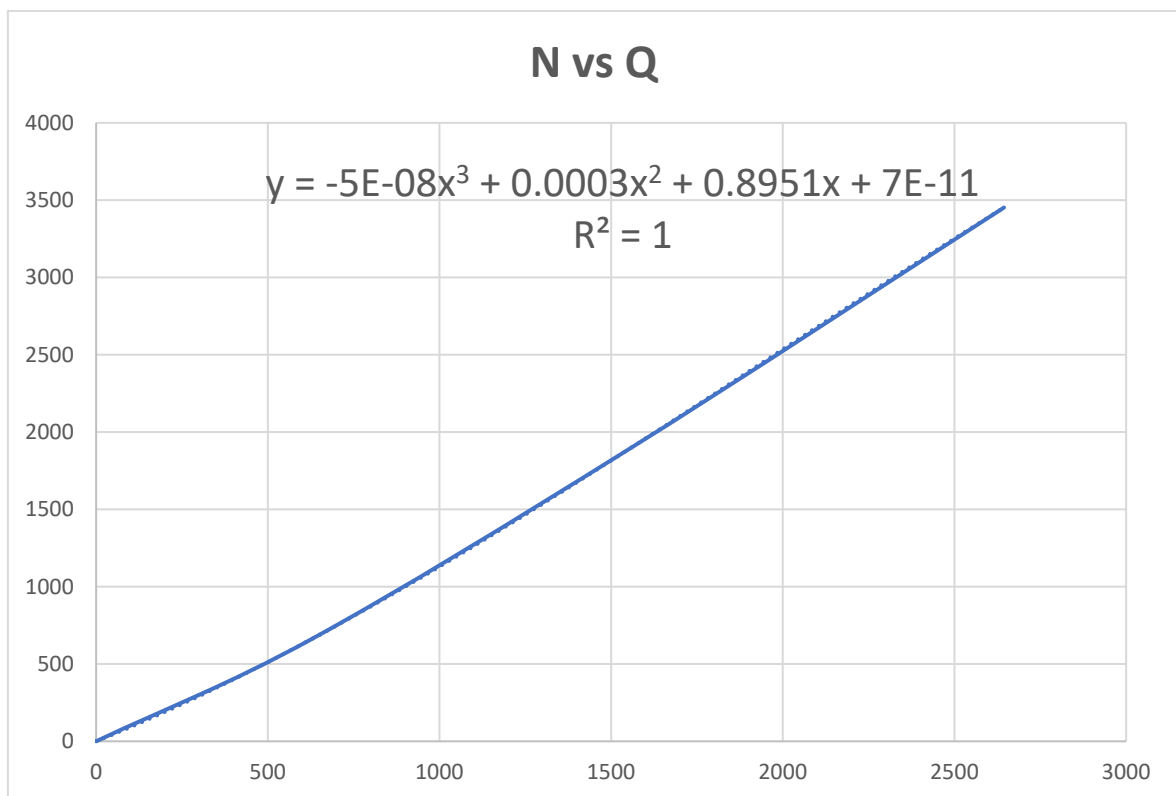
Tabla 86: Coeficiente para el Cálculo de Volumen Aliviado para L=325m

H	S	Q	N
0	0.00	0	0
1	1,072,990.59	719.7851242	657.945505
2	2,177,085.55	2035.859769	1622.675871
3	3,305,130.59	3740.113217	2788.148439

Tabla 87: Volumen Aliviado para L=325m

b) Gráfico



Gráfico 44: N vs Q para L=325m

4.3.3.3.14. L=350

a) Cálculo

Cd =	0.75
L =	350.00

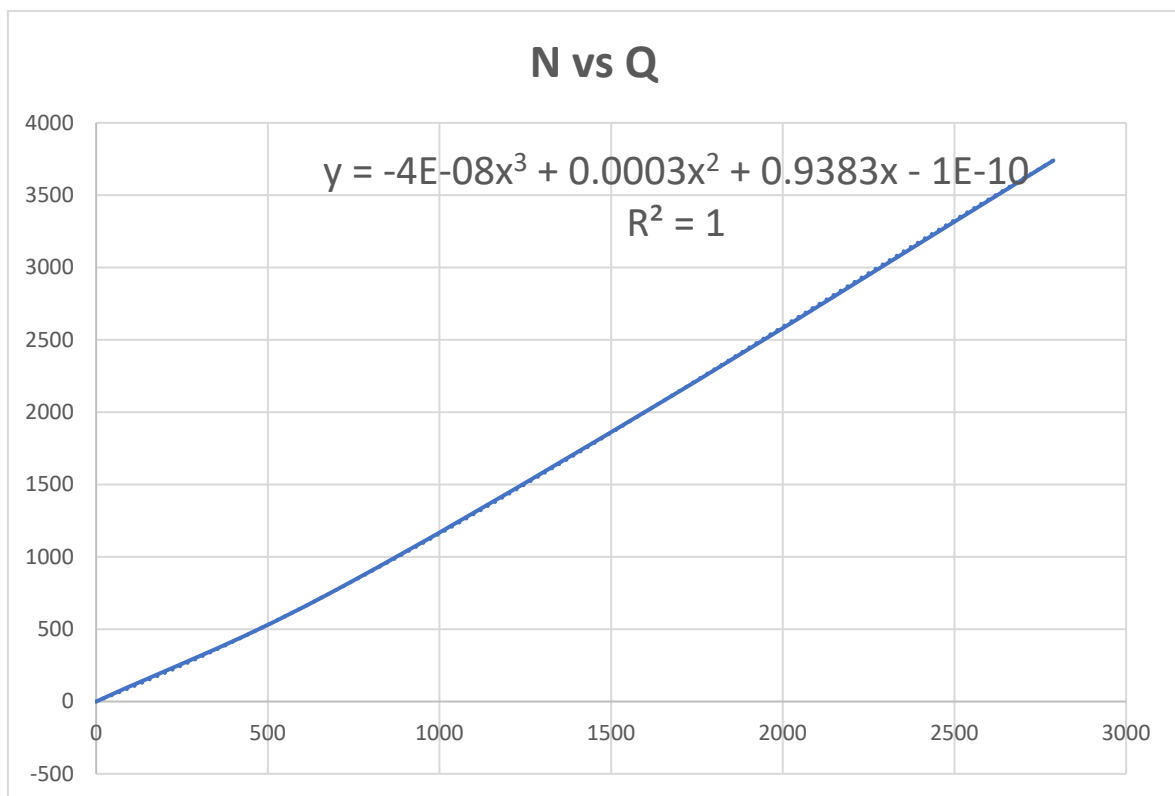
Tabla 88: Coeficiente para el Cálculo de Volumen Aliviado para L=350m

H	S	Q	N
0	0.00	0	0
1	1,072,990.59	775.1532107	685.6295483
2	2,177,085.55	2192.464367	1700.978169
3	3,305,130.59	4027.814234	2931.998948

Tabla 89: Volumen Aliviado para L=350m

b) Gráfico



Gráfico 45: N vs Q para L=350m

4.3.4. Cuadro Resumen de Coeficientes obtenidos de la Línea de Tendencia

$$y = ax^3 + bx^2 + cx + d$$

EMBALSE 1				
L	a	b	c	d
25	-2.E-08	0.0001	0.0611	-1.E-11
50	-4.E-08	0.0002	0.1240	-2.E-11
75	-4.E-08	0.0002	0.1867	-4.E-11
100	-5.E-08	0.0002	0.2481	4.E-11
125	-5.E-08	0.0003	0.3073	2.E-11
150	-5.E-08	0.0003	0.3641	-1.E-10
175	-4.E-08	0.0003	0.4183	7.E-11
200	-4.E-08	0.0003	0.4698	2.E-10
225	-4.E-08	0.0003	0.5187	-4.E-11
250	-4.E-08	0.0002	0.5651	9.E-11
275	-3.E-08	0.0002	0.6090	1.E-10
300	-3.E-08	0.0002	0.6506	-3.E-11
325	-3.E-08	0.0002	0.6901	5.E-10
350	-3.E-08	0.0002	0.7275	4.E-10

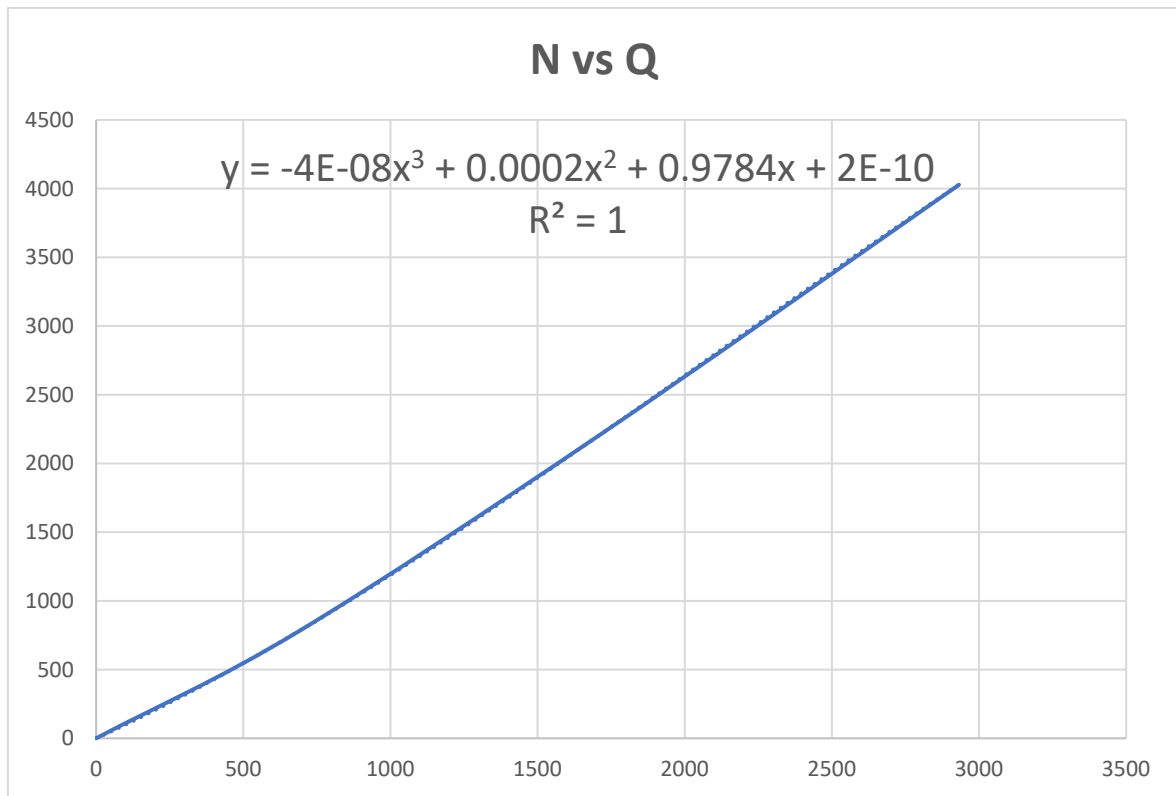
Tabla 90: Cuadro Resumen de Coeficiente obtenidos de la Línea de Tendencia del Embalse 1

EMBALSE 2				
L	a	b	c	d
25	-9.E-08	0.0002	0.1043	4.E-11
50	-1.E-07	0.0004	0.2092	2.E-11
75	-1.E-07	0.0004	0.3093	-5.E-11
100	-1.E-07	0.0004	0.4024	2.E-11
125	-1.E-07	0.0004	0.4881	1.E-11
150	-1.E-07	0.0004	0.5666	2.E-10
175	-9.E-08	0.0004	0.6383	2.E-10
200	-8.E-08	0.0004	0.7039	3.E-10
225	-7.E-08	0.0003	0.7640	5.E-11
250	-6.E-08	0.0003	0.8190	3.E-11
275	-5.E-08	0.0003	0.8697	-2.E-10
300	-5.E-08	0.0003	0.9164	4.E-10
325	-4.E-08	0.0003	0.9595	9.E-11
350	-4.E-08	0.0002	0.9994	-8.E-11

Tabla 91: Cuadro Resumen de Coeficiente obtenidos de la Línea de Tendencia del Embalse 2

EMBALSE 3				
L	a	b	c	d
25	-8.E-08	0.0002	0.0990	-4.E-12
50	-1.E-07	0.0004	0.1992	5.E-11
75	-1.E-07	0.0004	0.2957	-9.E-13
100	-1.E-07	0.0004	0.3863	-8.E-11
125	-1.E-07	0.0004	0.4702	1.E-10
150	-1.E-07	0.0004	0.5473	5.E-11
175	-9.E-08	0.0004	0.6182	-7.E-11
200	-8.E-08	0.0004	0.6832	-5.E-11
225	-7.E-08	0.0003	0.7429	-4.E-10
250	-6.E-08	0.0003	0.7978	7.E-11
275	-5.E-08	0.0003	0.8483	-3.E-10
300	-5.E-08	0.0003	0.8951	7.E-11
325	-4.E-08	0.0003	0.9383	-1.E-10
350	-4.E-08	0.0002	0.9784	2.E-10

Tabla 92: Cuadro Resumen de Coeficiente obtenidos de la Línea de Tendencia del Embalse 3

4.4. Estudio Hidrológico

4.4.1. Análisis de Caudales

- Se realizó el análisis mediante un registro de caudales diarios de 48 años (Datos históricos que se pudieron recopilar, adjunto las tablas en anexos).

- Se obtuvo el promedio de caudales máximos anuales.

4.4.2. Cuadro Resumen de Caudales Promedio Diario por Año

CUADRO RESUMEN			
AÑO	Q PROMEDIO DIARIO (L/S)	AÑO	Q PROMEDIO DIARIO (L/S)
1971	354,893	1995	119,406
1972	359,934	1996	258,862
1973	533,920	1997	99,311
1974	222,833	1998	1,416,729
1975	412,068	1999	330,761
1976	256,090	2000	519,549
1977	350,689	2001	419,231
1978	54,026	2002	284,923
1979	146,683	2003	142,685
1980	37,243	2004	86,451
1981	287,458	2005	123,269
1982	120,193	2006	258,423
1983	814,372	2007	251,681
1984	491,441	2008	352,934
1985	83,055	2009	379,793
1986	154,855	2010	202,962
1987	203,575	2011	177,560
1988	143,192	2012	307,774
1989	327,257	2013	257,688
1990	61,842	2014	176,042
1991	72,601	2015	290,216
1992	96,856	2016	156,775
1993	339,071	2017	715,895
1994	287,313	2018	191,346

PROMEDIO	286,078	(L/S)
MÁXIMA	1,416,729	(L/S)
MINIMA	37,243	(L/S)

Tabla 93: Cuadro Resumen de Caudales Promedio Diario por Año

4.4.3. Intensidad de lluvia

- Para realizar el cálculo de la intensidad de lluvia utilizaremos el software Hydroiila.

4.4.3.1. Duración de la Precipitación

Tendremos una duración de 170 minutos de lluvia ($t = 170 \text{ min}$), por lo tanto, elegiremos la opción " $t < 3h$ "

4.4.3.2. Elección de la Zona y Sub Zona

Hydroiila nos brinda un archivo (.kmz) en el cuál mediante Google Earth Pro podemos ver los límites de las sub zonas, para lo cual en el buscador ingresamos las coordenadas de la estación Huamachuco ($7^{\circ} 49' 52'' \text{ S}$, $78^{\circ} 02' 54.4'' \text{ W}$) y nos indicará que sub zona debemos elegir.



Ilustración 39: Límites de Zonas y Sub Zonas que nos brinda el software Hydroiila

En el mensaje que nos aparece al hacer clic, este indica que la ubicación se encuentra a una Cota = 3290 m.s.n.m., en la zona Sierra, sub zona 5 - a8 y no existe un valor “n” predeterminado para esta zona.

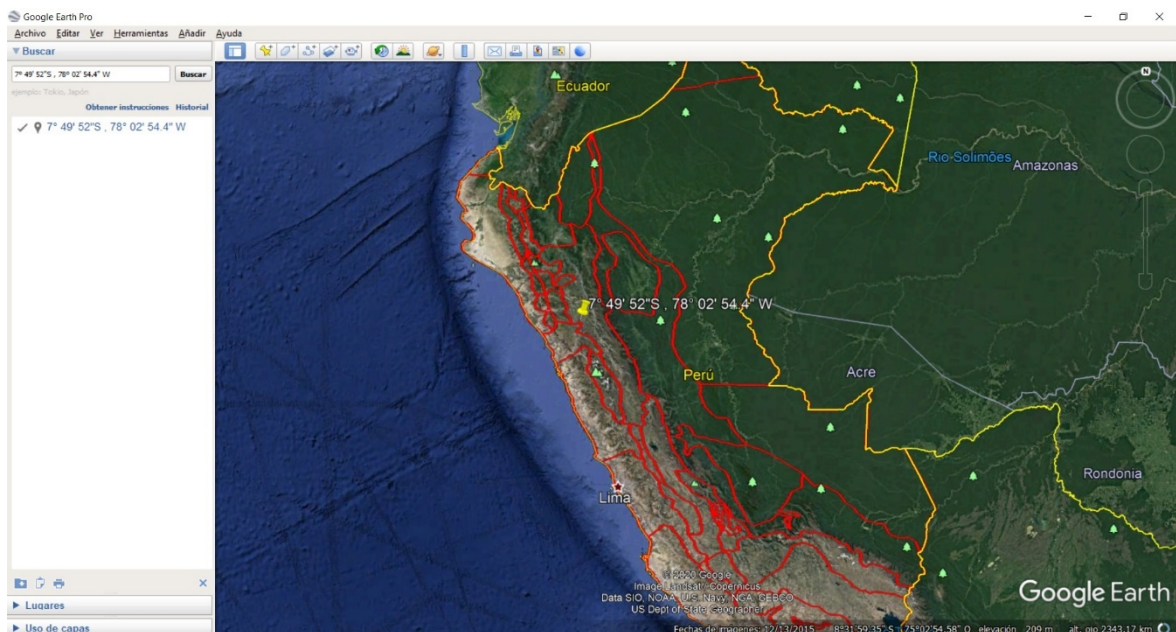

Ilustración 40: Elección de la Zona y Subzona

4.4.3.3. Parámetro “n”

Realizaremos una interpolación entre los datos ya preestablecidos para obtener un valor “n” con respecto a la Sub Zona 5a – 8.

$$y_x = y_0 + \frac{x - x_0}{x_1 - x_0} (y_1 - y_0)$$

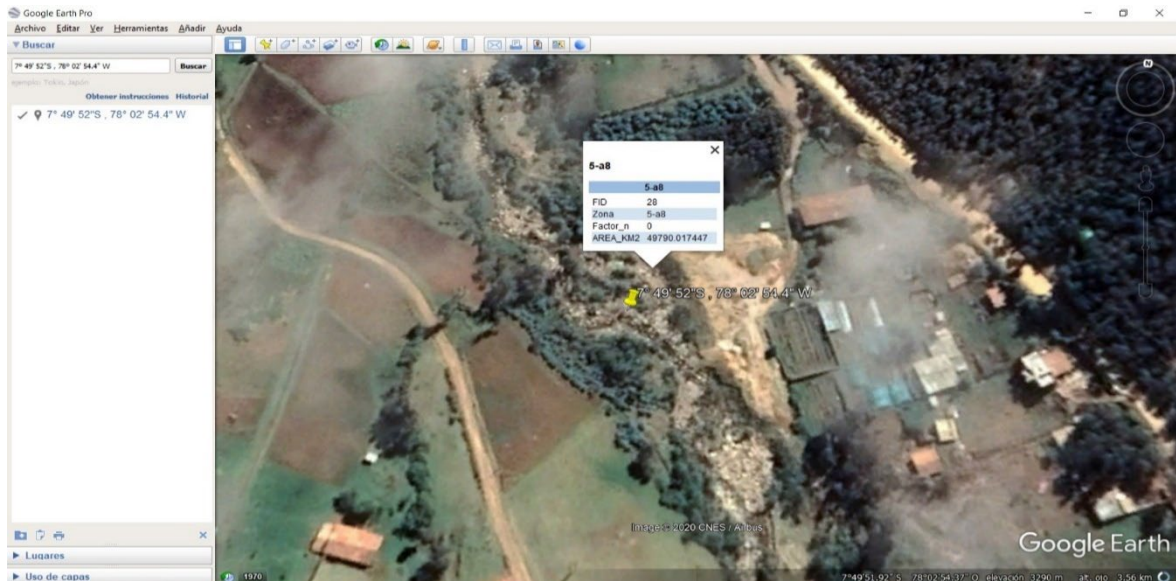
$$x = 8 \quad y = \zeta ?$$

$$x_0 = 5 \quad y_0 = 0.303$$

$$x_1 = 10 \quad y_1 = 0.434$$

$$y = 0.3816 \cong 0.38$$

$$n = 0.38$$

4.4.3.4. Periodo de Retorno

T = 100 años

4.4.3.5. Cálculo

HYDROIILA V1.0

Herramientas Ayudas

DURACIÓN DE PRECIPITACIÓN

t < 3h

t >= 3h

$$i_{(t,T)} = a(1 + K_g \text{Log}T)(t + b)^{n-1}$$

DATOS DE ENTRADA

ZONA Sierra SUBZONA 5a_8

b = 0.4 Eg = 32.225 kg = 0.575 a = 11.458 Cota = 3290 n = 0.38

Dc = Dm = T = 100 t (min) = 170 Intervalo (min) = 5

	n	t(min)	i(mm/hr)	P(mm)	pi-pi(mm)	Int. Par	Prec. Alt
▶	1	5	38.66	3.22	3.22	38.66	0.47
	2	10	35.03	5.84	2.62	31.43	0.49
	3	15	32.18	8.04	2.2	26.45	0.51
	4	20	29.86	9.95	1.91	22.95	0.54
	5	25	27.93	11.64	1.69	20.25	0.57
	6	30	26.3	13.15	1.51	18.11	0.61
	7	35	24.89	14.52	1.37	16.45	0.64
	8	40	23.67	15.78	1.26	15.11	0.69
	9	45	22.59	16.94	1.16	13.95	0.75

Ejecutar Graficos

Exportar Limpiar

Salir

Autores:
-Helms K. Rodríguez Venegas
-Cristhian R. Esquen Lozano

Asesores:
-Ing. Juan P. García Rivera
-Doc. Hans Sánchez Tueros

Ilustración 41: Cálculo en Hydroiila

4.4.3.6. Datos

n	t(min)	i(mm/hr)	P(mm)	pi-pi(mm)	Int. Par	Prec. Alt
1	5	38.66	3.22	3.22	38.66	0.47
2	10	35.03	5.84	2.62	31.43	0.49
3	15	32.18	8.04	2.20	26.45	0.51
4	20	29.86	9.95	1.91	22.95	0.54
5	25	27.93	11.64	1.69	20.25	0.57
6	30	26.30	13.15	1.51	18.11	0.61
7	35	24.89	14.52	1.37	16.45	0.64
8	40	23.67	15.78	1.26	15.11	0.69
9	45	22.59	16.94	1.16	13.95	0.75
10	50	21.63	18.03	1.09	13.03	0.81
11	55	20.77	19.04	1.01	12.13	0.90
12	60	20.00	20.00	0.96	11.47	1.01
13	65	19.29	20.90	0.90	10.80	1.16
14	70	18.65	21.76	0.86	10.29	1.37
15	75	18.06	22.57	0.81	9.77	1.69
16	80	17.52	23.35	0.78	9.42	2.20
17	85	17.01	24.10	0.75	9.03	3.22
18	90	16.55	24.82	0.72	8.65	2.62
19	95	16.11	25.51	0.69	8.30	1.91
20	100	15.71	26.18	0.67	8.01	1.51
21	105	15.33	26.82	0.64	7.69	1.26
22	110	14.97	27.44	0.62	7.48	1.09
23	115	14.63	28.05	0.61	7.28	0.96
24	120	14.32	28.63	0.58	6.98	0.86
25	125	14.02	29.20	0.57	6.84	0.78
26	130	13.73	29.75	0.55	6.64	0.72
27	135	13.46	30.29	0.54	6.50	0.67
28	140	13.21	30.82	0.53	6.31	0.62
29	145	12.96	31.33	0.51	6.09	0.58
30	150	12.73	31.83	0.50	5.97	0.55
31	155	12.51	32.32	0.49	5.83	0.53
32	160	12.30	32.79	0.47	5.68	0.50
33	165	12.09	33.26	0.47	5.64	0.47
34	170	11.90	33.72	0.46	5.50	0.46

Tabla 94: Resultados del Hydroiila

4.4.3.7. Hietograma



Gráfico 46: Hietograma de la Intensidad de Lluvia

4.4.3.8. Curva IDF

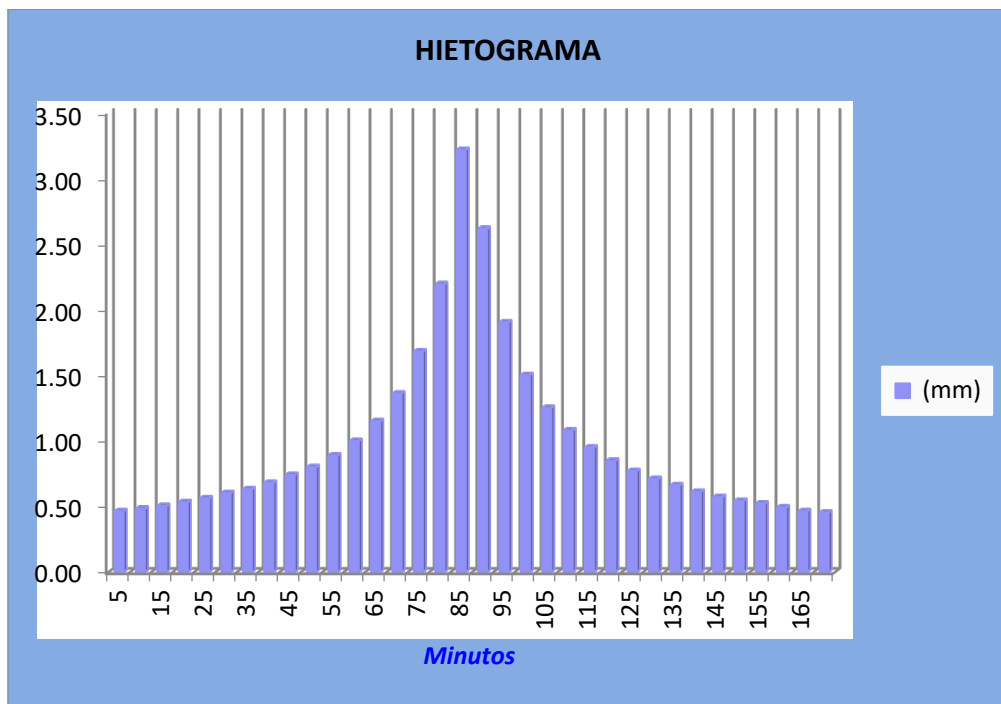

Gráfico 47: Curva IDF

4.4.4. Cálculo del Caudal de Entrada

- Para realizar el cálculo del caudal de entrada utilizaremos el software HEC-HMS.
- Utilizaremos los siguientes datos.

DATOS DE LAS SUBCUENCAS						
SUBCUENCA	CN	LONGITUD (Km)	Cota superior (m)	Cota inferior (m)	AREA (km2)	PENDIENTE (km)
CHICAMA ALTA	71.00	78.17876	3162.25	614.82	2338.98	0.033

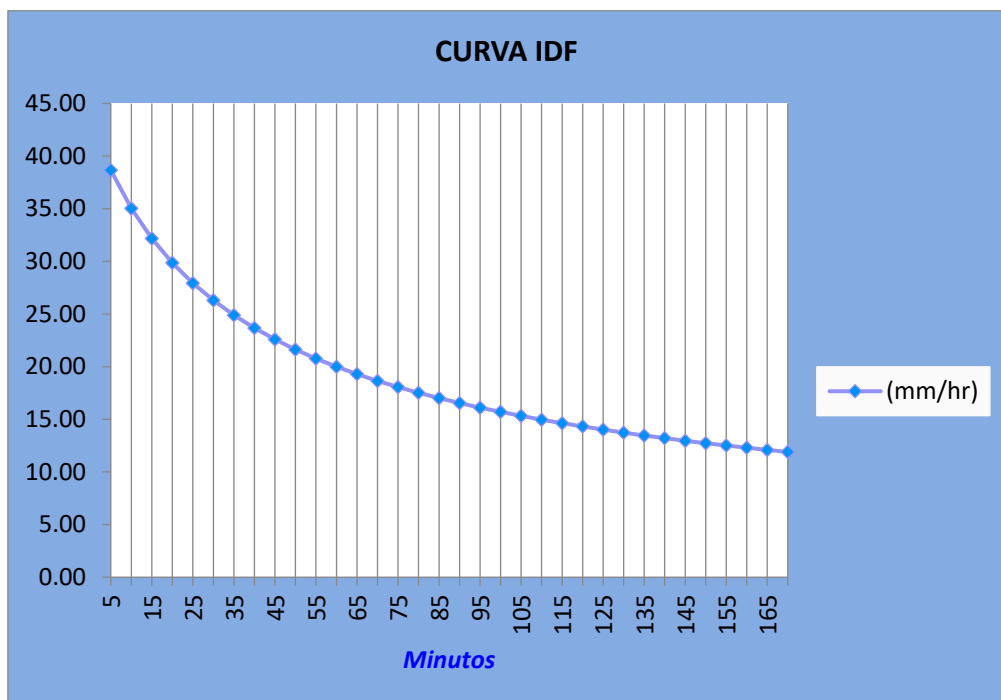
Tabla 95: Datos de las Subcuencas

4.4.4.1. Crear "New Project"

- Procedemos a crear un proyecto nuevo y lo nombraremos como "Cuenca Chicama".



Ilustración 42: Crear "New Project"

4.4.4.2. Crear "Basin Model"

- Procedemos a crear un componente "Basin Model".

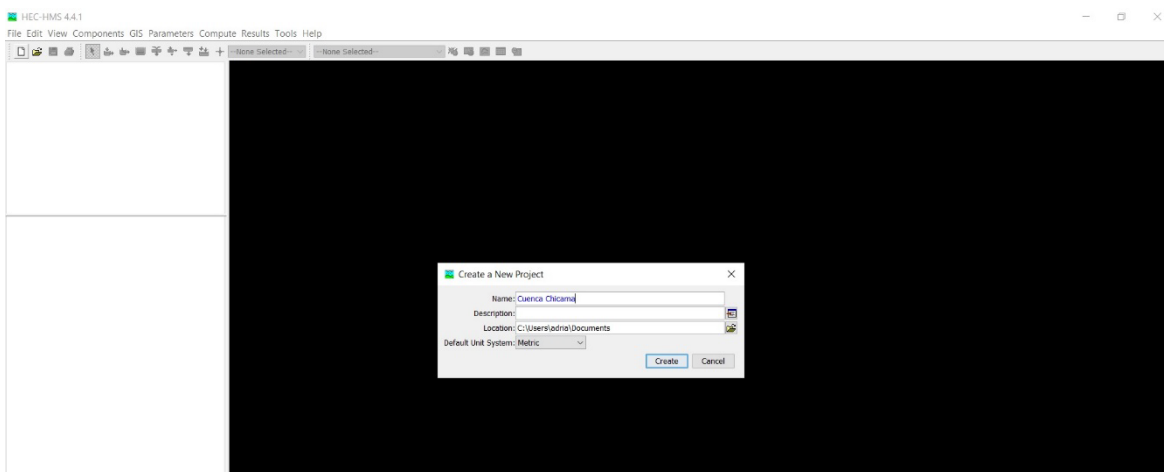

Ilustración 43: Crear "Basin Model"

- “Basin Model” creado.

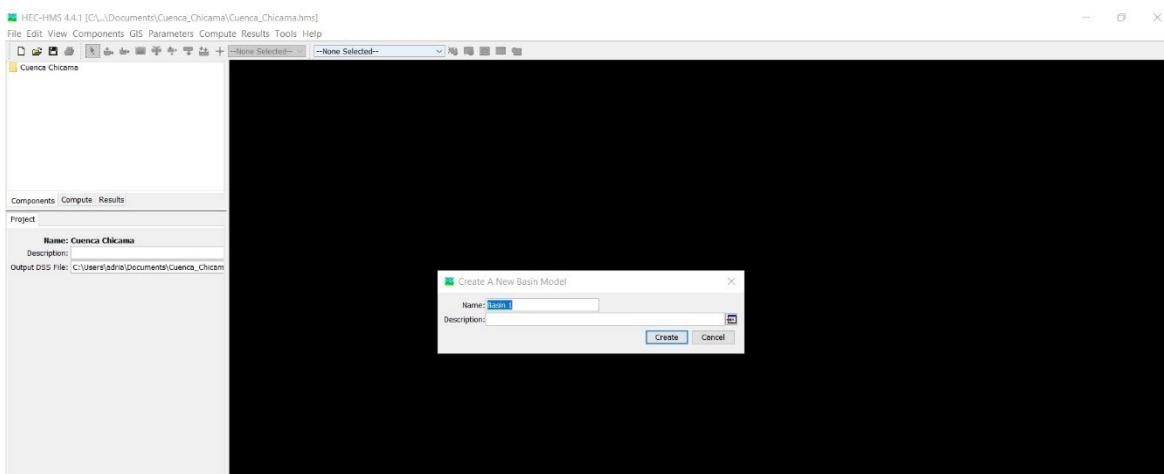

Ilustración 44: "Basin Model" creado.

- Procedemos a crear una “New Subbasin” dentro del componente “Basin Model”.

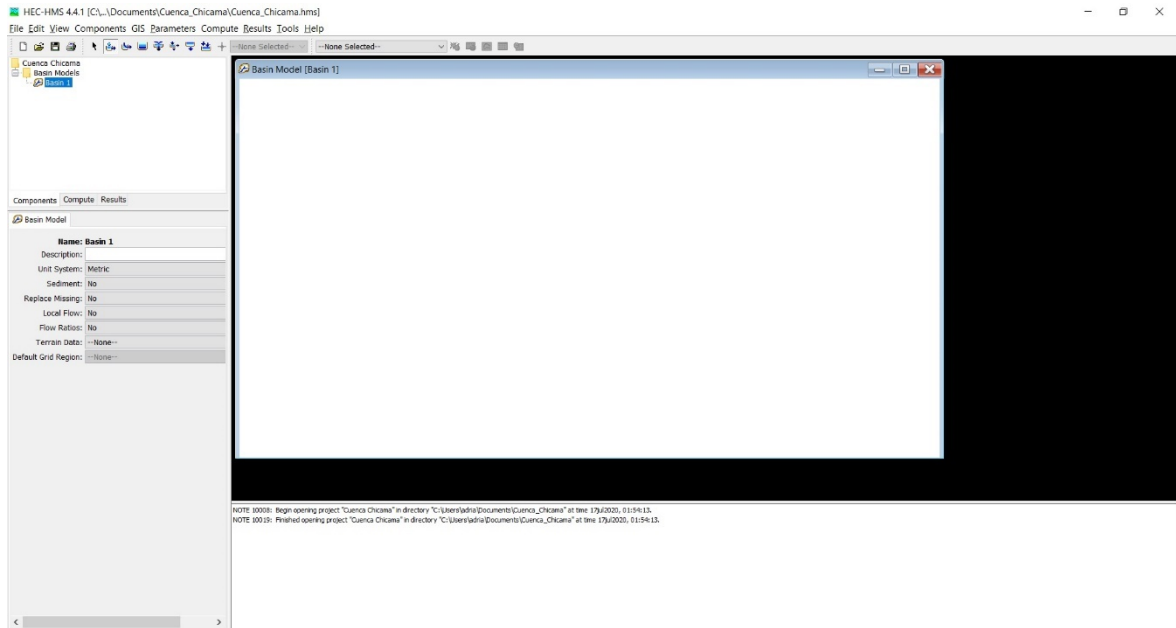

Ilustración 45: Crear "New Subbasin"

- “Subbasin Model” creado.

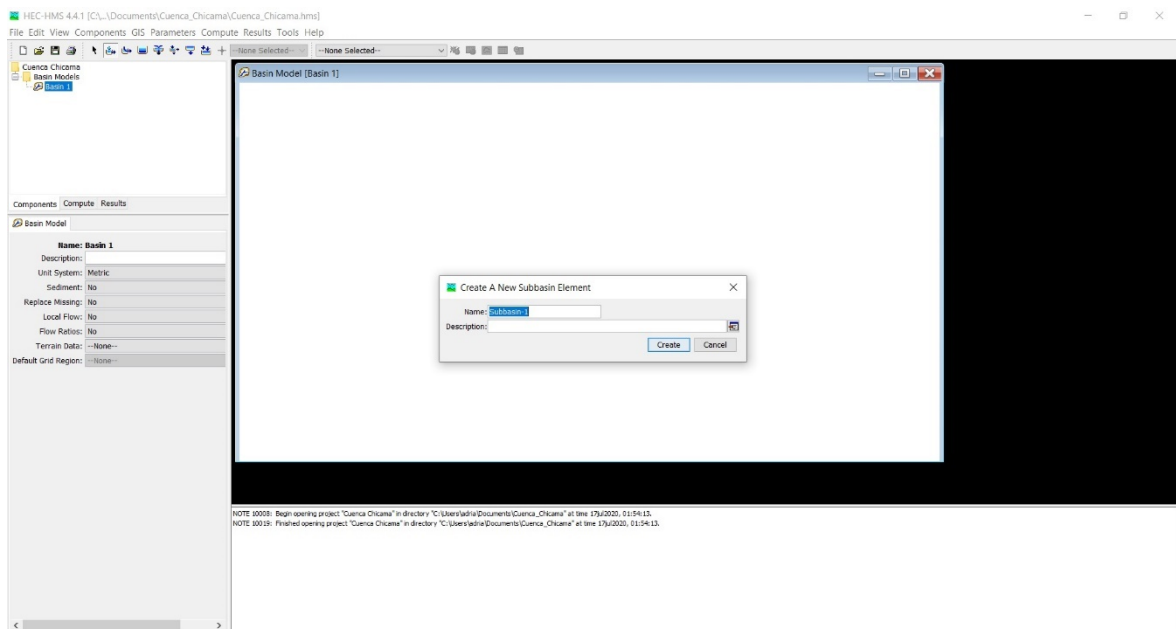

Ilustración 46: "Subbasin" creado

- Completamos los elementos de “Subbasin-1” con los siguientes datos:

Pestaña “Subbasin”:

- Area(Km2): 2338.98
- Canopy Method: None.
- Surface Method: None.
- Loss Method: SCS Curve Number.
- Transform Method: SCS Unit Hydrograph.
- Baseflow Method: None.

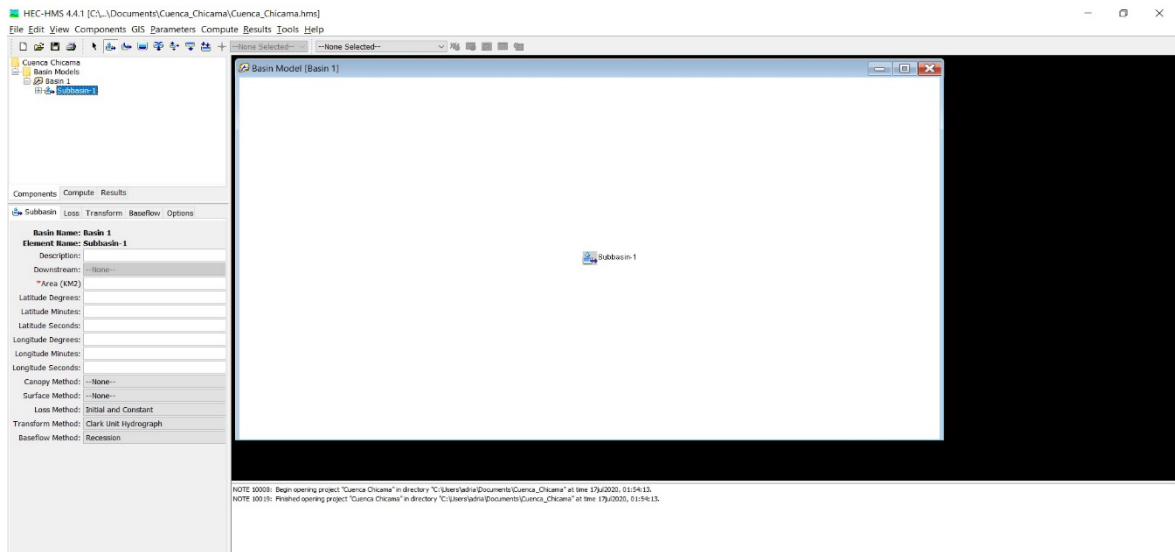

Ilustración 47: Rellenando los elementos de "Subbasin-1"

Pestaña "Loss":

- Curve Number: 71
- Impervious (%): 0.0

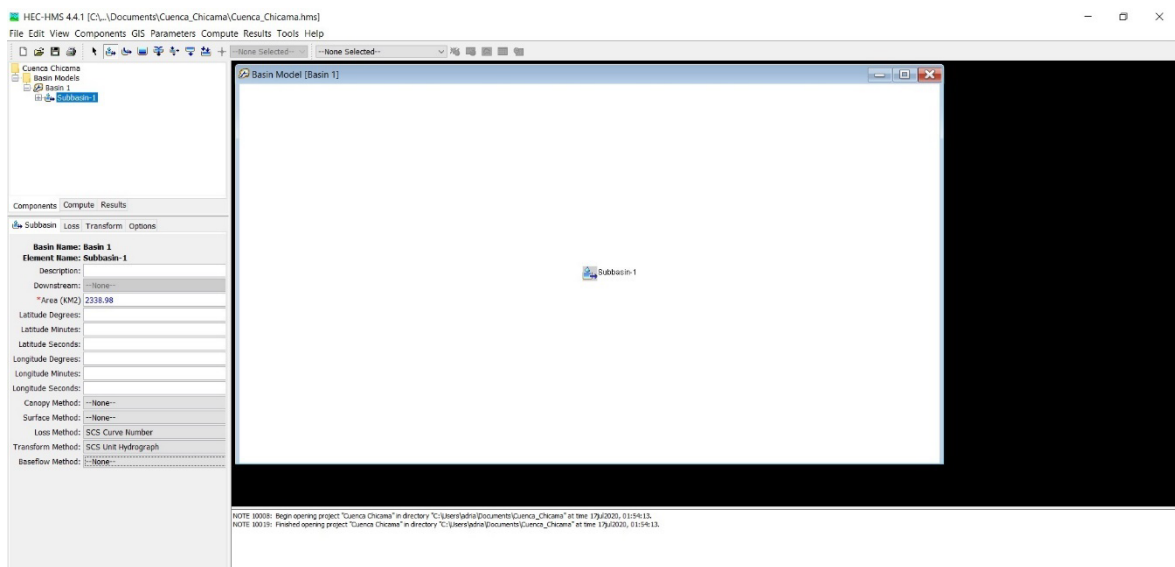

Ilustración 48: Rellenar los datos de la Pestaña "Loss"

Pestaña "Transform":

Para hallar el Lag Time(MIN) debemos de hacer algunos cálculos previos como el Tiempo de Concentración (Tc).

$$\text{Fórmula de Kirpich: } T_c = 0.06628 \frac{L^{0.77}}{S^{0.385}}$$

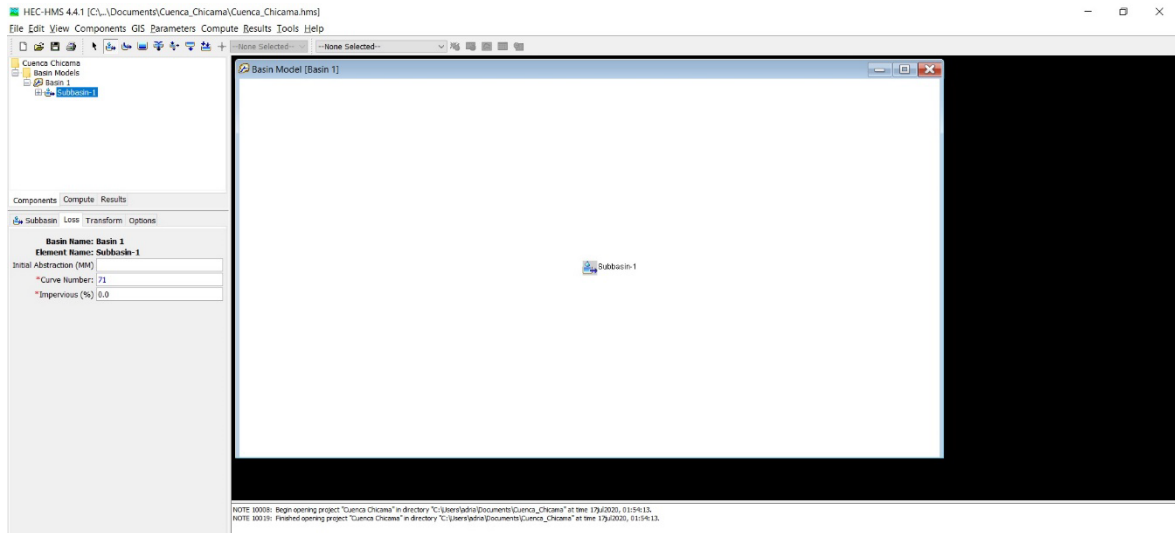
Dónde:

Tc: Tiempo de concentración en horas

L: Longitud en Km

S: Pendiente

$$T_c = 0.06628 * \frac{78.17876^{0.77}}{0.033^{0.385}}$$

$$T_c = 7.1048 \text{ horas}$$

$$\text{Lag Time(MIN)} = T_c * 0.6 * 60$$

$$\text{Lag Time(MIN)} = 255.77$$



Ilustración 49: Rellenar los datos de la Pestaña "Transform"

4.4.4.3. Crear "Meteorologic Models"

- Procedemos a crear un componente "Meteorologic Models".

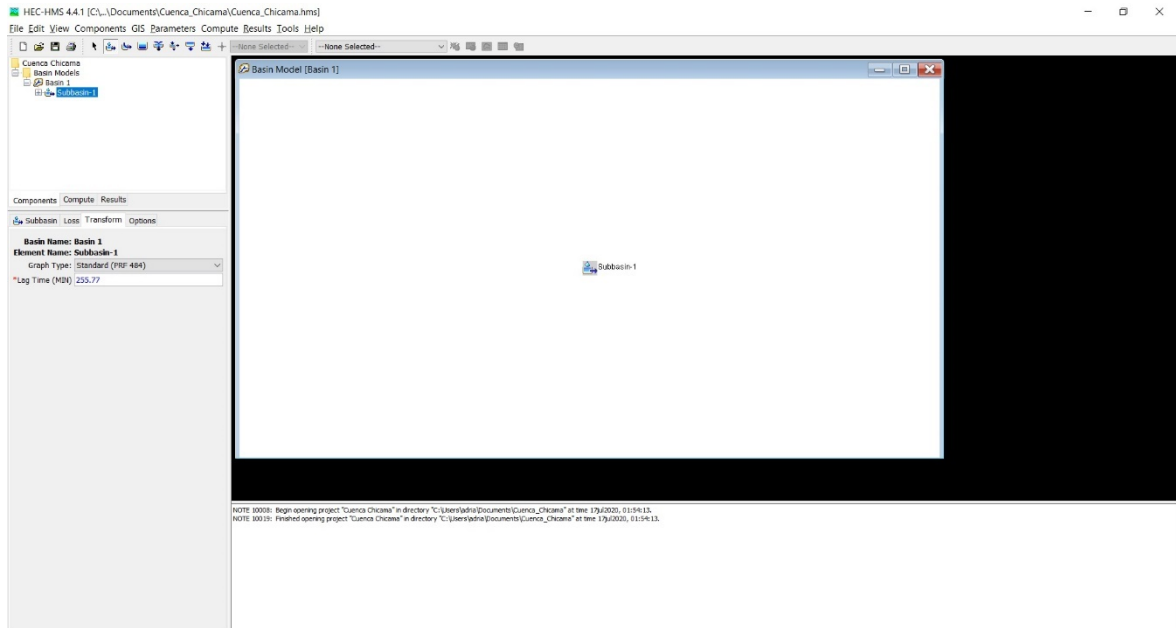

Ilustración 50: Crear "Meteorologic Models"

- “Meteorologic Models” creado.

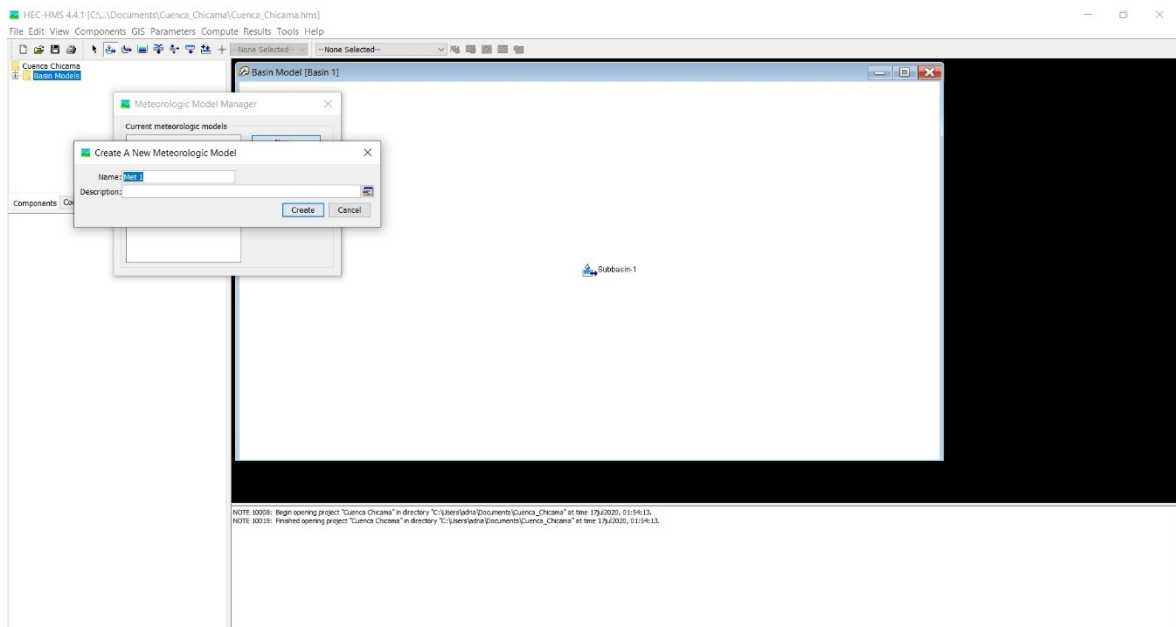

Ilustración 51: "Meteorologic Models" creado

- Completamos los elementos de “Met 1” con los siguientes datos:

Pestaña “Meteorology Model”:

- Replace Missing: Set To Default.

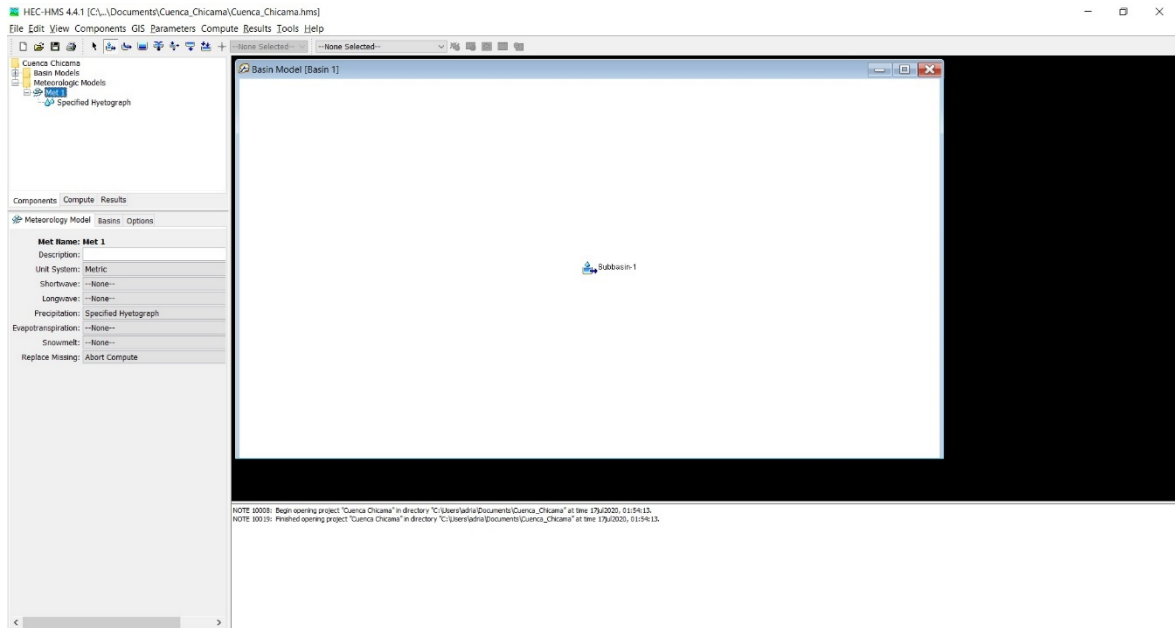

Ilustración 52: Rellenar los datos de la Pestaña "Meteorologic Models"

Pestaña “Basins”:

- Basin 1: Yes.

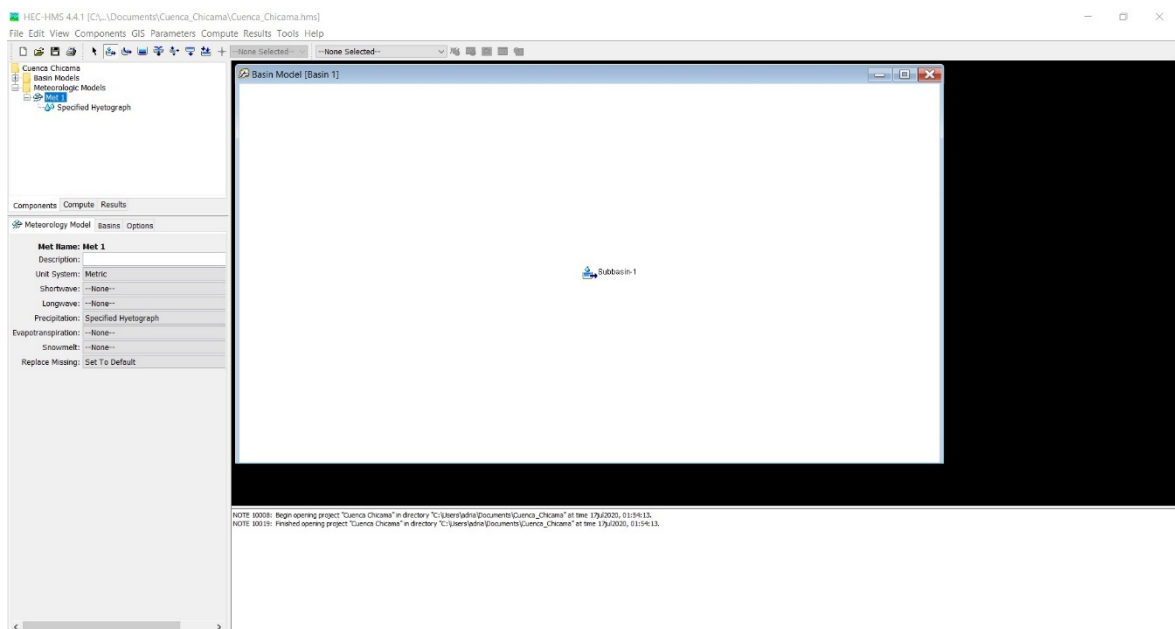

Ilustración 53: Rellenar los datos de la Pestaña "Basin 1"

Pestaña “Options”:

- Total Override: Yes.

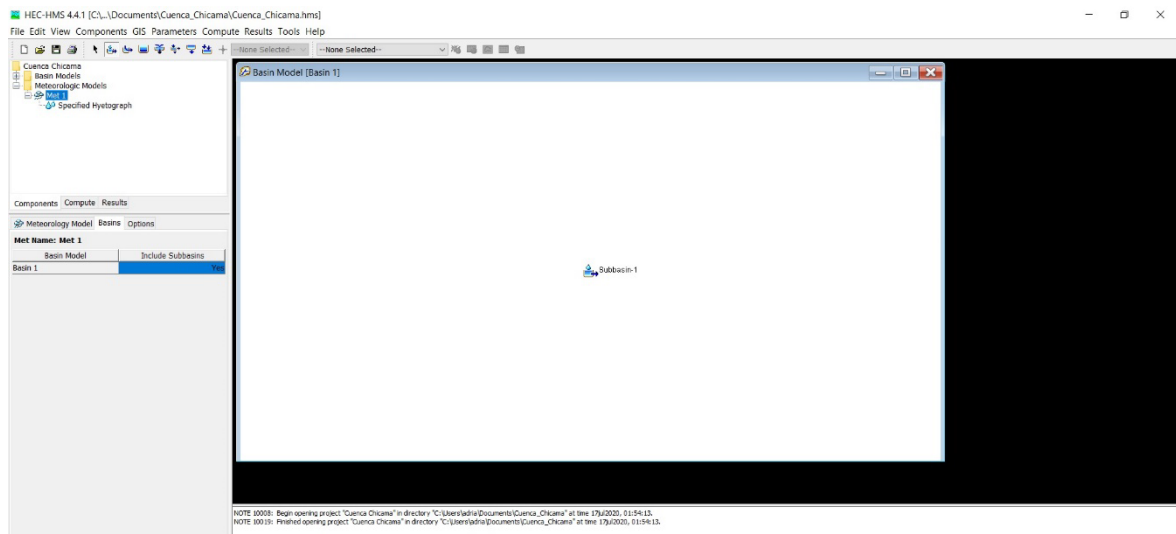

Ilustración 54: Rellenar los datos de la Pestaña "Options"

- Para completar los elementos de “Specified Hyetograph” necesitaremos el dato de “Total Depth (MM)” que podemos calcularlo con los datos mensuales de precipitación máxima en 24hrs(mm), pero para poder ingresarlo debemos haber creado antes una componente “Precipitation Gages”:

Distribución de probabilidades pluviométricas mediante Gumbel				
Nº	Año	Max. Precipitación Mensual (mm)	x_i	$(x_i - \bar{x})^2$
1	1964	26.70	26.70	78.93
2	1965	42.90	42.90	53.52
3	1966	25.20	25.20	107.84
4	1967	28.50	28.50	50.19
5	1968	40.00	40.00	19.50
6	1969	49.30	49.30	188.12
7	1970	30.20	30.20	28.99
8	1971	27.10	27.10	71.98
9	1972	36.00	36.00	0.17
10	1973	27.40	27.40	66.98
11	1974	48.00	48.00	154.15
12	1975	39.50	39.50	15.33
13	1976	27.00	27.00	73.69
14	1977	40.00	40.00	19.50
15	1978	21.50	21.50	198.37
16	1979	39.90	39.90	18.62
17	1980	46.00	46.00	108.49
18	1981	30.80	30.80	22.89
19	1982	49.10	49.10	182.67
20	1983	38.20	38.20	6.84
21	1984	36.50	36.50	0.84
22	1985	30.60	30.60	24.84
23	1986	27.00	27.00	73.69
24	1987	37.50	37.50	3.67
25	1988	24.20	24.20	129.60
26	1989	36.20	36.20	0.38
27	1990	33.50	33.50	4.34
28	1991	25.78	25.78	96.07
29	1992	25.78	25.78	96.07
30	1993	30.50	30.50	25.85
31	1994	52.20	52.20	276.08
32	1995	39.20	39.20	13.07
33	1996	34.70	34.70	0.78
34	1997	35.10	35.10	0.23
35	1998	35.70	35.70	0.01
36	1999	49.40	49.40	190.87
37	2000	32.10	32.10	12.14
38	2001	34.00	34.00	2.51
39	2002	31.20	31.20	19.22
40	2003	24.80	24.80	116.30
41	2004	43.30	43.30	59.53
42	2005	43.10	43.10	56.48
43	2006	51.10	51.10	240.73
44	2007	38.90	38.90	10.99
45	2008	28.00	28.00	57.52
46	2009	31.50	31.50	16.68
47	2010	47.30	47.30	137.26
		Suma	1672.47	3132.57

Tabla 96: Distribución de probabilidades pluviométricas mediante Gumbel

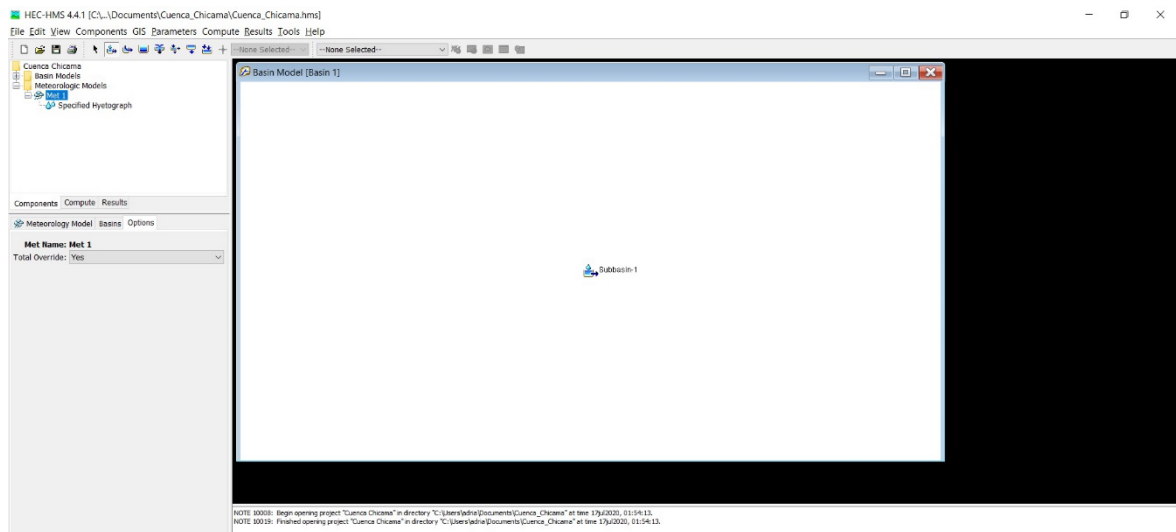
Cálculo Variable Probabilísticas			
	$\bar{x} = \frac{\sum x_i}{n} =$	35.58	mm
	$S = \sqrt{\frac{\sum_{i=1}^n (x_i - \bar{x})^2}{n - 1}} =$	8.25	mm
	$\alpha = \frac{\sqrt{6}}{\pi} * S =$	6.43	mm
	$u = \bar{x} - 0.5772 * \alpha =$	31.87	mm

Tabla 97: Cálculo de Variable Probabilísticas

Fórmulas para el cálculo de las Precipitaciones Diarias Máximas Probables para distintas frecuencias			
	$A = Y_{(T)} = - \ln(\ln(\frac{T}{T-1}))$		
	$B = X_{(T)} = u + (\alpha \cdot A)$		
	$C = F_{(X_{T'})} = e^{-e^{-\frac{B \cdot u}{\alpha}}}$		
	$D = X_{(T)} = 1.13 B$		

Tabla 98: Fórmulas para el cálculo de las Precipitaciones Diarias máximas probables para distintas frecuencias

Cálculo de las Precipitaciones Diarias Máximas Probables para distintas frecuencias				
Periodo Retorno	Variable Reducida	Precip. (mm)	Prob. de ocurrencia	Corrección intervalo fijo
Años	YT	XT'(mm)	F(XT')	XT (mm)
2	0.3665	34.2288	0.5000	38.6785
5	1.4999	41.5215	0.8000	46.9193
10	2.2504	46.3499	0.9000	52.3754
25	3.1985	52.4507	0.9600	59.2693
50	3.9019	56.9765	0.9800	64.3835
100	4.6001	61.4690	0.9900	69.4600
500	6.2136	71.8504	0.9980	81.1909

Tabla 99: cálculo de las Precipitaciones Diarias máximas probables para distintas frecuencias.

Obteniendo un “Total Depth” = 69.46 mm, dato que ingresaremos más adelante.

4.4.4.4. Crear “Control Specifications”

- Procedemos a crear un componente “Control Specifications”.



Ilustración 55: Crear "Control Specifications"

- “Control Specifications” creado.

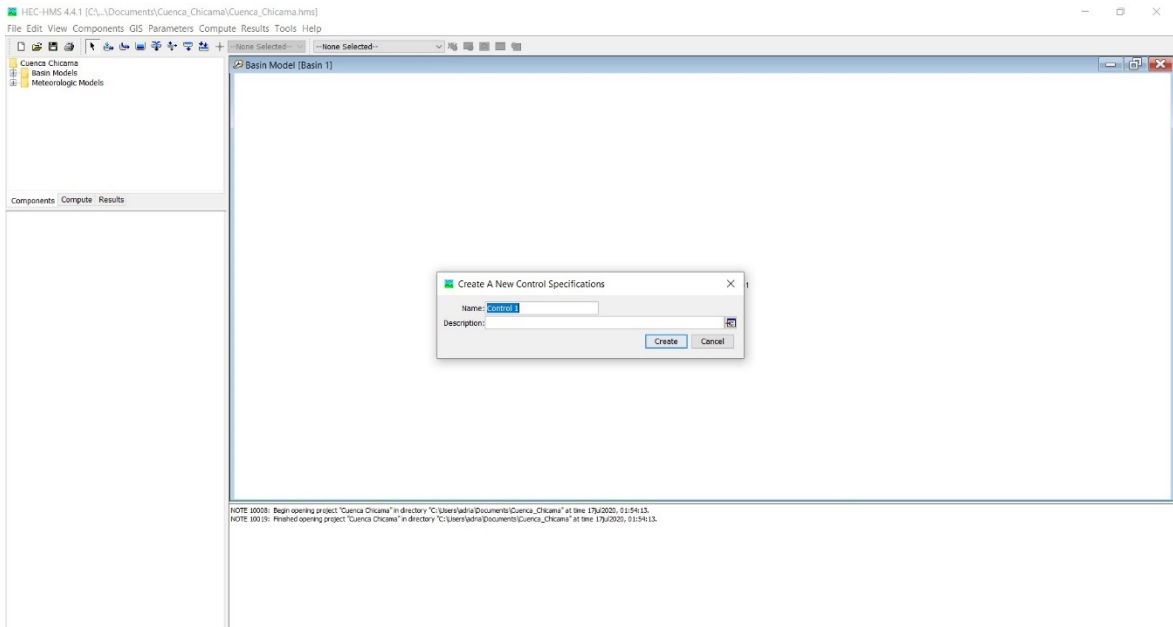

Ilustración 56: "Control Specifications" creado

- Completamos los elementos de “Control 1” con los siguientes datos:

Pestaña “Control Specifications”:

- Start Date (ddMMMYYYY): 01jul2020
- Start Time (HH:mm): 00:00
- End Date (ddMMMYYYY): 02jul2020
- End Time (HH:mm): 05:00
- Time Interval: 1 Hour

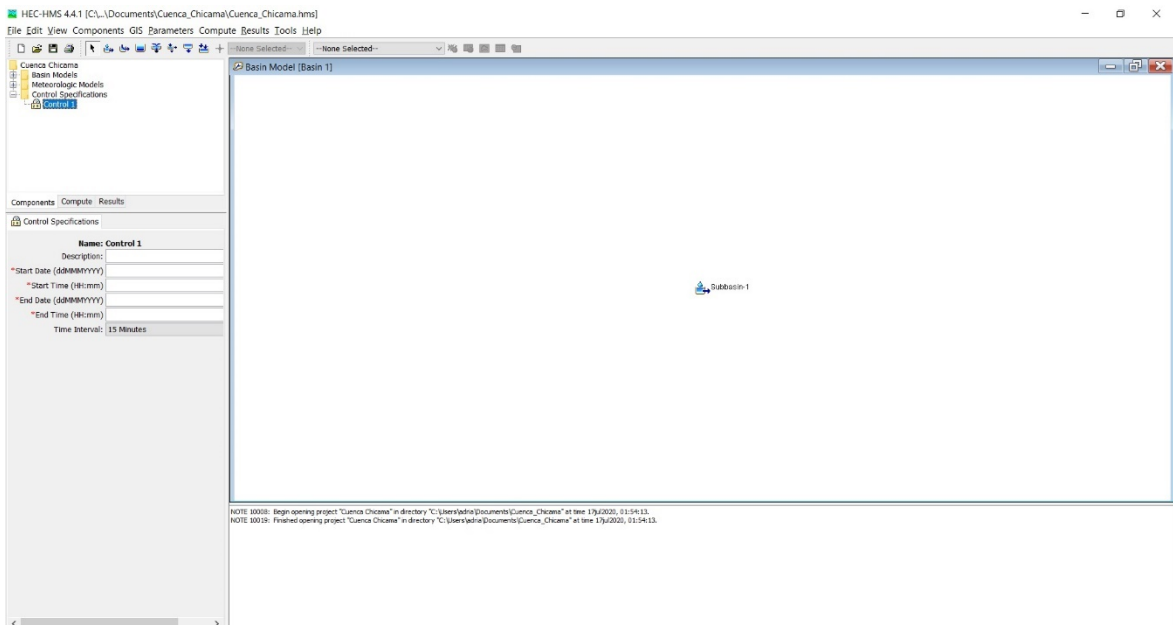

Ilustración 57: Rellenar con los datos los elementos de "Control 1"

4.4.4.5. Crear “Time - Series Data”

- Procedemos a crear un componente “Time – Series Data”.

- Name: Lluvia
- Data Type: Precipitation Gages

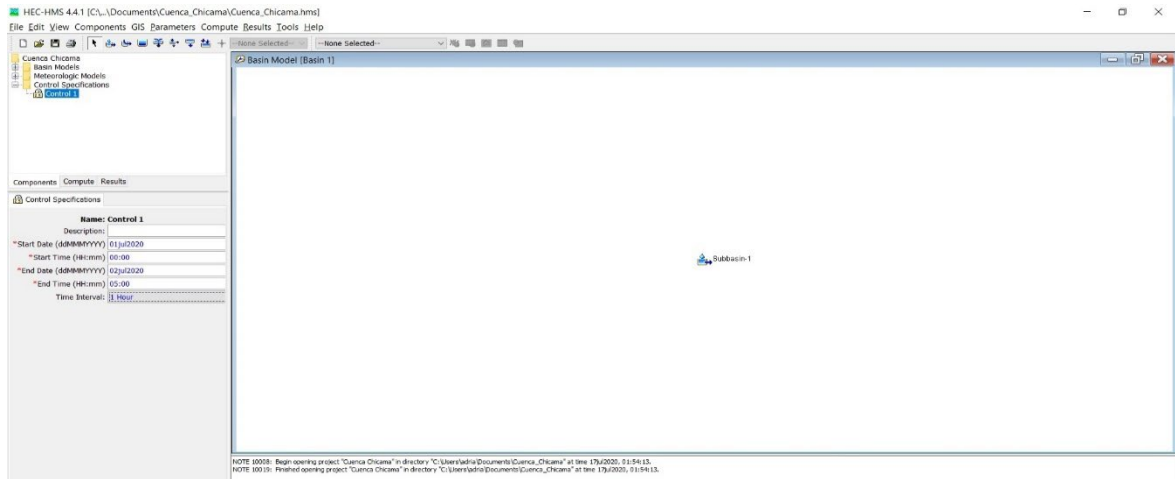

Ilustración 58: Crear "Time - Series Data"

- "Time – Series Data" creado.

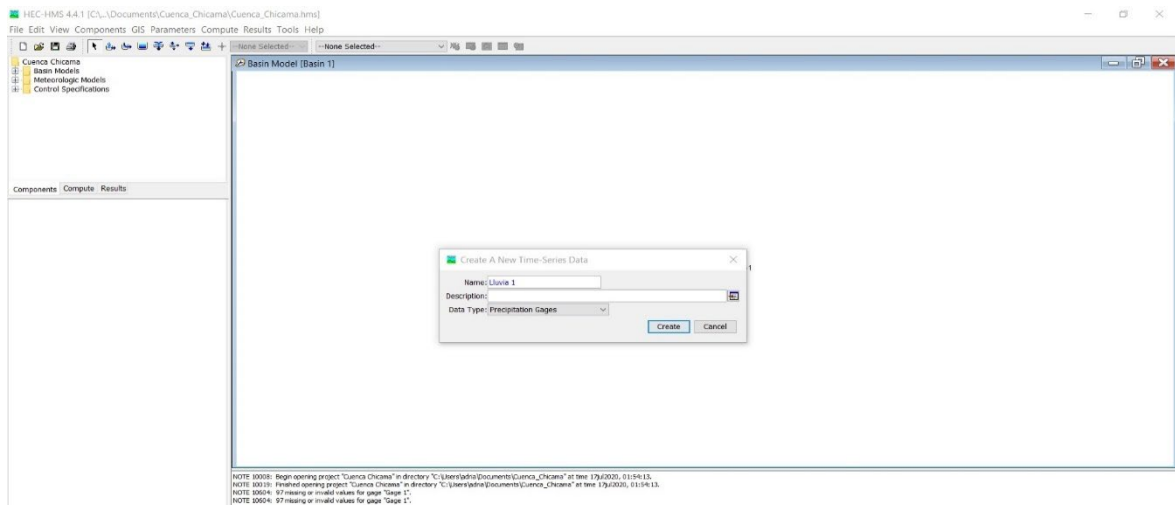

Ilustración 59: "Time - Series Data" creado

- Completamos los elementos de "Lluvia 1" con los siguientes datos:

Pestaña "Time – Series Gage":

- Time Interval: 5 Minutes

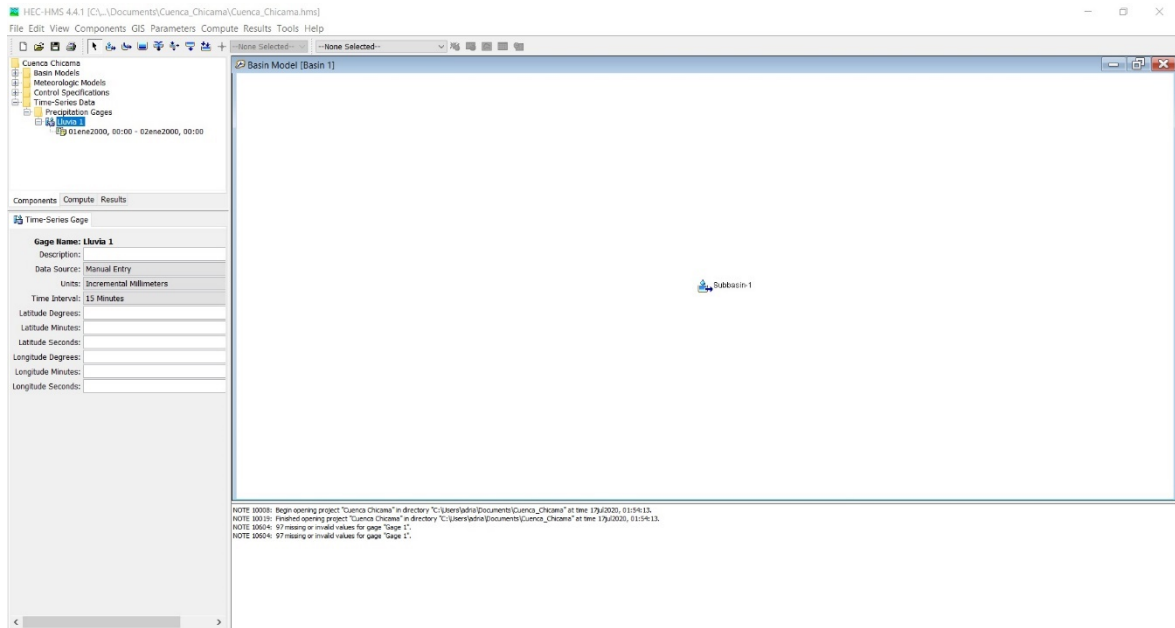

Ilustración 60: Rellenar los datos de la Pestaña "Time - Series Gage"

Pestaña "Time Window":

- Start Date (ddMMMYYYY): 01jul2020
- Start Time (HH:mm): 00:00
- End Date (ddMMMYYYY): 01jul2020
- End Time (HH:mm): 02:50

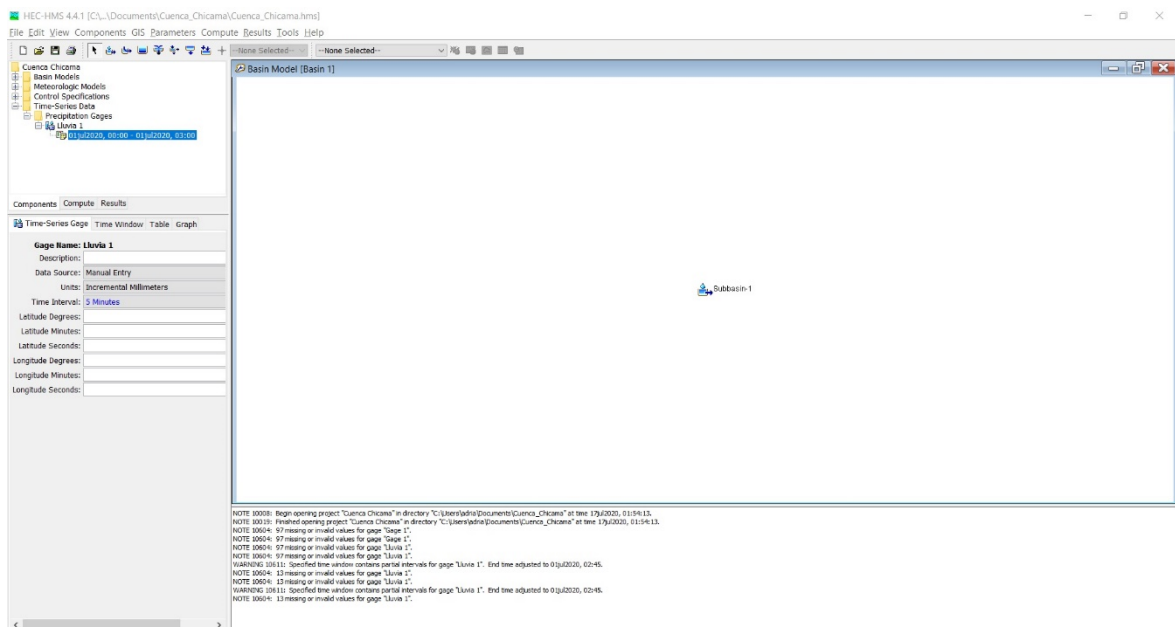

Ilustración 61: Rellenar los datos de la Pestaña "Time Window"

Pestaña "Table":

Aquí es dónde debemos ingresar las precipitaciones obtenidas por medio del software Hydroiila, que ya tenemos calculados en el apartado 4.4.3.6.

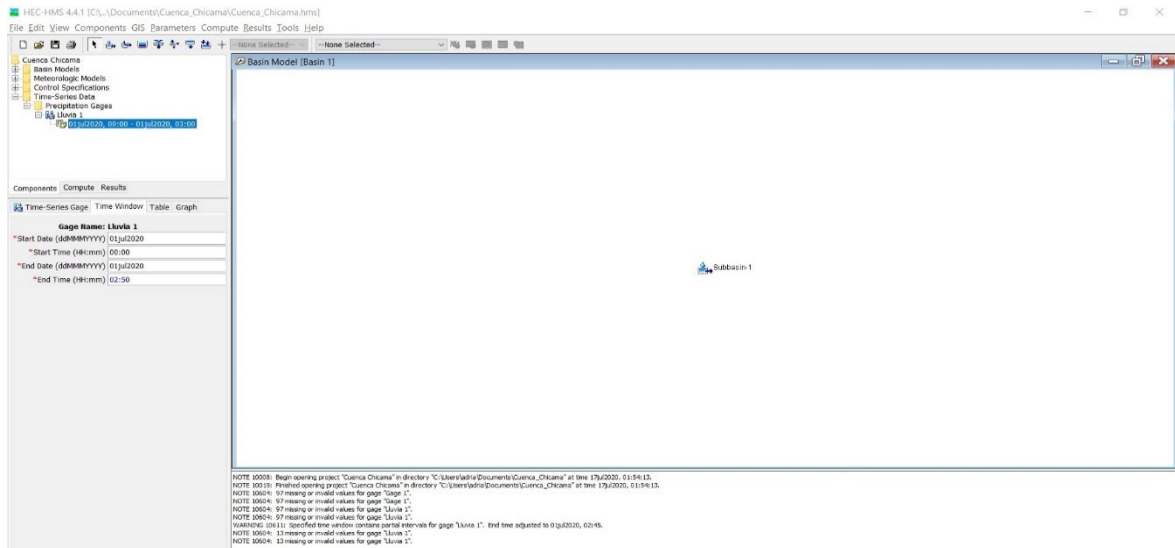

Ilustración 62: Rellenar los datos de la Pestaña "Table"

4.4.4.6. Total Depth

- Completamos el dato que faltaba ingresar en “Specified Hyetograph” con los siguientes datos:

Pestaña “Specified Hyetograph”:

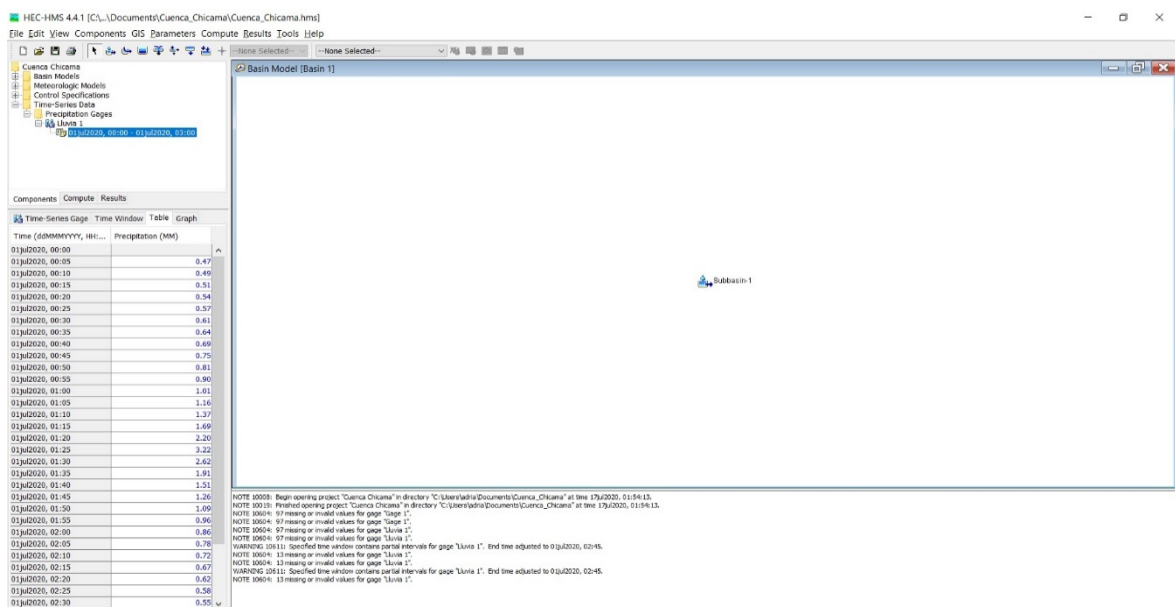
- Subbasin-1: Lluvia 1 - 69.46



Ilustración 63: Rellenar los datos de la Pestaña "Specified Hyetograph"

4.4.4.7. Simulación

- Para realizar la simulación y obtener los resultados, seleccionamos nuestro ícono de “subbasin-1” en la pantalla de diseño, nos dirigimos a “Compute”, luego a “Create Compute” y finalmente hacemos clic en “Simulation Run”.

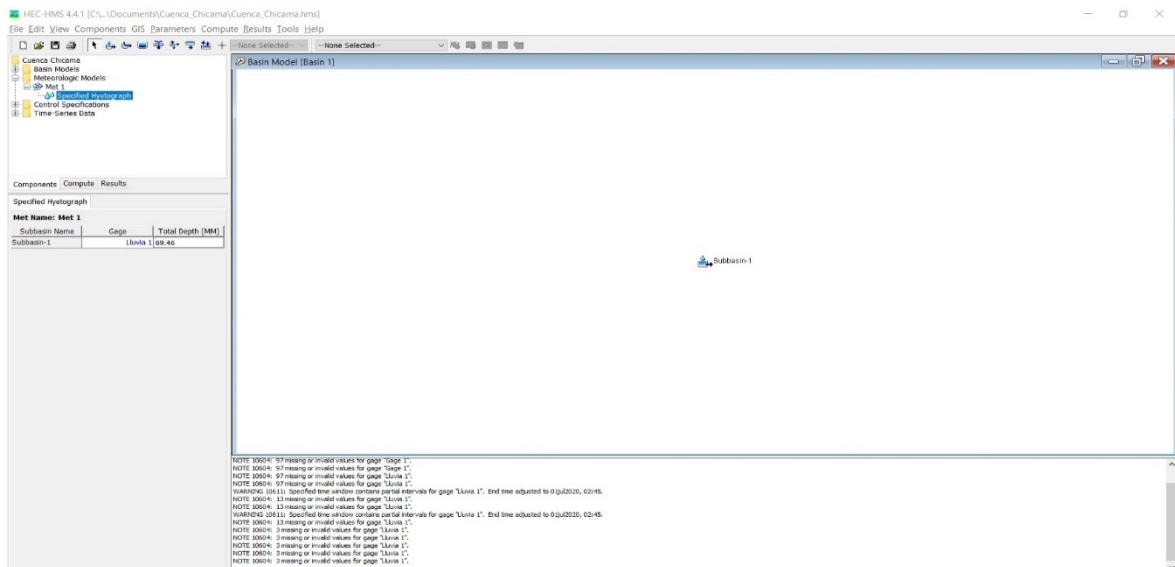

Ilustración 64: Crear la simulación

- Debemos colocarle un nombre a la simulación o dejarla como aparece por defecto "Run 1" y dar clic en siguiente.

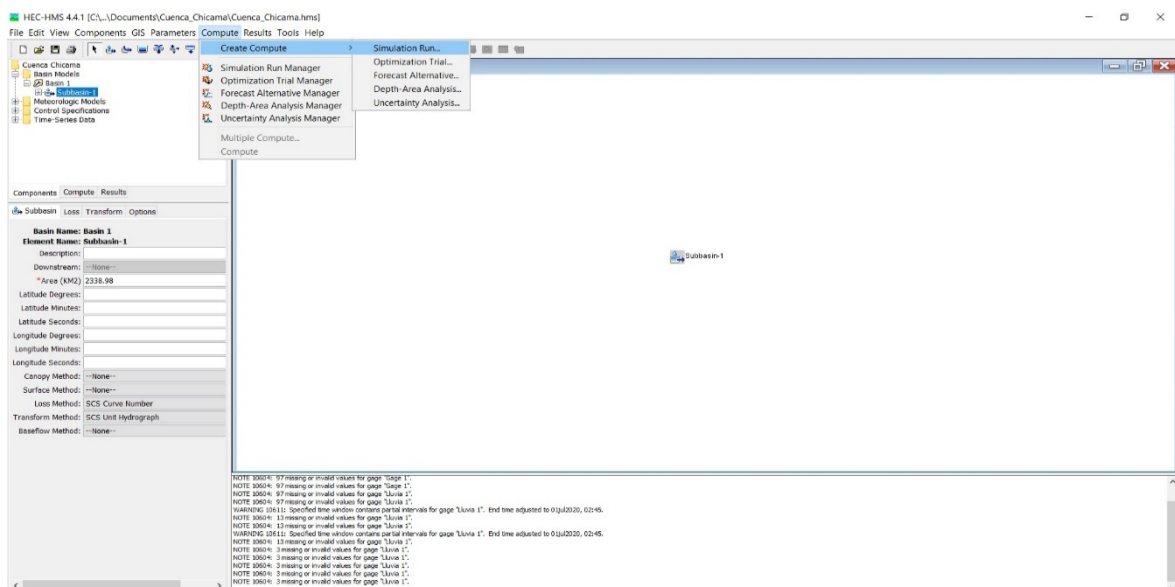

Ilustración 65: Nombre para la simulación

- Debemos seleccionar "Basin 1" y dar clic en siguiente.

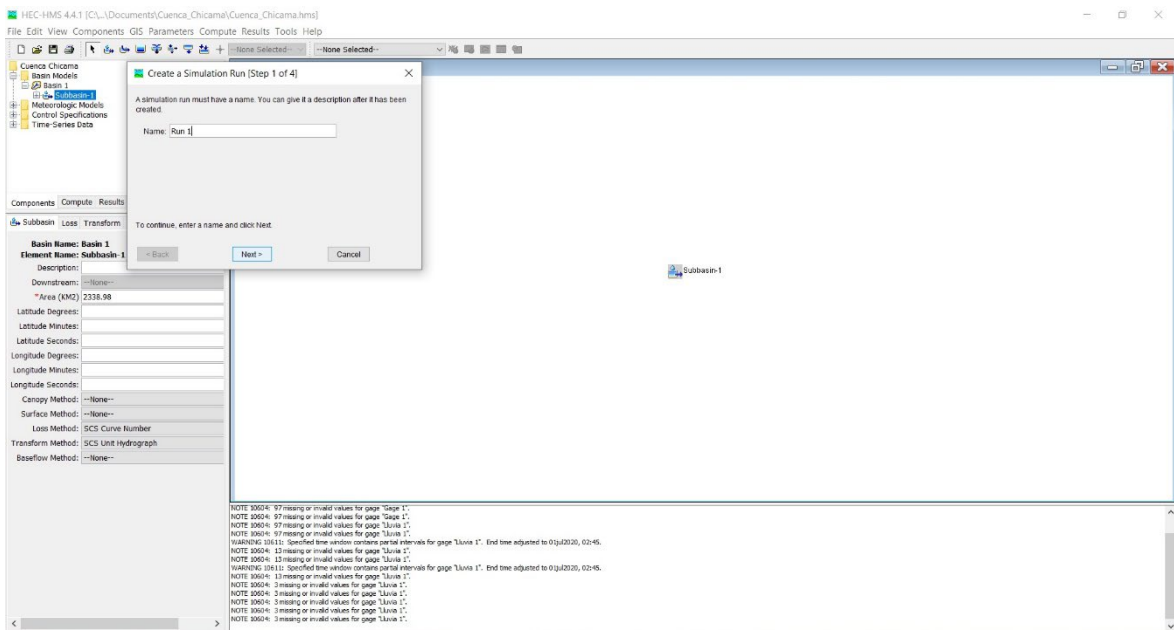

Ilustración 66: Seleccionar "Basin 1" para la Simulación

- Debemos seleccionar "Met 1" y dar clic en siguiente.

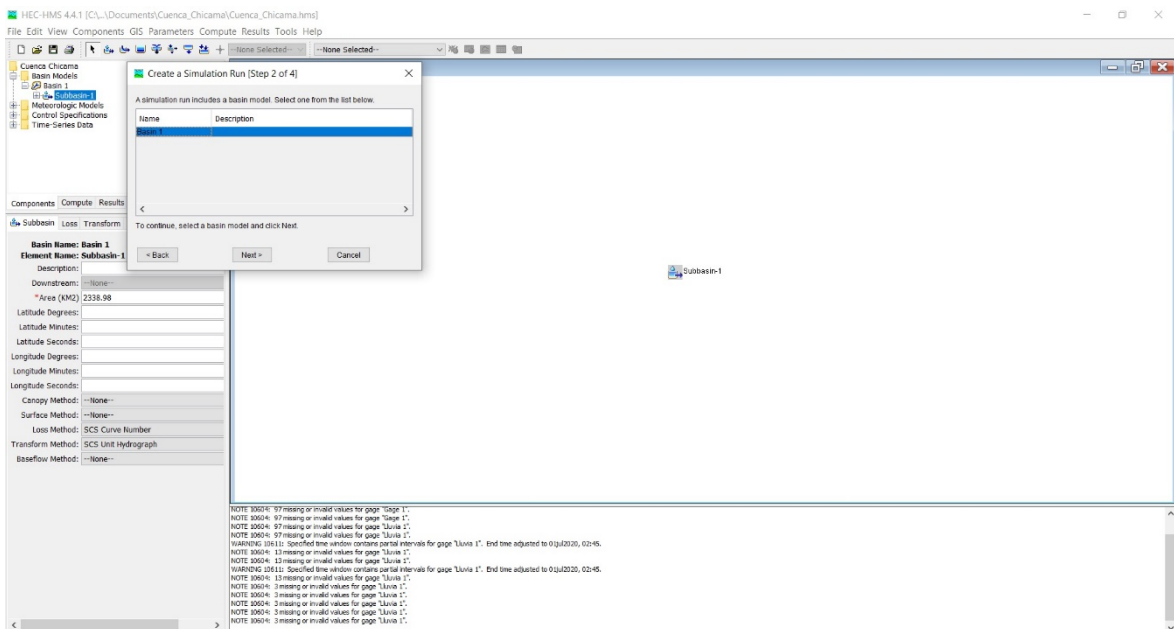

Ilustración 67: Seleccionar "Met 1" para la Simulación

- Debemos seleccionar "Control 1" y dar clic en finalizar.

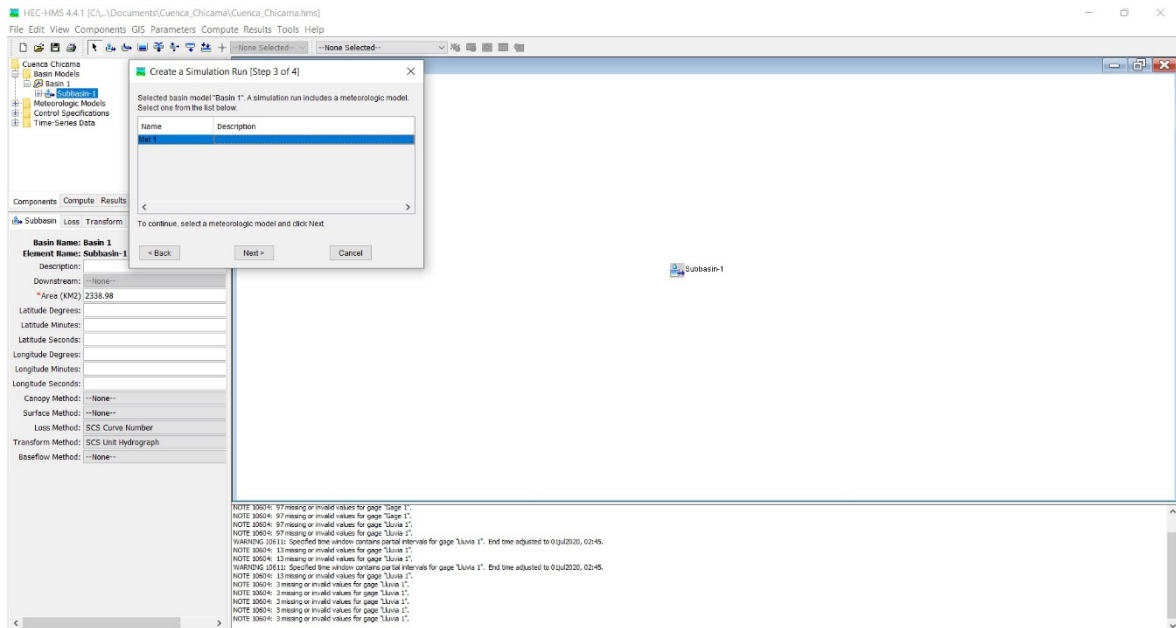

Ilustración 68: Seleccionar "Control 1" para la Simulación

- Creada la simulación, debemos ejecutarla, para esto debemos ir a la pestaña tal y como se muestra en pantalla y seleccionar “Run 1” o en su defecto el nombre que le hayamos dado a la simulación.

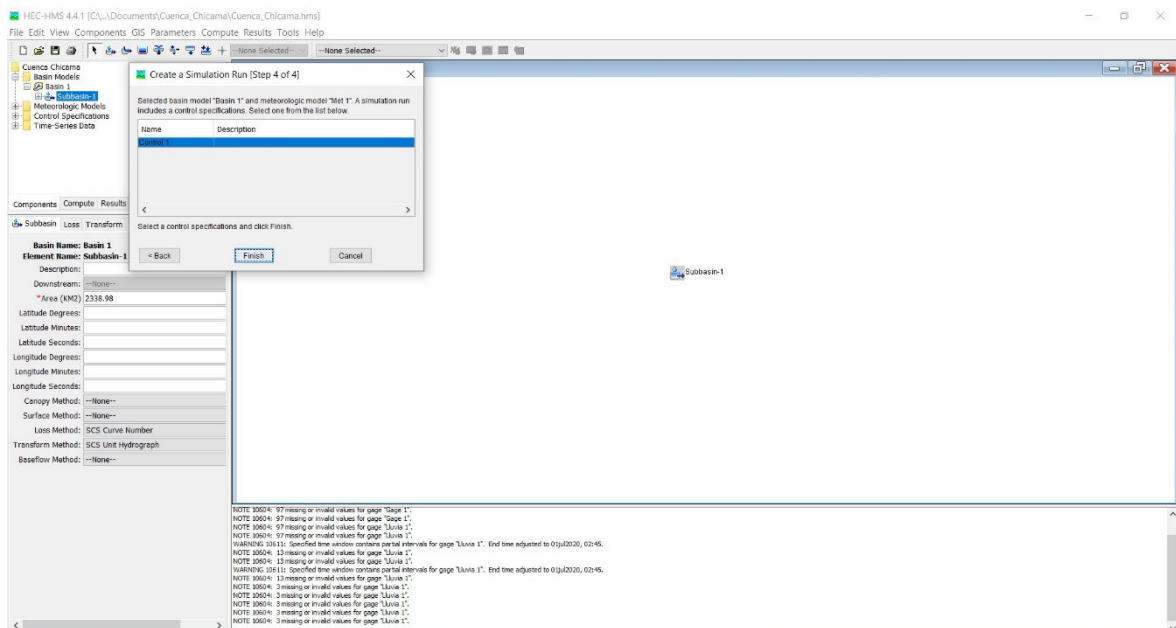

Ilustración 69: Ejecutar la simulación

- El ícono de “Compute All Elements” se activará, y al darle clic, ejecutará nuestra simulación.



“Compute All Elements”

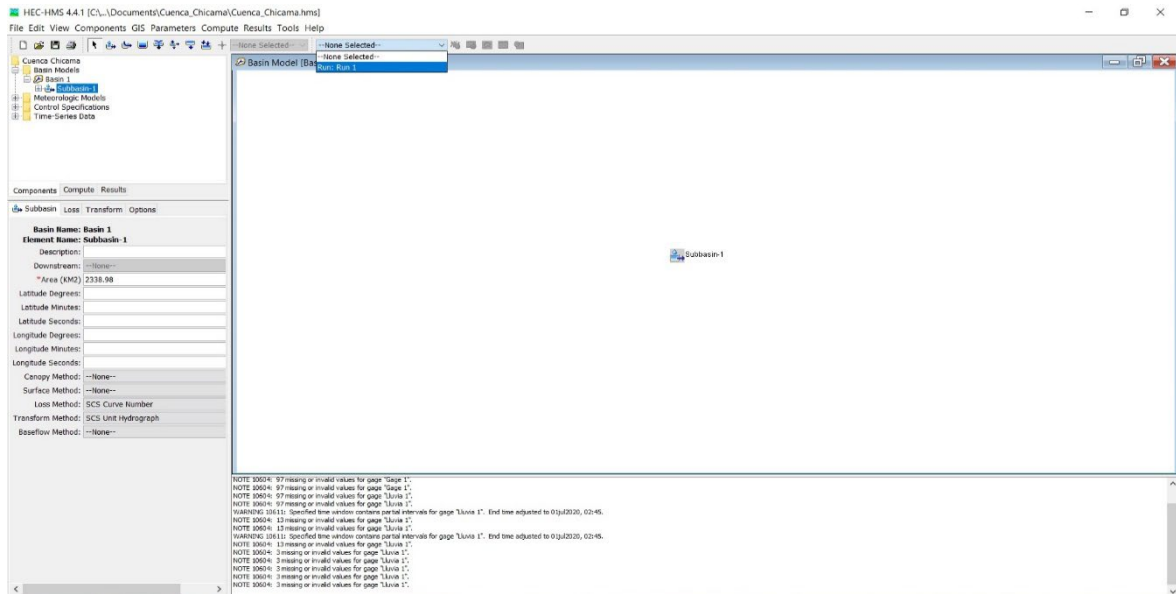
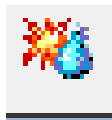

Ilustración 70: Activación del ícono "Compute All Elements"

- Aparecerá una ventana en la cual se observará el progreso de la simulación, esperamos a que termine la simulación y hacemos clic en “Close”.

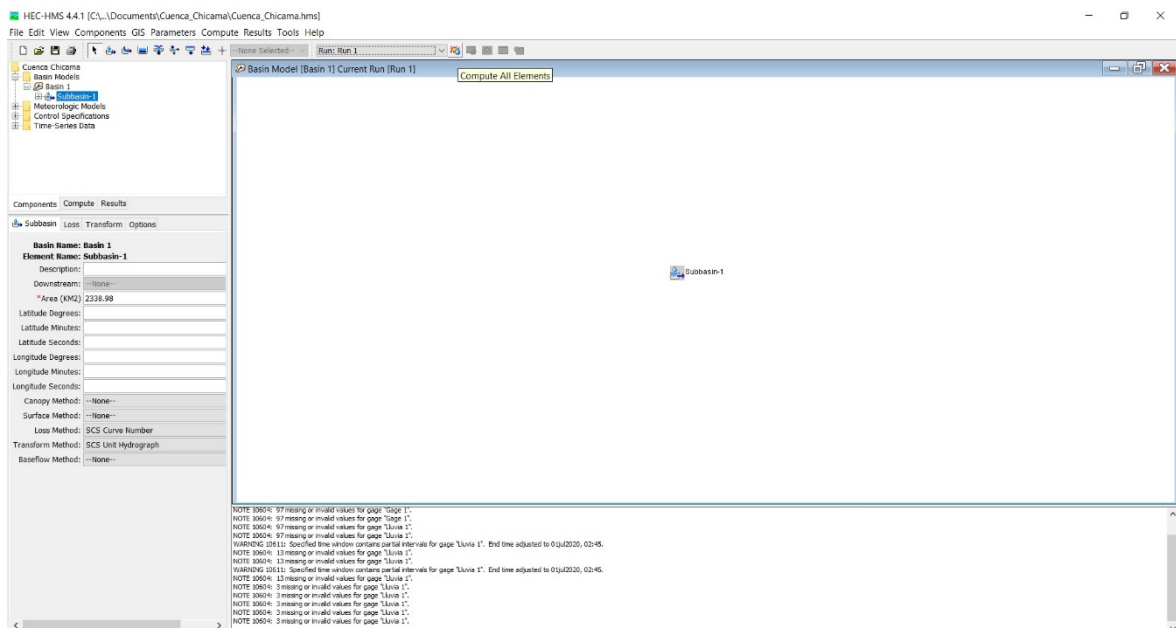

Ilustración 71: Progreso de la simulación

- Culminada la simulación se activarán 4 iconos en la barra de herramientas.



El primer ícono es “View Global Summary Table” y nos mostrará la siguiente ventana.

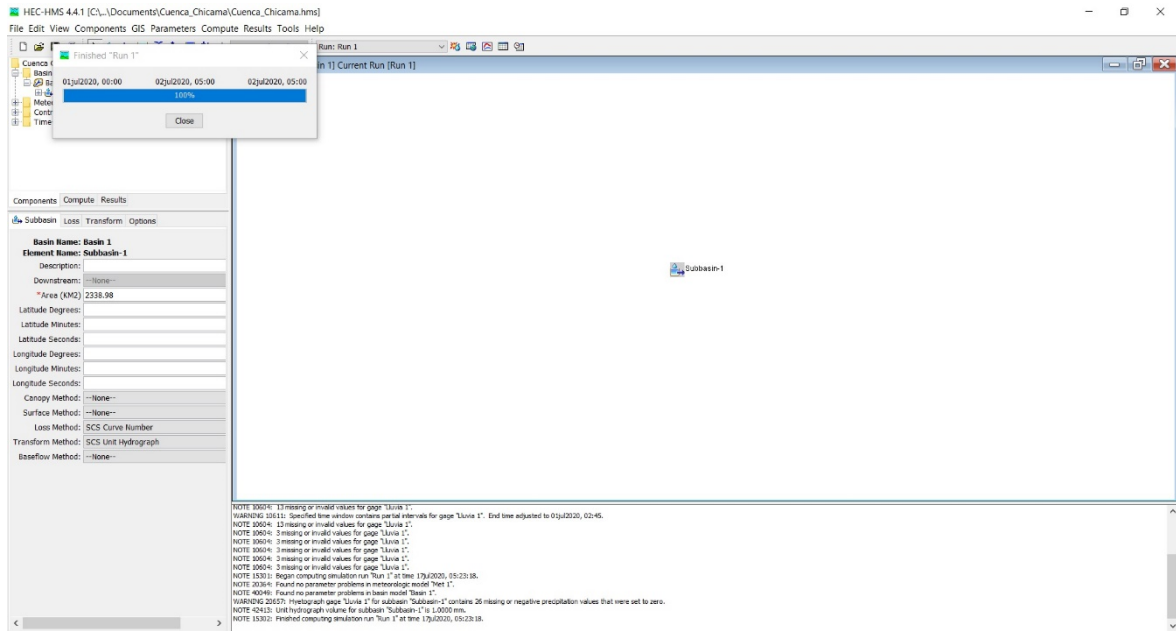
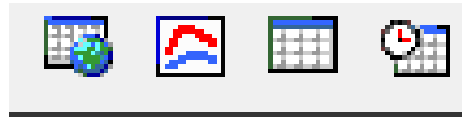

Ilustración 72: "View Global Summary Table"

El segundo ícono es "View Graph for Select Elements" y nos mostrará la siguiente ventana.

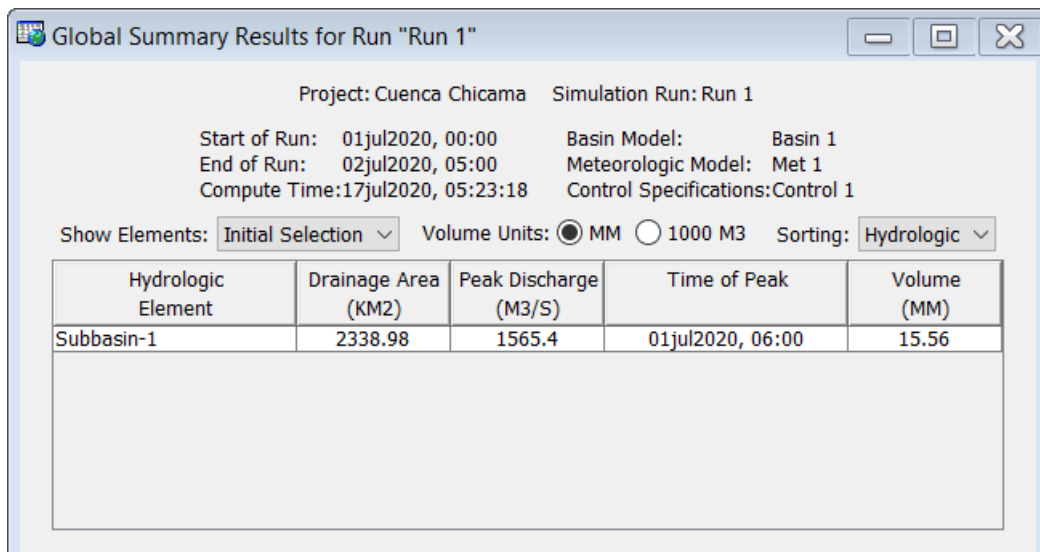

Ilustración 73: "View Graph for Select Elements"

El tercer ícono es "View Summary Table for Select Elements" y nos mostrará la siguiente ventana.

Summary Results for Subbasin "Subbasin-1"			
Project: Cuenca Chicama		Simulation Run: Run 1	
Subbasin: Subbasin-1			
Start of Run:	01jul2020, 00:00	Basin Model:	Basin 1
End of Run:	02jul2020, 05:00	Meteorologic Model:	Met 1
Compute Time:	17jul2020, 05:23:18	Control Specifications:	Control 1
Volume Units: <input checked="" type="radio"/> MM <input type="radio"/> 1000 M3			
Computed Results			
Peak Discharge:	1565.4 (M3/S)	Date/Time of Peak Discharge:	01jul2020, 06:00
Precipitation Volume:	69.46 (MM)	Direct Runoff Volume:	15.56 (MM)
Loss Volume:	53.90 (MM)	Baseflow Volume:	0.00 (MM)
Excess Volume:	15.56 (MM)	Discharge Volume:	15.56 (MM)

Ilustración 74: "View Summary Table for Select Elements"

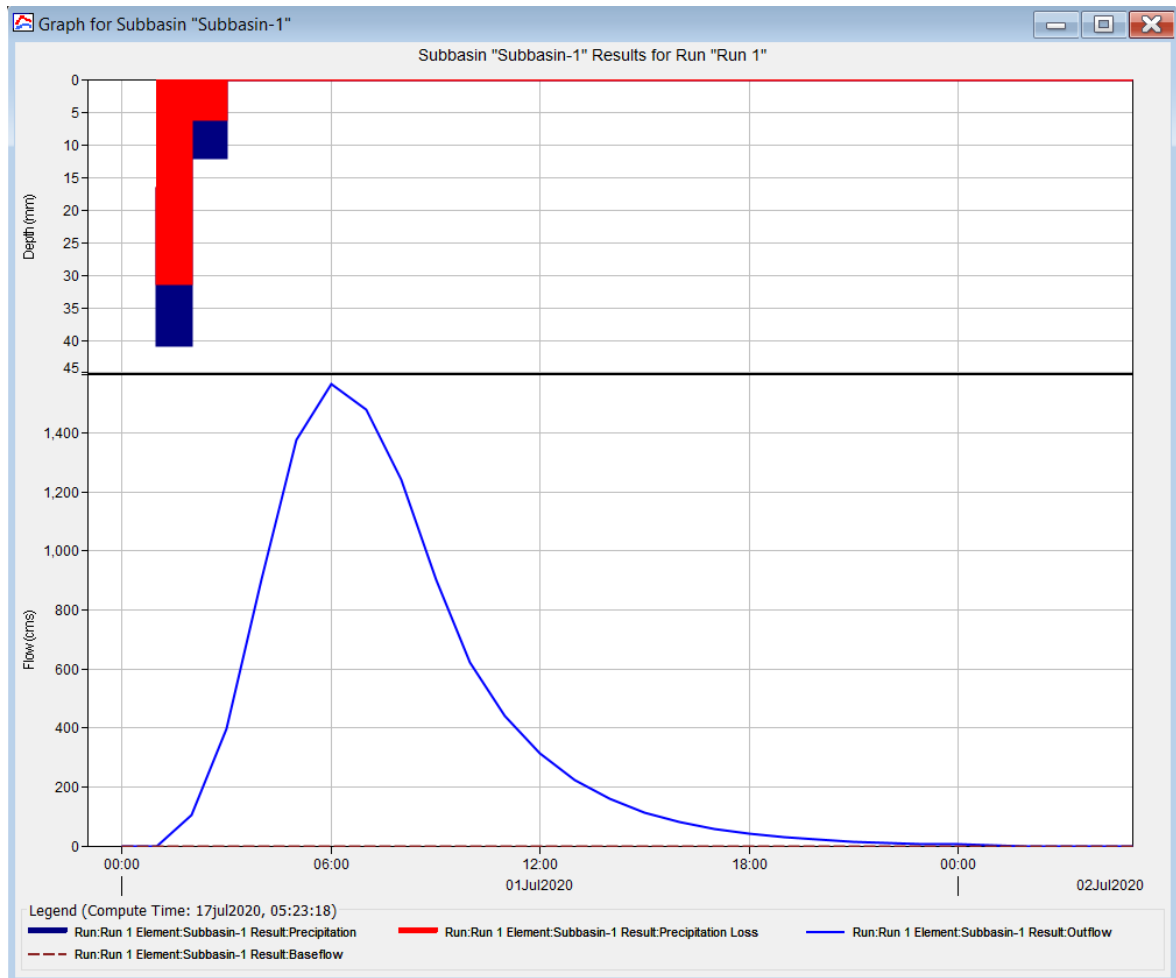
El cuarto ícono es “View Time – Series Table for Select Elements” y nos mostrará la siguiente ventana.

Project: Cuenca Chicama Simulation Run: Run 1
Subbasin: Subbasin-1

Start of Run: 01jul2020, 00:00 Basin Model: Basin 1
End of Run: 02jul2020, 05:00 Meteorologic Model: Met 1
Compute Time: 17jul2020, 05:23:18 Control Specifications: Control 1

Date	Time	Precip (MM)	Loss (MM)	Excess (MM)	Direct Flow (M3/S)	Baseflow (M3/S)	Total Flow (M3/S)
01jul2020	00:00				0.0	0.0	0.0
01jul2020	01:00	16.46	16.46	0.00	0.0	0.0	0.0
01jul2020	02:00	40.89	31.35	9.54	105.5	0.0	105.5
01jul2020	03:00	12.11	6.09	6.02	396.6	0.0	396.6
01jul2020	04:00	0.00	0.00	0.00	903.2	0.0	903.2
01jul2020	05:00	0.00	0.00	0.00	1374.9	0.0	1374.9
01jul2020	06:00	0.00	0.00	0.00	1565.4	0.0	1565.4
01jul2020	07:00	0.00	0.00	0.00	1481.2	0.0	1481.2
01jul2020	08:00	0.00	0.00	0.00	1241.8	0.0	1241.8
01jul2020	09:00	0.00	0.00	0.00	904.3	0.0	904.3
01jul2020	10:00	0.00	0.00	0.00	621.2	0.0	621.2
01jul2020	11:00	0.00	0.00	0.00	441.3	0.0	441.3
01jul2020	12:00	0.00	0.00	0.00	316.0	0.0	316.0
01jul2020	13:00	0.00	0.00	0.00	224.1	0.0	224.1
01jul2020	14:00	0.00	0.00	0.00	159.1	0.0	159.1
01jul2020	15:00	0.00	0.00	0.00	112.7	0.0	112.7
01jul2020	16:00	0.00	0.00	0.00	79.6	0.0	79.6
01jul2020	17:00	0.00	0.00	0.00	56.8	0.0	56.8
01jul2020	18:00	0.00	0.00	0.00	40.6	0.0	40.6
01jul2020	19:00	0.00	0.00	0.00	28.7	0.0	28.7
01jul2020	20:00	0.00	0.00	0.00	20.4	0.0	20.4
01jul2020	21:00	0.00	0.00	0.00	14.9	0.0	14.9
01jul2020	22:00	0.00	0.00	0.00	10.8	0.0	10.8
01jul2020	23:00	0.00	0.00	0.00	7.4	0.0	7.4
02jul2020	00:00	0.00	0.00	0.00	4.0	0.0	4.0
02jul2020	01:00	0.00	0.00	0.00	1.1	0.0	1.1
02jul2020	02:00	0.00	0.00	0.00	0.0	0.0	0.0
02jul2020	03:00	0.00	0.00	0.00	0.0	0.0	0.0
02jul2020	04:00	0.00	0.00	0.00	0.0	0.0	0.0
02jul2020	05:00	0.00	0.00	0.00	0.0	0.0	0.0

Ilustración 75: Resultados del Caudal de Entrada

4.5. Elección de la Mejor Propuesta

4.5.1. Condiciones

-Cantidad de agua almacenada (MM):

El embalse debe tener la mayor cantidad posible de agua almacenada.

-Altura de la presa(m):

La presa debe tener la menor altura posible, ya que a menor altura necesitará menor cantidad de material, por consiguiente, tendrá menor costo en su construcción.

-Longitud de la presa(m):

La presa debe tener la menor longitud posible, ya que a menor longitud necesitará menor cantidad de material, por consiguiente, tendrá menor costo en su construcción.

4.5.2. Cuadro Resumen

	CANTIDAD DE AGUA ALMACENADA (MM)	ALTURA DE LA PRESA (m)	LONGITUD DE LA PRESA (m)
PROPUESTA 1	25.71	32.00	366.91
PROPUESTA 2	16.88	37.00	380.90
PROPUESTA 3	18.69	31.00	656.26

Tabla 100: Cuadro Resumen de las Propuestas

4.5.3. Elección

La PROPUESTA 1 es la que reúne todas las condiciones necesarias para nuestro proyecto, con una cantidad de 25.71 millones de metros cúbicos de agua almacenada en el embalse, con una altura de presa de 32 metros y con una longitud de presa de 366.91 metros.

4.6. Cálculo del Caudal Laminado

4.6.1. Tránsito de Avenidas

4.6.1.1. Propuesta 1

4.6.1.1.1. Aliviadero L=25

a) Coeficientes

L	a	b	c	d
25	-0.00000002	0.0001	0.0611	-1E-11

Tabla 101: Coeficientes de línea de tendencia para L=25m

b) Cálculos

T	I (m3/s)	I MEDIO	N	DELTA N	Q
0	0.00	-	0.000000		0.00
1	0.00	0.00	0.000000	0.000000	0.00
2	105.50	52.75	52.750000	52.750000	3.50
3	396.60	251.05	300.301654	247.551654	26.82
4	903.20	649.90	923.376745	623.075091	125.93
5	1374.90	1139.05	1936.491840	1013.115094	348.08
6	1565.40	1470.15	3058.559037	1122.067197	550.11
7	1481.20	1523.30	4031.745886	973.186850	561.12
8	1241.80	1361.50	4832.127287	800.381400	373.64
9	904.30	1073.05	5531.539585	699.412298	12.70
10	621.20	762.75	6281.592739	750.053154	-627.59
11	441.30	531.25	7440.429589	1158.836850	-2247.43
12	316.00	378.65	10066.512614	2626.083025	-9653.20
13	224.10	270.05	19989.766999	9923.254385	-118574.08
14	159.10	191.60	138755.447388	118765.680389	#####
15	112.10	135.60	#####	#####	#####
16	79.60	95.85	#####	#####	#####
17	56.80	68.20	#####	#####	#####
18	40.60	48.70	#####	#####	#¡NUM!
19	28.70	34.65	#¡NUM!	#¡NUM!	#¡NUM!
20	20.40	24.55	#¡NUM!	#¡NUM!	#¡NUM!
21	14.90	17.65	#¡NUM!	#¡NUM!	#¡NUM!
22	10.80	12.85	#¡NUM!	#¡NUM!	#¡NUM!
23	7.40	9.10	#¡NUM!	#¡NUM!	#¡NUM!
24	4.00	5.70	#¡NUM!	#¡NUM!	#¡NUM!
25	1.10	2.55	#¡NUM!	#¡NUM!	#¡NUM!
26	0.00	0.55	#¡NUM!	#¡NUM!	#¡NUM!
27	0.00	0.00	#¡NUM!	#¡NUM!	#¡NUM!
28	0.00	0.00	#¡NUM!	#¡NUM!	#¡NUM!
29	0.00	0.00	#¡NUM!	#¡NUM!	#¡NUM!

Tabla 102: Cálculos del Tránsito de Avenidas para L=25m

c) Gráfico

Error en la Gráfica.

4.6.1.1.2. Aliviadero L=50

a) Coeficientes

L	a	b	c	d
50	-0.00000004	0.0002	0.124	-2E-11

Tabla 103: Coeficientes de línea de tendencia para L=50m

b) Cálculos

T	I (m3/s)	I MEDIO	N	DELTA N	Q
0	0.00	-	0.000000		0.00
1	0.00	0.00	0.000000	0.000000	0.00
2	105.50	52.75	52.750000	52.750000	7.09
3	396.60	251.05	296.708359	243.958359	53.35
4	903.20	649.90	893.254191	596.545832	241.83
5	1374.90	1139.05	1790.469271	897.215080	633.58
6	1565.40	1470.15	2627.039078	836.569806	980.82
7	1481.20	1523.30	3169.522366	542.483289	1128.57
8	1241.80	1361.50	3402.451830	232.929464	1161.68
9	904.30	1073.05	3313.825744	-88.626086	1151.58
10	621.20	762.75	2924.996423	-388.829321	1072.82
11	441.30	531.25	2383.430505	-541.565919	890.11
12	316.00	378.65	1871.972981	-511.457524	670.58
13	224.10	270.05	1471.438675	-400.534306	488.05
14	159.10	191.60	1174.988269	-296.450405	356.93
15	112.10	135.60	953.657669	-221.330601	265.45
16	79.60	95.85	784.054181	-169.603488	200.89
17	56.80	68.20	651.362879	-132.691301	154.57
18	40.60	48.70	545.493405	-105.869474	120.66
19	28.70	34.65	459.482359	-86.011046	95.32
20	20.40	24.55	388.712050	-70.770309	76.07
21	14.90	17.65	330.291674	-58.420376	61.33
22	10.80	12.85	281.808283	-48.483391	49.93
23	7.40	9.10	240.976077	-40.832206	40.94
24	4.00	5.70	205.740884	-35.235193	33.63
25	1.10	2.55	174.661507	-31.079377	27.55
26	0.00	0.55	147.665285	-26.996222	22.54
27	0.00	0.00	125.122576	-22.542709	18.57
28	0.00	0.00	106.554600	-18.567976	15.44
29	0.00	0.00	91.119445	-15.435155	12.93

Tabla 104: Cálculos del Tránsito de Avenidas para L=50m

c) Gráfico



Gráfico 48: Gráfico de Caudal de Entrada vs Caudal Laminado para L=50m

4.6.1.1.3. Aliviadero L=75

a) Coeficientes

L	a	b	c	d
75	-0.00000004	0.0002	0.1867	-4E-11

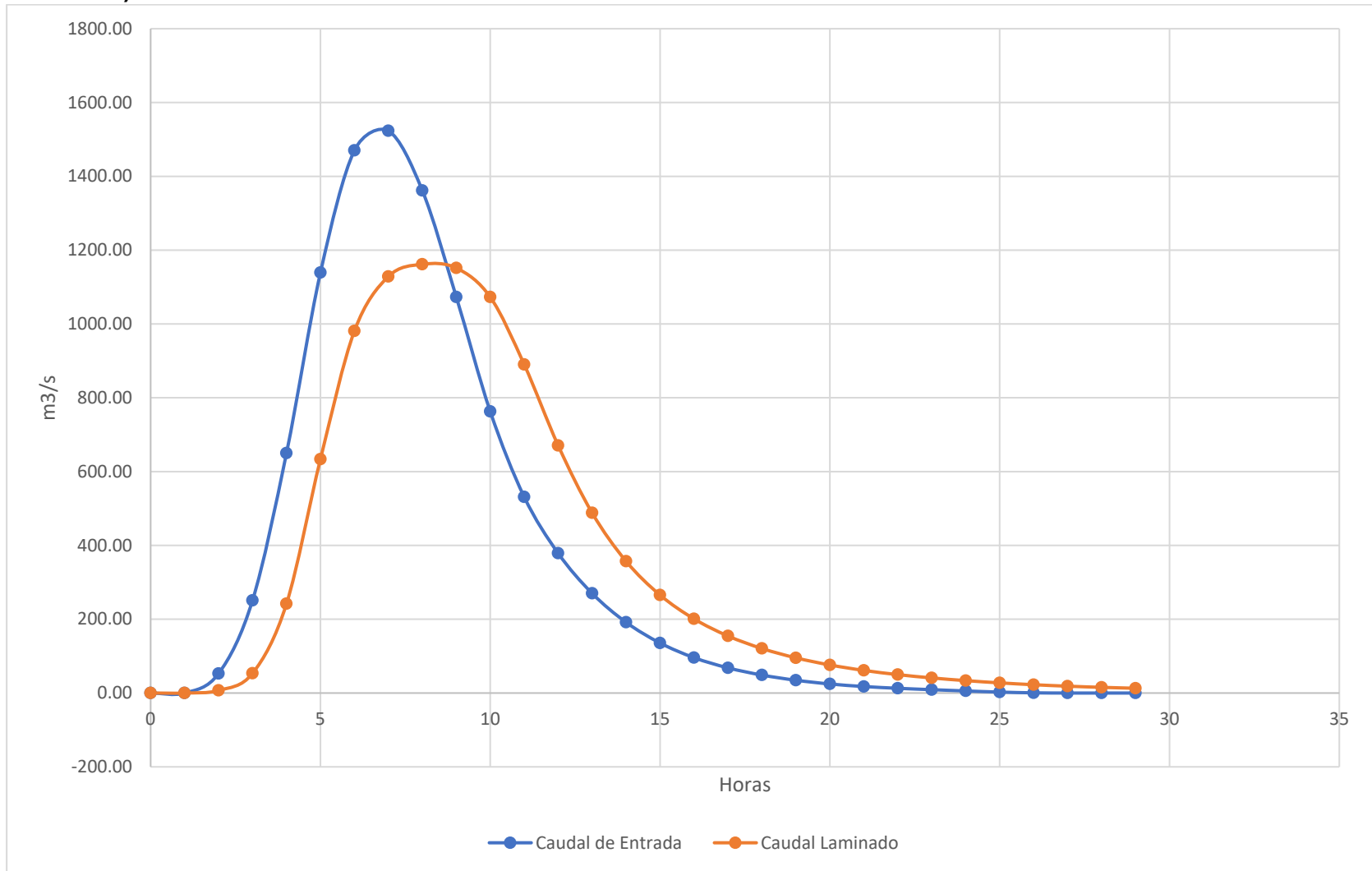
Tabla 105: Coeficientes de línea de tendencia para L=75m

b) Cálculos

T	I (m3/s)	I MEDIO	N	DELTA N	Q
0	0.00	-	0.000000		0.00
1	0.00	0.00	0.000000	0.000000	0.00
2	105.50	52.75	52.750000	52.750000	10.40
3	396.60	251.05	293.400934	240.650934	70.98
4	903.20	649.90	872.316444	578.915510	288.50
5	1374.90	1139.05	1722.868847	850.552403	710.76
6	1565.40	1470.15	2482.261904	759.393057	1083.97
7	1481.20	1523.30	2921.589371	439.327467	1255.09
8	1241.80	1361.50	3028.002344	106.412973	1288.56
9	904.30	1073.05	2812.490364	-215.511980	1217.23
10	621.20	762.75	2358.011435	-454.478929	1027.84
11	441.30	531.25	1861.419413	-496.592022	782.52
12	316.00	378.65	1457.549924	-403.869489	573.16
13	224.10	270.05	1154.444778	-303.105146	420.54
14	159.10	191.60	925.504505	-228.940273	312.39
15	112.10	135.60	748.711050	-176.793456	235.11
16	79.60	95.85	609.451195	-139.259855	179.02
17	56.80	68.20	498.635262	-110.815933	137.86
18	40.60	48.70	409.471803	-89.163459	107.24
19	28.70	34.65	336.886185	-72.585618	84.07
20	20.40	24.55	277.370433	-59.515751	66.32
21	14.90	17.65	228.702075	-48.668359	52.68
22	10.80	12.85	188.870957	-39.831118	42.13
23	7.40	9.10	155.843799	-33.027157	33.80
24	4.00	5.70	127.741705	-28.102094	27.03
25	1.10	2.55	103.262119	-24.479586	21.37
26	0.00	0.55	82.444512	-20.817607	16.73
27	0.00	0.00	65.715118	-16.729395	13.12
28	0.00	0.00	52.593761	-13.121356	10.37
29	0.00	0.00	42.227105	-10.366657	8.24

Tabla 106: Cálculos del Tránsito de Avenidas para L=75m

c) Gráfico



Gráfico 49: Gráfico de Caudal de Entrada vs Caudal Laminado para L=75m

4.6.1.1.4. Aliviadero L=100

a) Coeficientes

L	a	b	c	d
100	-0.00000005	0.0002	0.2481	4E-11

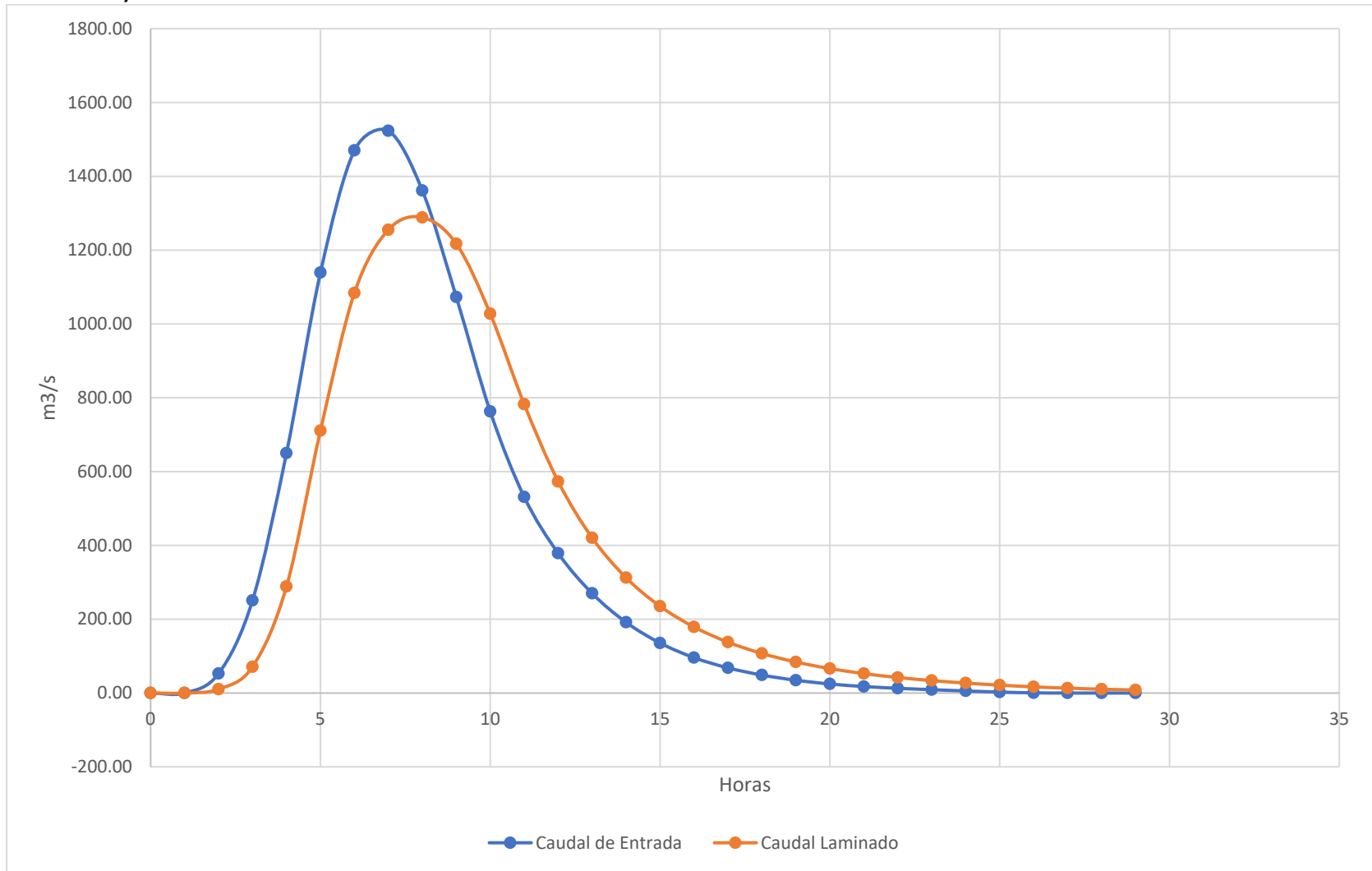
Tabla 107: Coeficientes de línea de tendencia para L=100m

b) Cálculos

T	I (m3/s)	I MEDIO	N	DELTA N	Q
0	0.00	-	0.000000		0.00
1	0.00	0.00	0.000000	0.000000	0.00
2	105.50	52.75	52.750000	52.750000	13.64
3	396.60	251.05	290.163552	237.413552	87.61
4	903.20	649.90	852.456511	562.292960	325.86
5	1374.90	1139.05	1665.648875	813.192363	737.07
6	1565.40	1470.15	2398.731815	733.082940	1055.80
7	1481.20	1523.30	2866.228454	467.496640	1176.82
8	1241.80	1361.50	3050.905459	184.677004	1198.64
9	904.30	1073.05	2925.316070	-125.589388	1185.60
10	621.20	762.75	2502.466158	-422.849912	1089.76
11	441.30	531.25	1943.951234	-558.514924	870.78
12	316.00	378.65	1451.822029	-492.129205	628.75
13	224.10	270.05	1093.124138	-358.697891	444.88
14	159.10	191.60	839.845778	-253.278359	319.82
15	112.10	135.60	655.630735	-184.215044	234.54
16	79.60	95.85	516.939615	-138.691119	174.79
17	56.80	68.20	410.348584	-106.591032	132.03
18	40.60	48.70	327.018755	-83.329829	100.77
19	28.70	34.65	260.895739	-66.123016	77.45
20	20.40	24.55	207.992103	-52.903636	59.81
21	14.90	17.65	165.837013	-42.155089	46.42
22	10.80	12.85	132.270509	-33.566504	36.20
23	7.40	9.10	105.170805	-27.099704	28.25
24	4.00	5.70	82.623913	-22.546892	21.84
25	1.10	2.55	63.337780	-19.286133	16.50
26	0.00	0.55	47.384047	-15.953734	12.20
27	0.00	0.00	35.184335	-12.199712	8.97
28	0.00	0.00	26.209692	-8.974643	6.64
29	0.00	0.00	19.570578	-6.639114	4.93

Tabla 108: Cálculos del Tránsito de Avenidas para L=100m

c) Gráfico



Gráfico 50: Gráfico de Caudal de Entrada vs Caudal Laminado para L=100m

4.6.1.1.5. Aliviadero L=125

a) Coeficientes

L	a	b	c	d
125	-0.00000005	0.0003	0.3073	2E-11

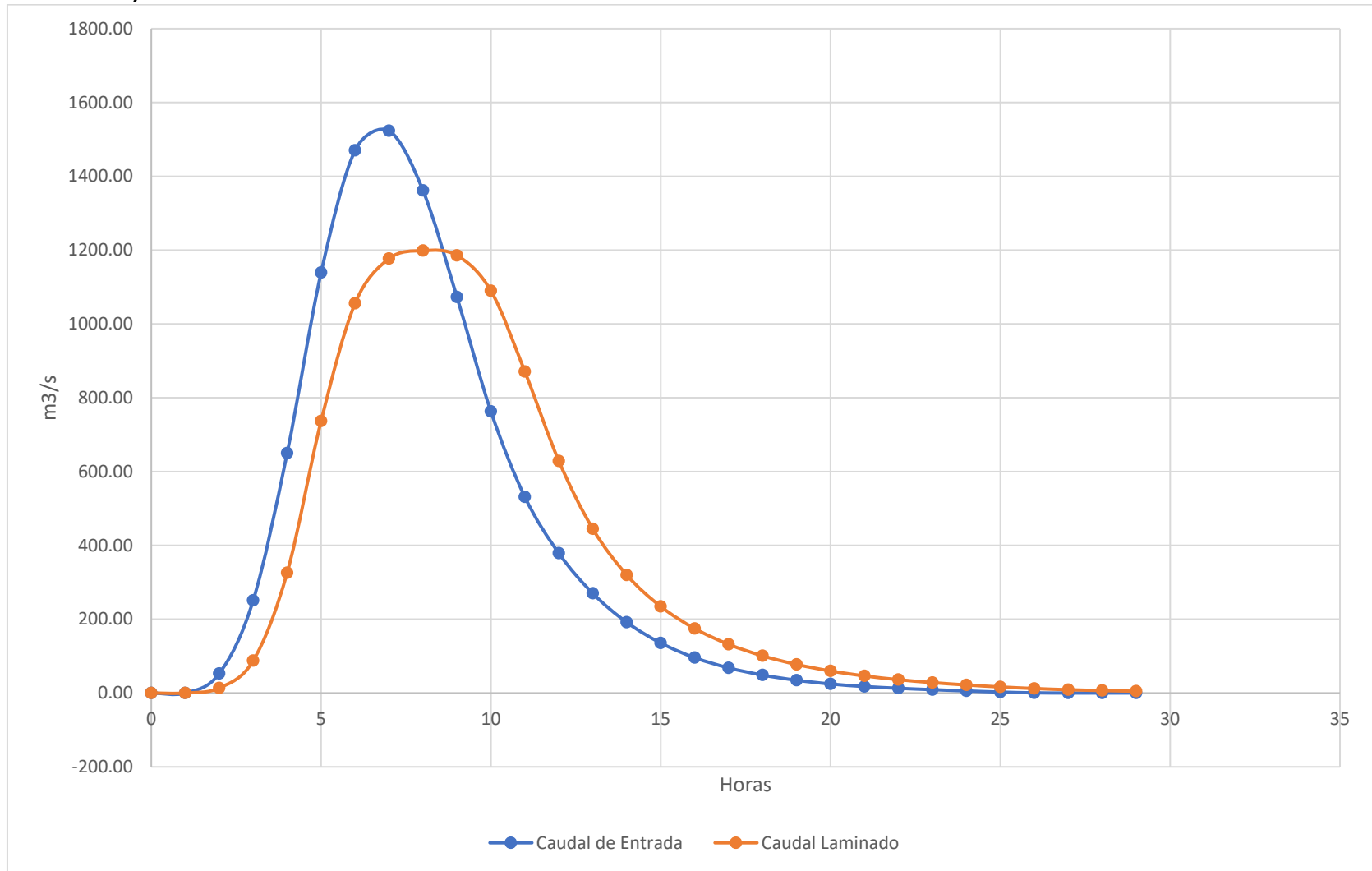
Tabla 109: Coeficientes de línea de tendencia para L=125m

b) Cálculos

T	I (m3/s)	I MEDIO	N	DELTA N	Q
0	0.00	-	0.000000		0.00
1	0.00	0.00	0.000000	0.000000	0.00
2	105.50	52.75	52.750000	52.750000	17.04
3	396.60	251.05	286.762495	234.012495	111.61
4	903.20	649.90	825.049625	538.287130	429.67
5	1374.90	1139.05	1534.430658	709.381033	997.23
6	1565.40	1470.15	2007.346002	472.915344	1421.27
7	1481.20	1523.30	2109.380994	102.034992	1513.78
8	1241.80	1361.50	1957.105051	-152.275943	1375.69
9	904.30	1073.05	1654.469692	-302.635359	1103.16
10	621.20	762.75	1314.056677	-340.413015	808.38
11	441.30	531.25	1036.925612	-277.131065	585.47
12	316.00	378.65	830.109838	-206.815773	433.22
13	224.10	270.05	666.943084	-163.166755	323.56
14	159.10	191.60	534.980801	-131.962282	242.61
15	112.10	135.60	427.975558	-107.005243	182.55
16	79.60	95.85	341.279212	-86.696347	137.83
17	56.80	68.20	271.650125	-69.629087	104.61
18	40.60	48.70	215.736209	-55.913916	79.76
19	28.70	34.65	170.629879	-45.106330	60.92
20	20.40	24.55	134.259341	-36.370538	46.54
21	14.90	17.65	105.364780	-28.894562	35.65
22	10.80	12.85	82.564148	-22.800631	27.39
23	7.40	9.10	64.275275	-18.288873	20.98
24	4.00	5.70	48.997367	-15.277908	15.77
25	1.10	2.55	35.776135	-13.221232	11.38
26	0.00	0.55	24.950439	-10.825696	7.85
27	0.00	0.00	17.097188	-7.853251	5.34
28	0.00	0.00	11.755778	-5.341410	3.65
29	0.00	0.00	8.101849	-3.653929	2.51

Tabla 110: Cálculos del Tránsito de Avenidas para L=125m

c) Gráfico



Gráfico 51: Gráfico de Caudal de Entrada vs Caudal Laminado para L=125m

4.6.1.1.6. Aliviadero L=150

a) Coeficientes

L	a	b	c	d
150	-0.00000005	0.0003	0.3641	-1E-10

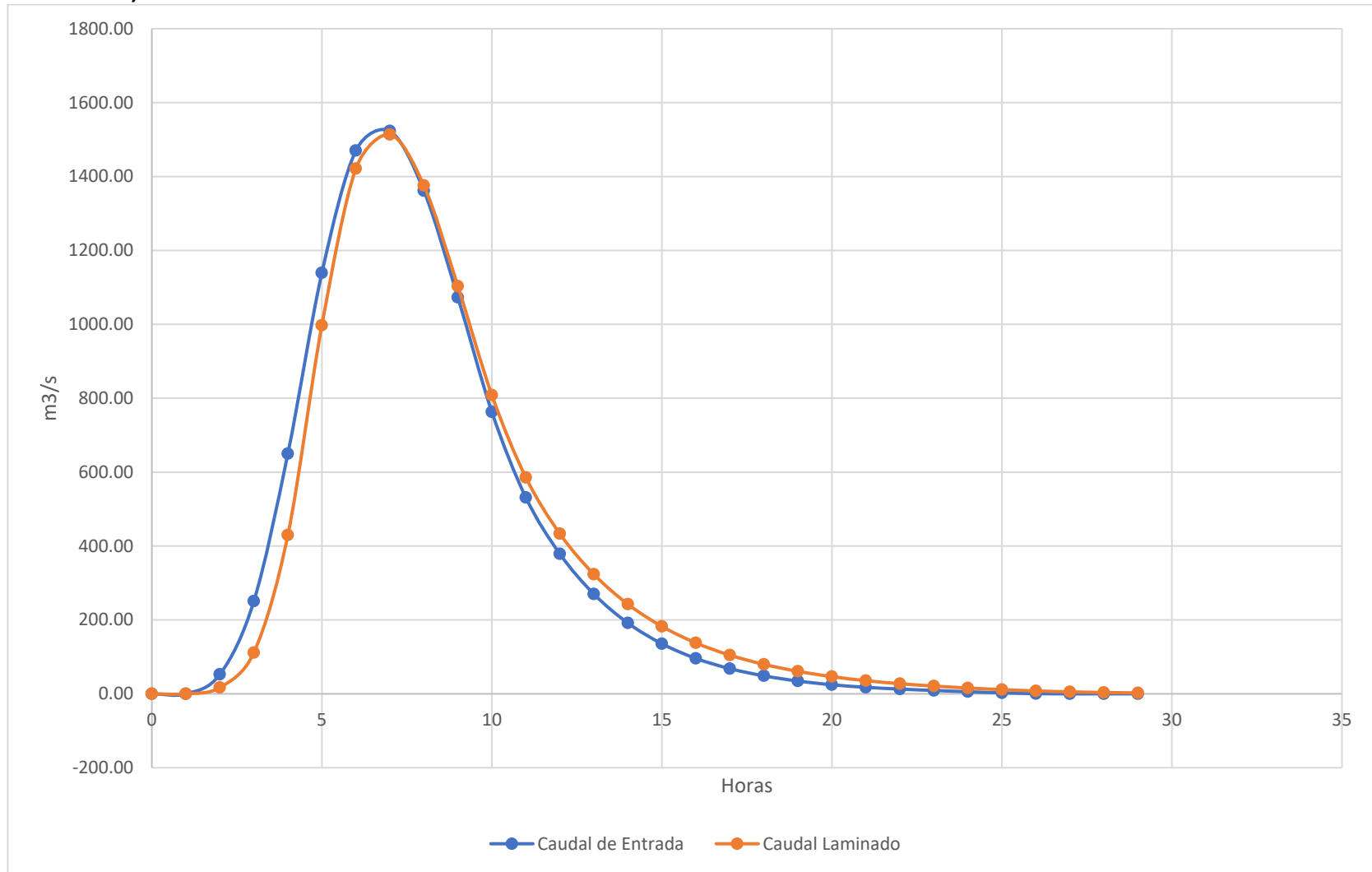
Tabla 111: Coeficientes de línea de tendencia para L=150m

b) Cálculos

T	I (m3/s)	I MEDIO	N	DELTA N	Q
0	0.00	-	0.000000		0.00
1	0.00	0.00	0.000000	0.000000	0.00
2	105.50	52.75	52.750000	52.750000	20.03
3	396.60	251.05	283.766295	231.016295	126.33
4	903.20	649.90	807.332484	523.566189	463.18
5	1374.90	1139.05	1483.207395	675.874911	1036.86
6	1565.40	1470.15	1916.496037	433.288642	1447.72
7	1481.20	1523.30	1992.073094	75.577058	1520.56
8	1241.80	1361.50	1833.015399	-159.057695	1367.44
9	904.30	1073.05	1538.622444	-294.392955	1088.30
10	621.20	762.75	1213.075891	-325.546553	793.89
11	441.30	531.25	950.434304	-262.641587	574.12
12	316.00	378.65	754.961135	-195.473169	424.36
13	224.10	270.05	600.655012	-154.306123	316.10
14	159.10	191.60	476.155998	-124.499014	235.99
15	112.10	135.60	375.768051	-100.387947	176.52
16	79.60	95.85	295.093368	-80.674683	132.28
17	56.80	68.20	231.010682	-64.082686	99.50
18	40.60	48.70	180.206317	-50.804365	75.06
19	28.70	34.65	139.793506	-40.412811	56.62
20	20.40	24.55	107.718617	-32.074889	42.64
21	14.90	17.65	82.729773	-24.988844	32.15
22	10.80	12.85	63.432909	-19.296864	24.29
23	7.40	9.10	48.242629	-15.190281	18.26
24	4.00	5.70	35.684896	-12.557733	13.37
25	1.10	2.55	24.862274	-10.822622	9.24
26	0.00	0.55	16.175249	-8.687025	5.97
27	0.00	0.00	10.207561	-5.967688	3.75
28	0.00	0.00	6.459783	-3.747778	2.36
29	0.00	0.00	4.095271	-2.364512	1.50

Tabla 112: Cálculos del Tránsito de Avenidas para L=150m

c) Gráfico



Gráfico 52: Gráfico de Caudal de Entrada vs Caudal Laminado para L=150m

4.6.1.1.7. Aliviadero L=175

a) Coeficientes

L	a	b	c	d
175	-0.00000004	0.0003	0.4183	7E-11

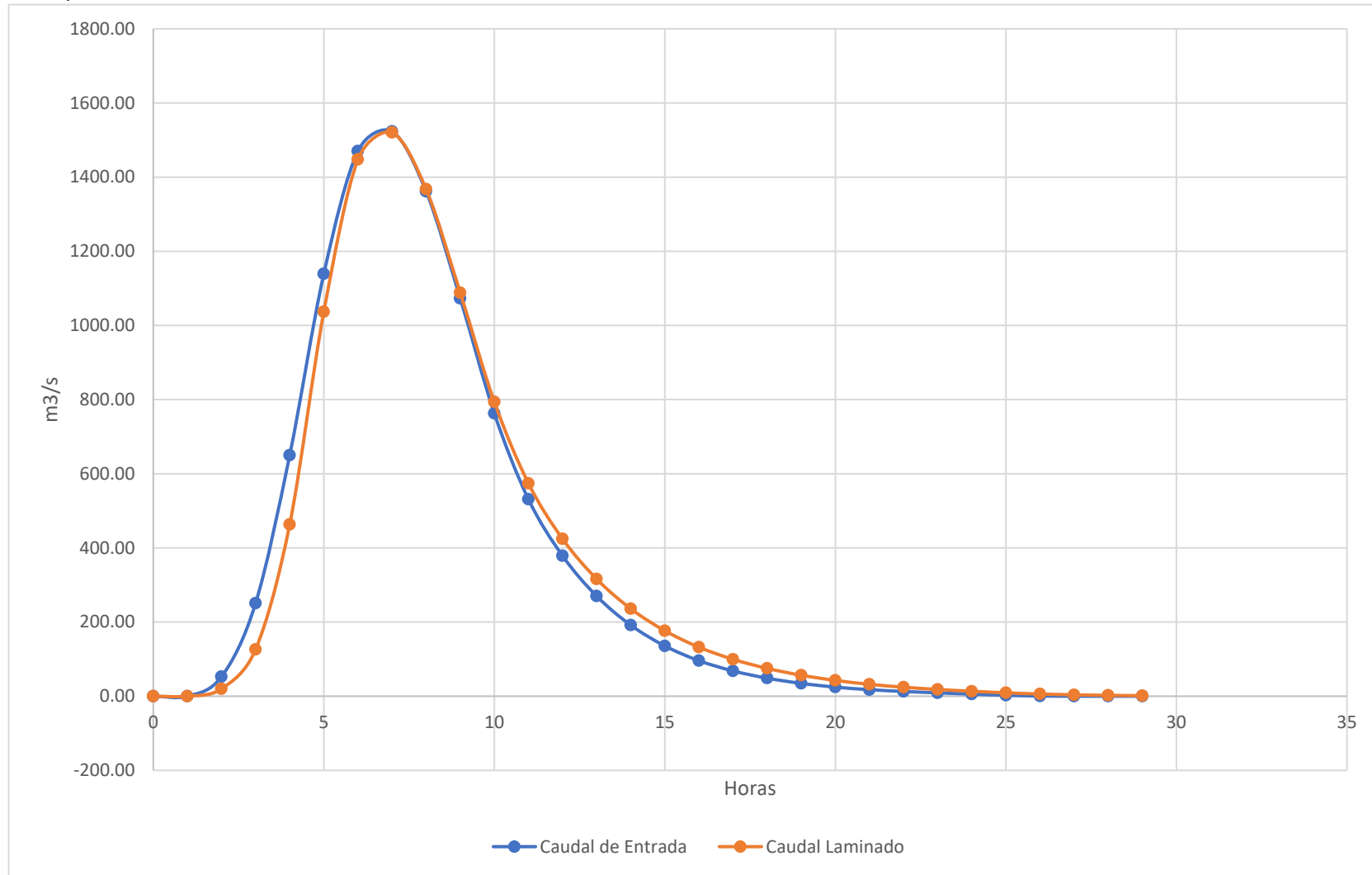
Tabla 113: Coeficientes de línea de tendencia para L=175m

b) Cálculos

T	I (m3/s)	I MEDIO	N	DELTA N	Q
0	0.00	-	0.000000		0.00
1	0.00	0.00	0.000000	0.000000	0.00
2	105.50	52.75	52.750000	52.750000	22.89
3	396.60	251.05	280.905777	228.155777	140.29
4	903.20	649.90	790.517103	509.611326	498.39
5	1374.90	1139.05	1431.178924	640.661821	1095.89
6	1565.40	1470.15	1805.442659	374.263735	1497.70
7	1481.20	1523.30	1831.041547	25.598888	1526.18
8	1241.80	1361.50	1666.361207	-164.680341	1344.98
9	904.30	1073.05	1394.427796	-271.933410	1058.16
10	621.20	762.75	1099.014612	-295.413184	768.97
11	441.30	531.25	861.293914	-237.720698	557.27
12	316.00	378.65	682.673758	-178.620156	412.65
13	224.10	270.05	540.074513	-142.599246	307.12
14	159.10	191.60	424.558368	-115.516145	228.61
15	112.10	135.60	331.551723	-93.006645	170.21
16	79.60	95.85	257.193527	-74.358196	126.75
17	56.80	68.20	198.645440	-58.548087	94.62
18	40.60	48.70	152.727591	-45.917849	70.74
19	28.70	34.65	116.636424	-36.091167	52.81
20	20.40	24.55	88.379660	-28.256764	39.28
21	14.90	17.65	66.744772	-21.634888	29.24
22	10.80	12.85	50.350868	-16.393904	21.82
23	7.40	9.10	37.633643	-12.717225	16.16
24	4.00	5.70	27.168735	-10.464908	11.59
25	1.10	2.55	18.133413	-9.035322	7.68
26	0.00	0.55	10.999799	-7.133614	4.64
27	0.00	0.00	6.362338	-4.637461	2.67
28	0.00	0.00	3.688838	-2.673499	1.55
29	0.00	0.00	2.141717	-1.547121	0.90

Tabla 114: Cálculos del Tránsito de Avenidas para L=175m

c) Gráfico



Gráfico 53: Gráfico de Caudal de Entrada vs Caudal Laminado para L=175m

4.6.1.1.8. Aliviadero L=200

a) Coeficientes

L	a	b	c	d
200	-0.00000004	0.0003	0.4698	2E-10

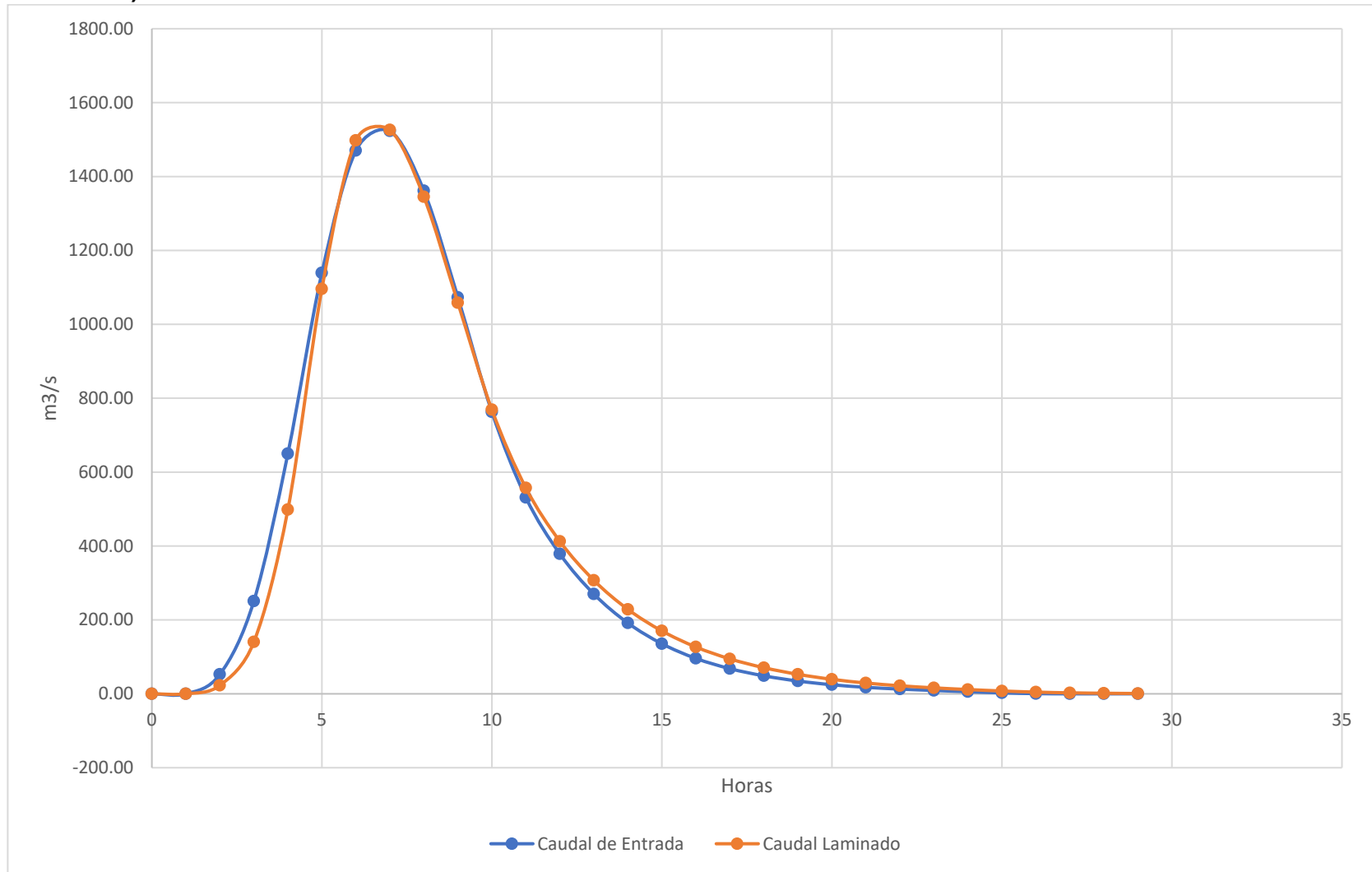
Tabla 115: Coeficientes de línea de tendencia para L=200m

b) Cálculos

T	I (m3/s)	I MEDIO	N	DELTA N	Q
0	0.00	-	0.000000		0.00
1	0.00	0.00	0.000000	0.000000	0.00
2	105.50	52.75	52.750000	52.750000	25.61
3	396.60	251.05	278.189152	225.439152	153.05
4	903.20	649.90	775.040281	496.851128	525.70
5	1374.90	1139.05	1388.392404	613.352123	1123.50
6	1565.40	1470.15	1735.038079	346.645675	1509.30
7	1481.20	1523.30	1749.033419	13.995340	1525.41
8	1241.80	1361.50	1585.122126	-163.911293	1339.16
9	904.30	1073.05	1319.009990	-266.112136	1049.82
10	621.20	762.75	1031.944767	-287.065223	760.32
11	441.30	531.25	802.871247	-229.073520	549.87
12	316.00	378.65	631.652968	-171.218279	406.37
13	224.10	270.05	495.337576	-136.315391	301.46
14	159.10	191.60	385.481616	-109.855960	223.39
15	112.10	135.60	297.694772	-87.786844	165.39
16	79.60	95.85	228.156409	-69.538363	122.33
17	56.80	68.20	174.026995	-54.129415	90.63
18	40.60	48.70	132.094313	-41.932681	67.20
19	28.70	34.65	99.543929	-32.550385	49.70
20	20.40	24.55	74.394948	-25.148981	36.59
21	14.90	17.65	55.450289	-18.944659	26.97
22	10.80	12.85	41.334143	-14.116146	19.93
23	7.40	9.10	30.505634	-10.828509	14.61
24	4.00	5.70	21.596044	-8.909589	10.29
25	1.10	2.55	13.860709	-7.735336	6.57
26	0.00	0.55	7.841419	-6.019290	3.70
27	0.00	0.00	4.139093	-3.702326	1.95
28	0.00	0.00	2.189410	-1.949683	1.03
29	0.00	0.00	1.159388	-1.030023	0.55

Tabla 116: Cálculos del Tránsito de Avenidas para L=200m

c) Gráfico



Gráfico 54: Gráfico de Caudal de Entrada vs Caudal Laminado para L=200m

4.6.1.1.9. Aliviadero L=225

a) Coeficientes

L	a	b	c	d
225	-0.00000004	0.0003	0.5187	-4E-11

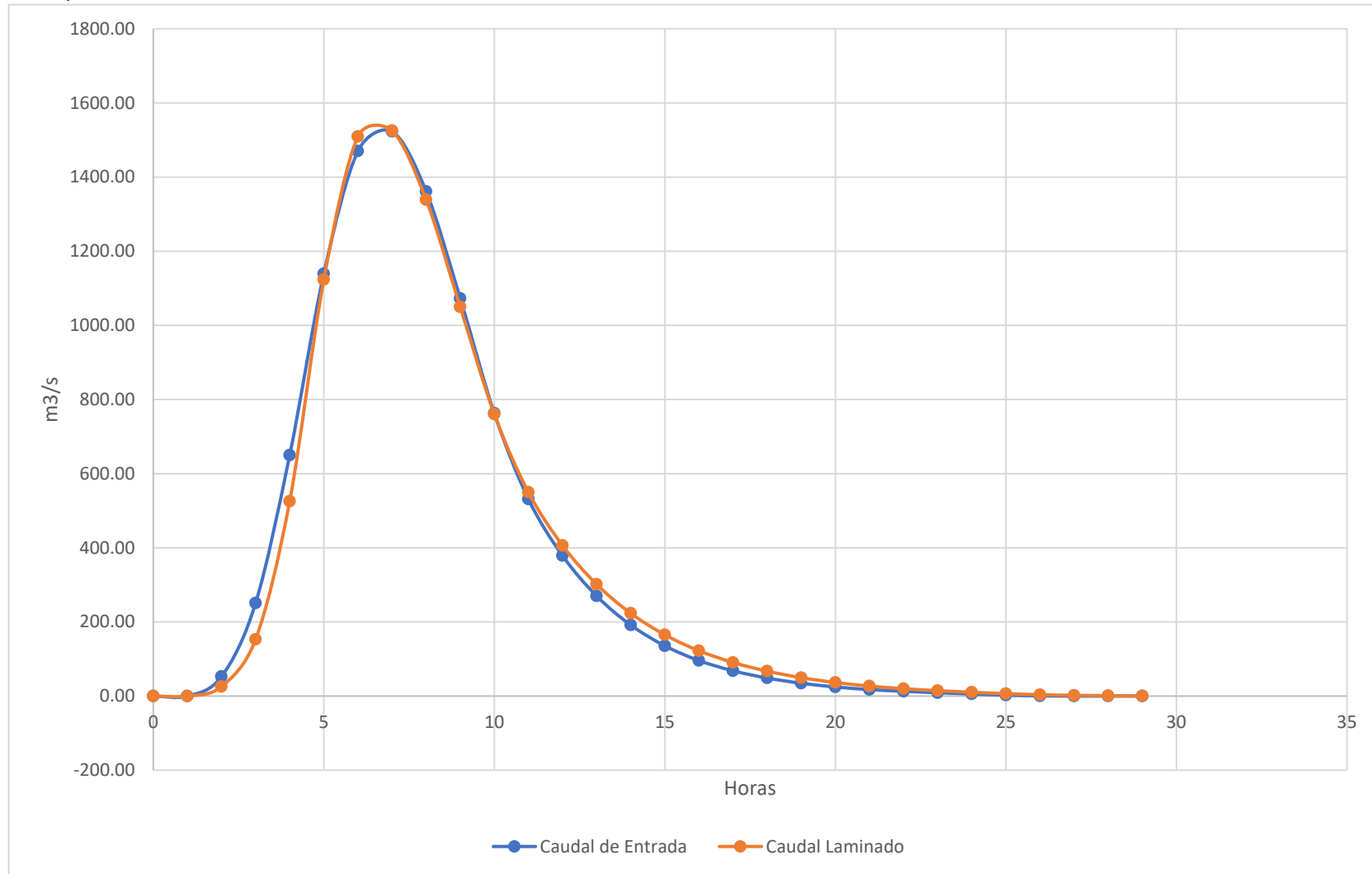
Tabla 117: Coeficientes de línea de tendencia para L=225m

b) Cálculos

T	I (m3/s)	I MEDIO	N	DELTA N	Q
0	0.00	-	0.000000		0.00
1	0.00	0.00	0.000000	0.000000	0.00
2	105.50	52.75	52.750000	52.750000	28.19
3	396.60	251.05	275.609677	222.859677	164.91
4	903.20	649.90	760.600150	484.990472	550.48
5	1374.90	1139.05	1349.173746	588.573597	1147.66
6	1565.40	1470.15	1671.660794	322.487048	1518.57
7	1481.20	1523.30	1676.390285	4.729491	1524.18
8	1241.80	1361.50	1513.706666	-162.683619	1333.82
9	904.30	1073.05	1252.939377	-260.767289	1042.18
10	621.20	762.75	973.510028	-279.429349	752.37
11	441.30	531.25	752.388510	-221.121517	543.05
12	316.00	378.65	587.984787	-164.403723	400.57
13	224.10	270.05	457.460513	-130.524274	296.24
14	159.10	191.60	352.824021	-104.636492	218.60
15	112.10	135.60	269.825613	-82.998408	161.01
16	79.60	95.85	204.661105	-65.164509	118.38
17	56.80	68.20	154.480438	-50.180667	87.14
18	40.60	48.70	116.039635	-38.440803	64.17
19	28.70	34.65	86.522817	-29.516818	47.10
20	20.40	24.55	63.973482	-22.549336	34.40
21	14.90	17.65	47.223128	-16.750354	25.16
22	10.80	12.85	34.913696	-12.309431	18.47
23	7.40	9.10	25.539975	-9.373722	13.44
24	4.00	5.70	17.797369	-7.742606	9.33
25	1.10	2.55	11.021075	-6.776294	5.75
26	0.00	0.55	5.818058	-5.203017	3.03
27	0.00	0.00	2.790084	-3.027974	1.45
28	0.00	0.00	1.340533	-1.449551	0.70
29	0.00	0.00	0.644660	-0.695873	0.33

Tabla 118: Cálculos del Tránsito de Avenidas para L=225m

c) Gráfico



Gráfico 55: Gráfico de Caudal de Entrada vs Caudal Laminado para L=225m

4.6.1.1.10. Aliviadero L=250

a) Coeficientes

L	a	b	c	d
250	-0.00000004	0.0002	0.5651	9E-11

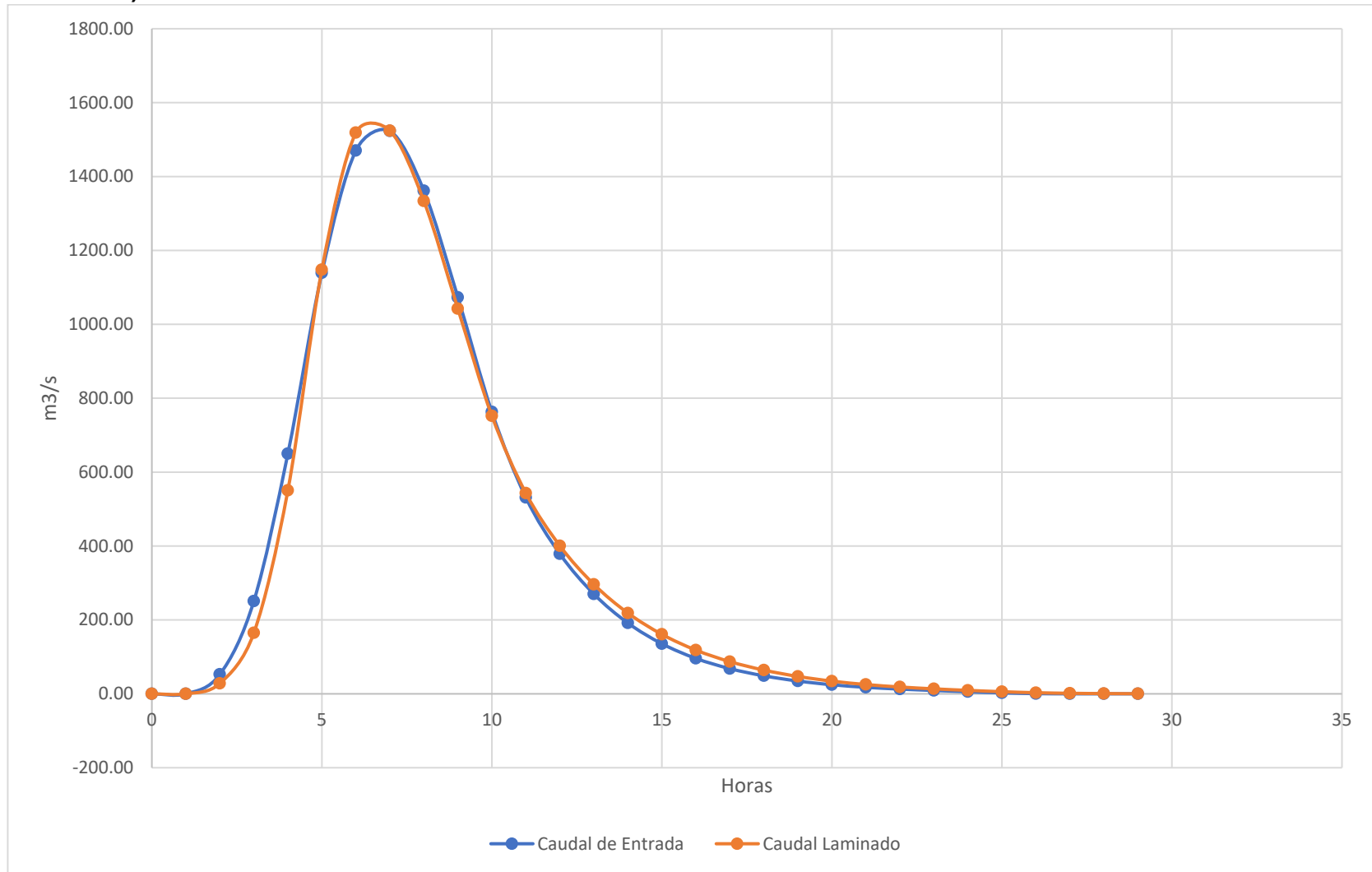
Tabla 119: Coeficientes de línea de tendencia para L=250m

b) Cálculos

T	I (m3/s)	I MEDIO	N	DELTA N	Q
0	0.00	-	0.000000		0.00
1	0.00	0.00	0.000000	0.000000	0.00
2	105.50	52.75	52.750000	52.750000	30.36
3	396.60	251.05	273.440334	220.690334	168.66
4	903.20	649.90	754.683079	481.242745	523.19
5	1374.90	1139.05	1370.545447	615.862368	1047.20
6	1565.40	1470.15	1793.498269	422.952822	1426.07
7	1481.20	1523.30	1890.726436	97.228167	1513.06
8	1241.80	1361.50	1739.169904	-151.556532	1377.33
9	904.30	1073.05	1434.892120	-304.277784	1104.47
10	621.20	762.75	1093.174363	-341.717757	804.50
11	441.30	531.25	819.920547	-273.253815	575.74
12	316.00	378.65	622.827815	-197.092732	419.88
13	224.10	270.05	472.999077	-149.828738	307.80
14	159.10	191.60	356.794601	-116.204476	225.27
15	112.10	135.60	267.126327	-89.668274	164.46
16	79.60	95.85	198.514392	-68.611934	119.75
17	56.80	68.20	146.965238	-51.549154	87.24
18	40.60	48.70	108.422397	-38.542842	63.57
19	28.70	34.65	79.502799	-28.919598	46.17
20	20.40	24.55	57.881729	-21.621070	33.37
21	14.90	17.65	42.160462	-15.721267	24.18
22	10.80	12.85	30.833082	-11.327380	17.61
23	7.40	9.10	22.320344	-8.512738	12.71
24	4.00	5.70	15.307923	-7.012421	8.70
25	1.10	2.55	9.160693	-6.147230	5.19
26	0.00	0.55	4.517232	-4.643460	2.56
27	0.00	0.00	1.960467	-2.556765	1.11
28	0.00	0.00	0.851839	-1.108628	0.48
29	0.00	0.00	0.370320	-0.481519	0.21

Tabla 120: Cálculos del Tránsito de Avenidas para L=250m

c) Gráfico



Gráfico 56: Gráfico de Caudal de Entrada vs Caudal Laminado para L=250m

4.6.1.1.11. Aliviadero L=275

a) Coeficientes

L	a	b	c	d
275	-0.00000003	0.0002	0.609	1E-10

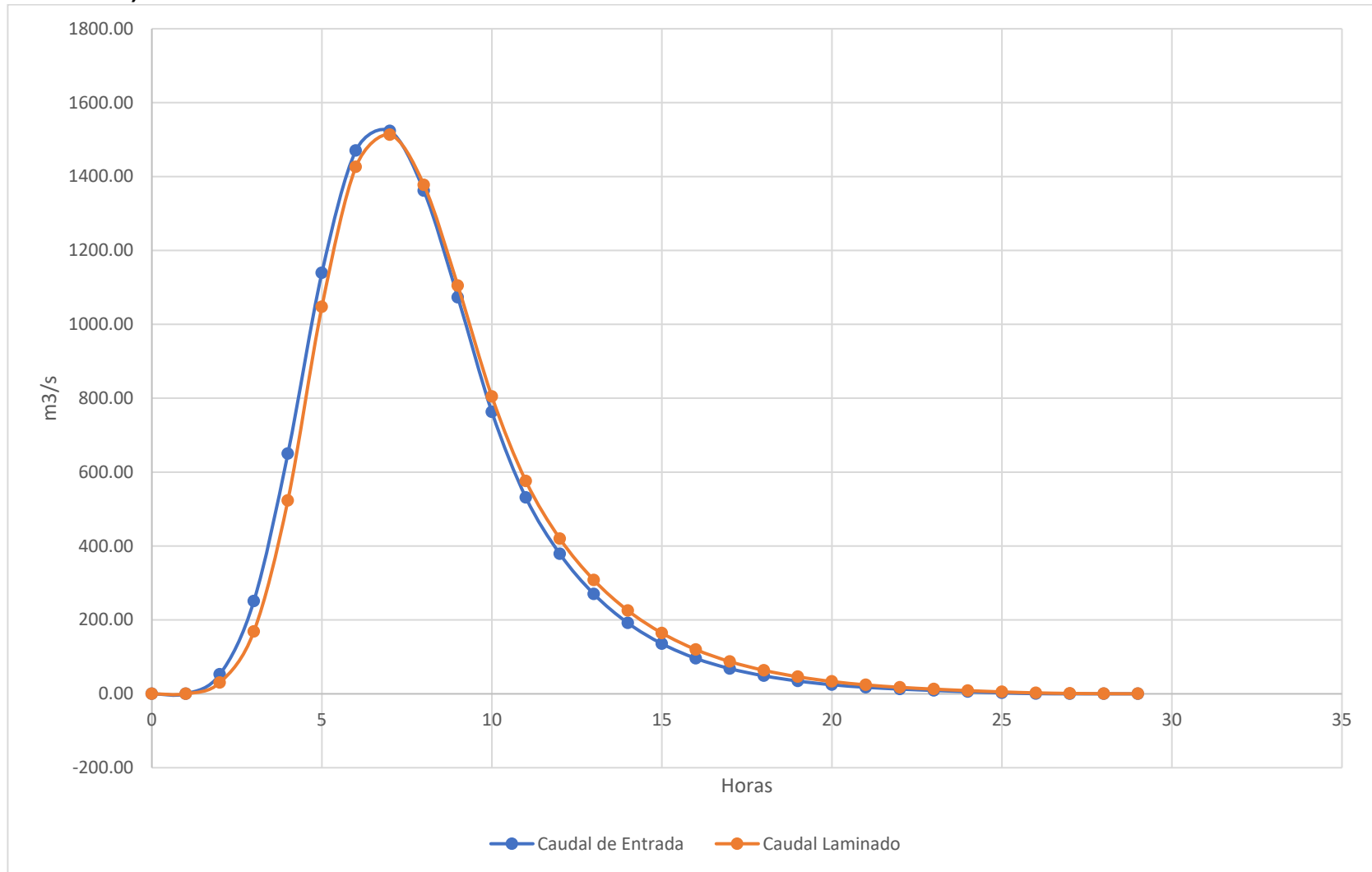
Tabla 121: Coeficientes de línea de tendencia para L=275m

b) Cálculos

T	I (m3/s)	I MEDIO	N	DELTA N	Q
0	0.00	-	0.000000		0.00
1	0.00	0.00	0.000000	0.000000	0.00
2	105.50	52.75	52.750000	52.750000	32.68
3	396.60	251.05	271.123141	218.373141	179.22
4	903.20	649.90	741.805486	470.682345	549.57
5	1374.90	1139.05	1331.286788	589.481302	1094.43
6	1565.40	1470.15	1707.002398	375.715610	1473.12
7	1481.20	1523.30	1757.185336	50.182938	1524.90
8	1241.80	1361.50	1593.789256	-163.396080	1357.20
9	904.30	1073.05	1309.643353	-284.145904	1073.22
10	621.20	762.75	999.175070	-310.468283	778.24
11	441.30	531.25	752.183106	-246.991964	558.47
12	316.00	378.65	572.364801	-179.818305	408.47
13	224.10	270.05	433.949571	-138.415231	299.49
14	159.10	191.60	326.063376	-107.886194	218.80
15	112.10	135.60	242.867301	-83.196076	159.27
16	79.60	95.85	179.443972	-63.423329	115.55
17	56.80	68.20	132.095909	-47.348063	83.87
18	40.60	48.70	96.928784	-35.167125	60.88
19	28.70	34.65	70.697437	-26.231347	44.04
20	20.40	24.55	51.203673	-19.493764	31.70
21	14.90	17.65	37.150300	-14.053373	22.90
22	10.80	12.85	27.101277	-10.049024	16.65
23	7.40	9.10	19.550300	-7.550976	11.98
24	4.00	5.70	13.267949	-6.282352	8.12
25	1.10	2.55	7.702630	-5.565318	4.70
26	0.00	0.55	3.549876	-4.152754	2.16
27	0.00	0.00	1.385483	-2.164394	0.84
28	0.00	0.00	0.541340	-0.844143	0.33
29	0.00	0.00	0.211605	-0.329735	0.13

Tabla 122: Cálculos del Tránsito de Avenidas para L=275m

c) Gráfico



Gráfico 57: Gráfico de Caudal de Entrada vs Caudal Laminado para L=275m

4.6.1.1.12. Aliviadero L=300

a) Coeficientes

L	a	b	c	d
300	-0.00000003	0.0002	0.6506	-3E-11

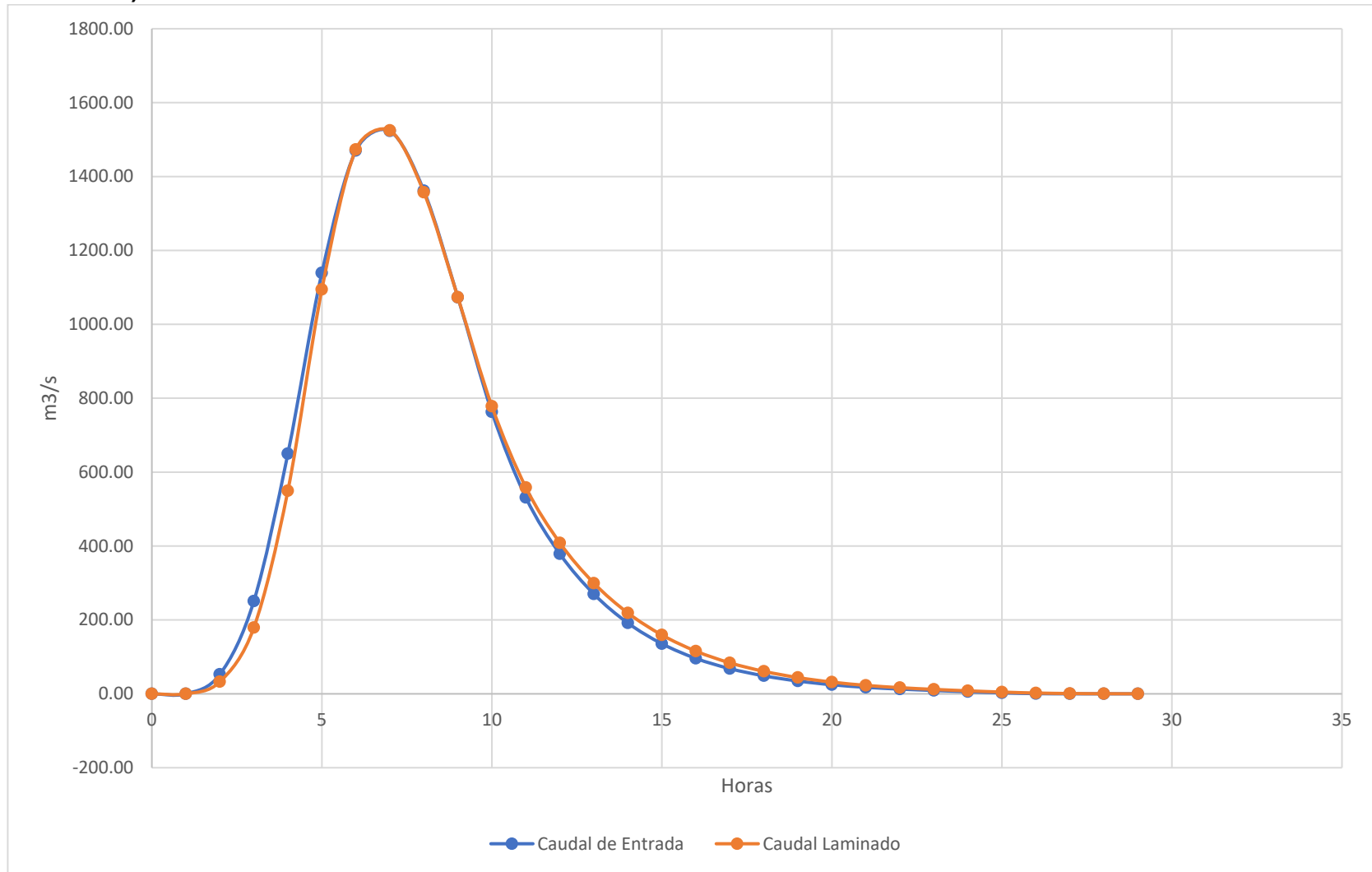
Tabla 123: Coeficientes de línea de tendencia para L=300m

b) Cálculos

T	I (m3/s)	I MEDIO	N	DELTA N	Q
0	0.00	-	0.000000		0.00
1	0.00	0.00	0.000000	0.000000	0.00
2	105.50	52.75	52.750000	52.750000	34.87
3	396.60	251.05	268.928741	216.178741	188.85
4	903.20	649.90	729.982658	461.053917	569.83
5	1374.90	1139.05	1299.200683	569.218025	1117.06
6	1565.40	1470.15	1652.294734	353.094052	1485.67
7	1481.20	1523.30	1689.923002	37.628268	1525.85
8	1241.80	1361.50	1525.575625	-164.347377	1351.50
9	904.30	1073.05	1247.127797	-278.447828	1064.26
10	621.20	762.75	945.621678	-301.506119	768.69
11	441.30	531.25	708.177400	-237.444278	550.39
12	316.00	378.65	536.438990	-171.738410	401.93
13	224.10	270.05	404.559505	-131.879485	293.95
14	159.10	191.60	302.205821	-102.353684	214.05
15	112.10	135.60	223.753041	-78.452780	155.25
16	79.60	95.85	164.352297	-59.400744	112.20
17	56.80	68.20	120.355540	-43.996757	81.15
18	40.60	48.70	87.907437	-32.448103	58.72
19	28.70	34.65	63.839695	-24.067742	42.34
20	20.40	24.55	46.048293	-17.791401	30.38
21	14.90	17.65	33.318114	-12.730179	21.90
22	10.80	12.85	24.270439	-9.047675	15.91
23	7.40	9.10	17.462710	-6.807730	11.42
24	4.00	5.70	11.740641	-5.722068	7.67
25	1.10	2.55	6.624660	-5.115981	4.32
26	0.00	0.55	2.855888	-3.768772	1.86
27	0.00	0.00	0.996217	-1.859671	0.65
28	0.00	0.00	0.347880	-0.648337	0.23
29	0.00	0.00	0.121525	-0.226355	0.08

Tabla 124: Cálculos del Tránsito de Avenidas para L=300m

c) Gráfico



Gráfico 58: Gráfico de Caudal de Entrada vs Caudal Laminado para L=300m

4.6.1.1.13. Aliviadero L=325

a) Coeficientes

L	a	b	c	d
325	-0.00000003	0.0002	0.6901	5E-10

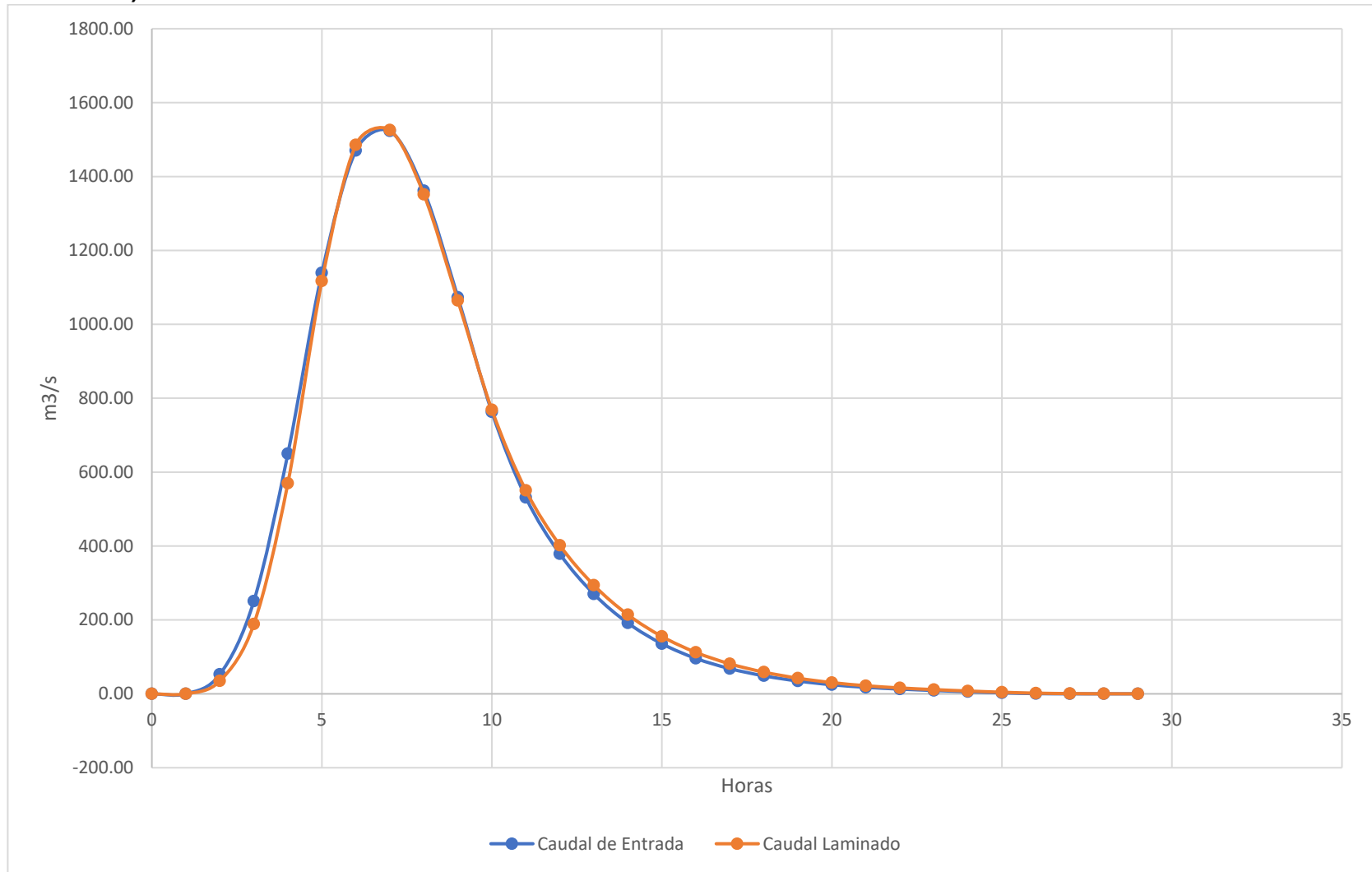
Tabla 125: Coeficientes de línea de tendencia para L=325m

b) Cálculos

T	I (m3/s)	I MEDIO	N	DELTA N	Q
0	0.00	-	0.000000		0.00
1	0.00	0.00	0.000000	0.000000	0.00
2	105.50	52.75	52.750000	52.750000	36.95
3	396.60	251.05	266.845116	214.095116	197.82
4	903.20	649.90	718.924070	452.078954	588.35
5	1374.90	1139.05	1269.621522	550.697452	1137.16
6	1565.40	1470.15	1602.614514	332.992992	1496.16
7	1481.20	1523.30	1629.758951	27.144437	1526.05
8	1241.80	1361.50	1465.204230	-164.554721	1346.14
9	904.30	1073.05	1192.118147	-273.086083	1056.08
10	621.20	762.75	898.783485	-293.334662	760.03
11	441.30	531.25	670.002087	-228.781398	543.13
12	316.00	378.65	505.526062	-164.476026	396.10
13	224.10	270.05	379.476922	-126.049139	289.04
14	159.10	191.60	282.038723	-97.438200	209.87
15	112.10	135.60	207.767682	-74.271041	151.74
16	79.60	95.85	151.872787	-55.894896	109.32
17	56.80	68.20	110.757398	-41.115389	78.85
18	40.60	48.70	80.611038	-30.146360	56.91
19	28.70	34.65	58.347447	-22.263590	40.94
20	20.40	24.55	41.956948	-16.390499	29.30
21	14.90	17.65	30.302597	-11.654351	21.09
22	10.80	12.85	22.057960	-8.244637	15.32
23	7.40	9.10	15.838773	-6.219187	10.98
24	4.00	5.70	10.558382	-5.280391	7.31
25	1.10	2.55	5.799782	-4.758600	4.01
26	0.00	0.55	2.340631	-3.459151	1.62
27	0.00	0.00	0.724266	-1.616365	0.50
28	0.00	0.00	0.224345	-0.499921	0.15
29	0.00	0.00	0.069515	-0.154831	0.05

Tabla 126: Cálculos del Tránsito de Avenidas para L=325m

c) Gráfico



Gráfico 59: Gráfico de Caudal de Entrada vs Caudal Laminado para L=325m

4.6.1.1.14. Aliviadero L=350

a) Coeficientes

L	a	b	c	d
350	-0.00000003	0.0002	0.7275	4E-10

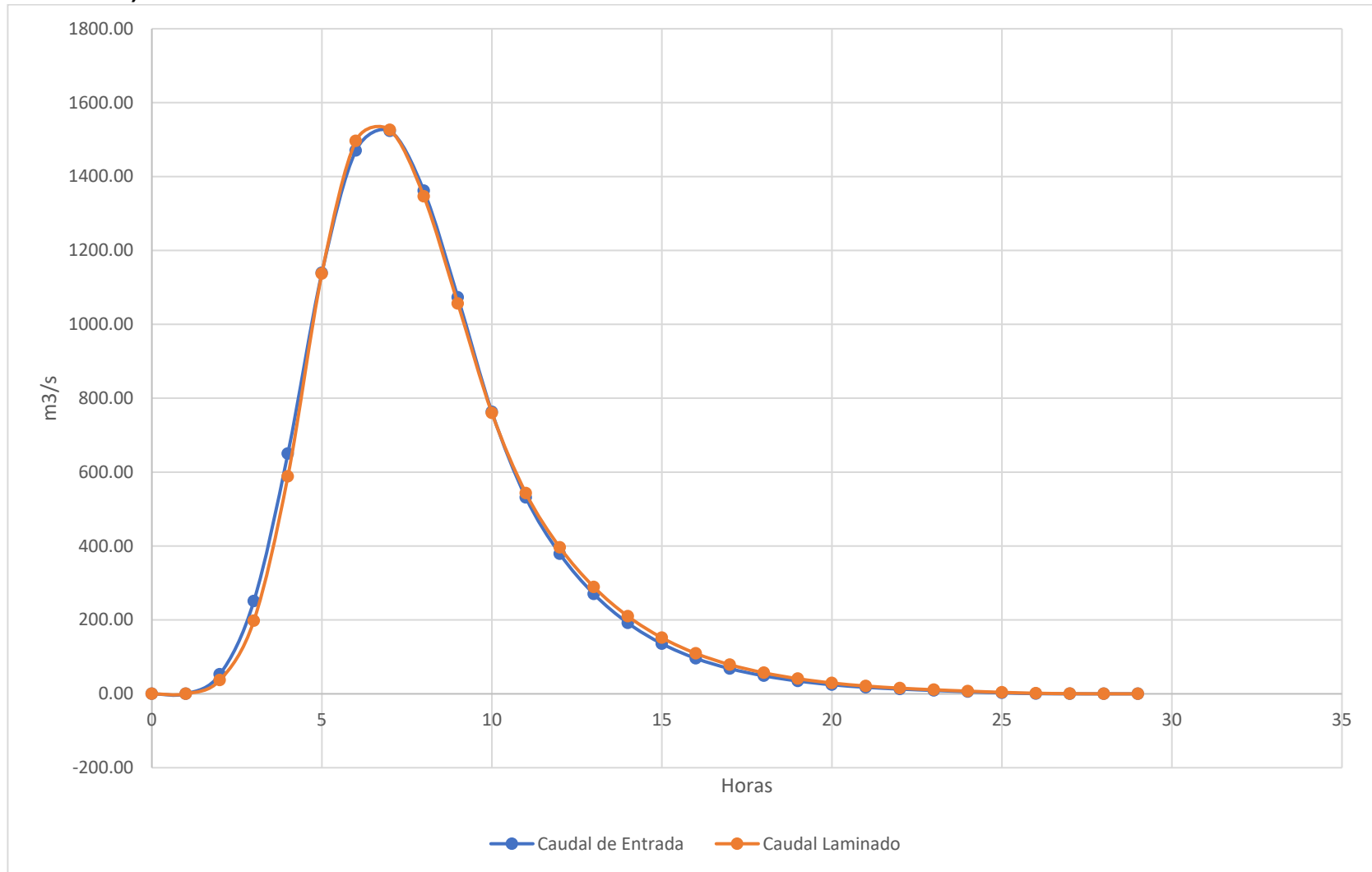
Tabla 127: Coeficientes de línea de tendencia para L=350m

b) Cálculos

T	I (m3/s)	I MEDIO	N	DELTA N	Q
0	0.00	-	0.000000		0.00
1	0.00	0.00	0.000000	0.000000	0.00
2	105.50	52.75	52.750000	52.750000	38.93
3	396.60	251.05	264.872266	212.122266	206.17
4	903.20	649.90	708.603711	443.731445	605.26
5	1374.90	1139.05	1242.394774	533.791063	1155.02
6	1565.40	1470.15	1557.524380	315.129606	1504.92
7	1481.20	1523.30	1575.900075	18.375695	1525.75
8	1241.80	1361.50	1411.651155	-164.248920	1341.14
9	904.30	1073.05	1143.565559	-268.085596	1048.63
10	621.20	762.75	857.687845	-285.877714	752.17
11	441.30	531.25	636.772437	-220.915408	536.60
12	316.00	378.65	478.820600	-157.951837	390.90
13	224.10	270.05	357.968144	-120.852456	284.67
14	159.10	191.60	264.894195	-93.073949	206.19
15	112.10	135.60	194.307501	-70.586693	148.69
16	79.60	95.85	141.467798	-52.839704	106.84
17	56.80	68.20	102.832284	-38.635514	76.89
18	40.60	48.70	74.639524	-28.192760	55.40
19	28.70	34.65	53.887533	-20.751990	39.78
20	20.40	24.55	38.658274	-15.229259	28.42
21	14.90	17.65	27.887220	-10.771054	20.44
22	10.80	12.85	20.294379	-7.592842	14.85
23	7.40	9.10	14.548097	-5.746282	10.63
24	4.00	5.70	9.622119	-4.925977	7.02
25	1.10	2.55	5.153537	-4.468582	3.75
26	0.00	0.55	1.949031	-3.204506	1.42
27	0.00	0.00	0.530351	-1.418680	0.39
28	0.00	0.00	0.144465	-0.385887	0.11
29	0.00	0.00	0.039362	-0.105102	0.03

Tabla 128: Cálculos del Tránsito de Avenidas para L=350m

c) Gráfico



Gráfico 60: Gráfico de Caudal de Entrada vs Caudal Laminado para L=350m

4.7. Longitud de Aliviadero

Se diseñará un aliviadero de 3 metro de altura y de longitud por definir.

Para la definir la longitud del aliviadero se elegirá la longitud que genere un menor pico máximo del caudal de salida o laminación.

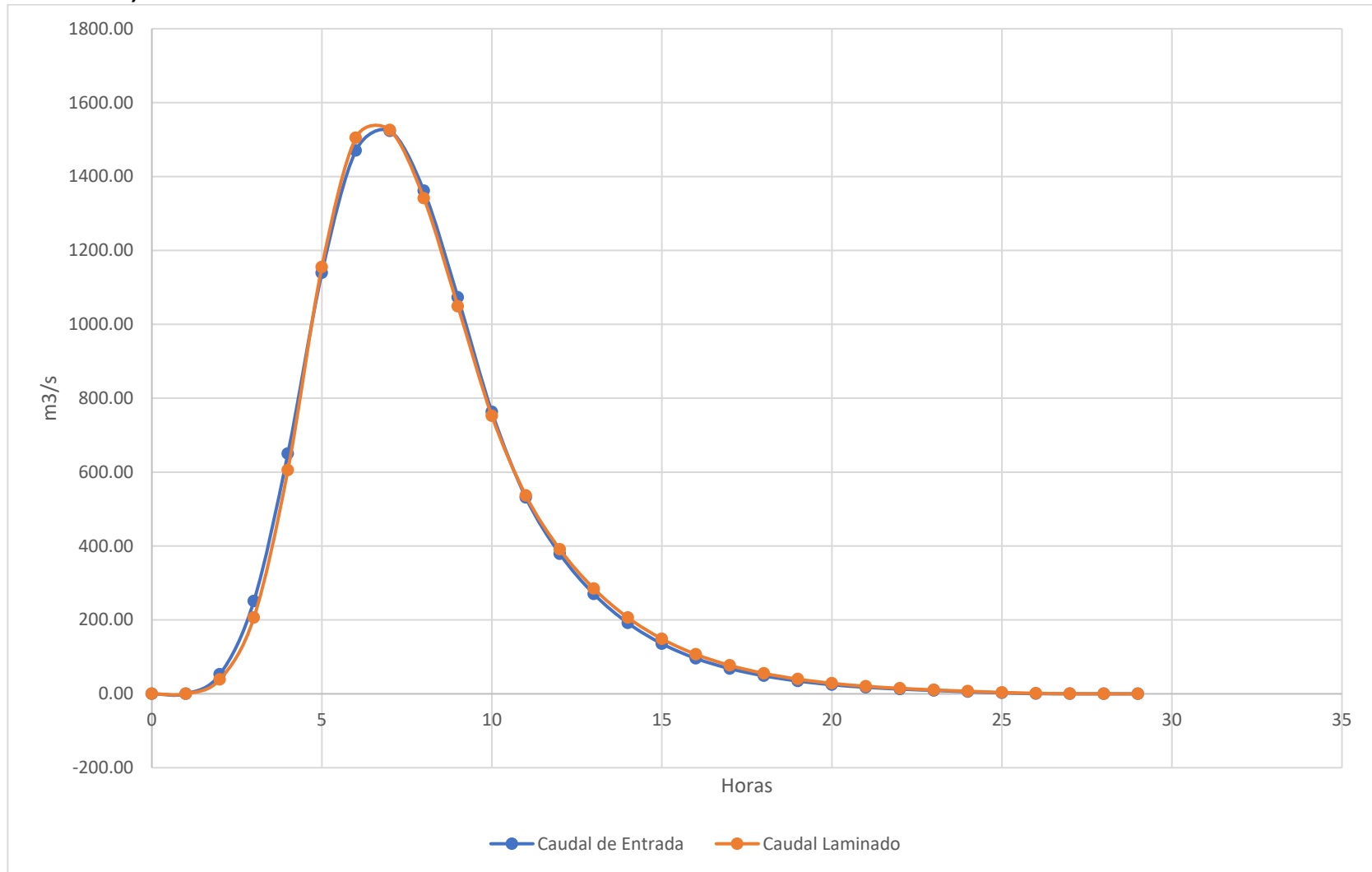
4.7.1. Cuadro Resumen

L(m)	Q _{máx} Laminado (m ³ /s)
25	-
50	1161.68
75	1288.56
100	1198.64
125	1513.78
150	1520.56
175	1526.18
200	1525.41
225	1524.18
250	1513.06
275	1524.90
300	1525.85
325	1526.05
350	1525.75
Mínimo	1161.68

Tabla 129: Cuadro Resumen del Q_{máx} Laminado

Definimos que la longitud del aliviadero que genera una mayor laminación es la de L= 50 metros con un caudal máximo laminado de 1161.68 m³/s.

4.8. Ancho de la Corona

$$Lc \text{ Norma Japonesa} = 3.6 * \sqrt[3]{H} - 3$$

$$Lc \text{ Norma Española} = 1.5 * (3 + 1.5 \sqrt[3]{H - 15})$$

$$Lc \text{ Buren of Reclamation} = 1 + 1.1 \sqrt{H}$$

ANCHO DE LA CORONA	
Altura de la presa	32.00 m
Lc Japonesa	8.43 m
Lc Española	10.29 m
Lc Bureu	7.22 m
PROMEDIO	8.65 m

Tabla 130: Ancho de la Corona en diferentes métodos

Se calcula un ancho de corona promedio de 8.65 metros, redondeado sería un ancho de 9.00 metros.

4.9. Borde Libre

$$Bl = 0.03 * H$$

Se calcula un borde libre de 0.96 metros, redondeado sería un borde libre de 1.00 metro.

4.10. Espaldones

Pendientes recomendadas de los taludes				
Tipo de presa	Tipo de suelo en el terraplen		Pendiente del talud	
	Espaldones	Núcleo	Aguas arriba	Aguas abajo
Zonificada	Roca, GW, GP, SW o SP (gravosas)	GC, GM, SC, SM, CL, ML, CH, MH.	2 : 1	2 : 1
Homogénea	Roca, GW, GP, SW, SP, GC, GM, SC, SM, CL, ML, CH, MH.		2:1	2:1
			2-3:1	2:1
			3,5:1	2,5:1
			4:1	2,5:1

Tabla 131: Pendientes recomendadas de los Taludes para los Espaldones

La propuesta es de una presa con núcleo impermeable, la cual tendrá pendiente de talud aguas arriba de 2:1 y pendiente de talud aguas abajo de 2:1.

4.11. Núcleo Impermeable

4.11.1. Base del Núcleo Impermeable

$$E_{min} = \frac{1}{3} \cdot h_{max}$$

Dónde:

$$h_{max} = H - Bl$$

$$h_{max} = 32 - 1$$

$$h_{max} = 31 \text{ metros}$$

$$E_{min} = 10.33 \cong 10 \text{ metros}$$

4.11.2. Corona del Núcleo Impermeable

Dimensión mínima en la corona es de 3 metros, optaremos por esta longitud.

4.11.3. Talud del Núcleo Impermeable

El talud de núcleo impermeable es de 0.25:1.00 (H:V).

4.12. Cuerpo Estabilizador

Está compuesta por bloques de tamaño promedio de 24", con esto se pretende cumplir con el criterio de permeabilidad que establece que debe ir de más a menos desde la parte externa de la presa hacia la zona del núcleo.

4.12.1. Talud del Cuerpo estabilizador

El talud del cuerpo estabilizador es de 2.50:1.00 (H:V).

4.13. Filtros

- Evitan la tubificación a través del cuerpo de la presa, ya que los espaldones son porosos.
- El filtro en aguas arriba proporciona protección contra el vaciado rápido y el de aguas abajo evita una posible erosión.
- Se recomienda usar filtros de espesor mínimo de 3.00 metros, optaremos por seguir esta recomendación.

4.14. Dren

-La función del dren es la de recoger el agua que por alguna razón pudiera atravesar el núcleo de material arcilloso y conducirla aguas abajo a través de su cuerpo permeable, evitando la tubificación del espaldón aguas abajo y previniendo el fallo de la presa.

- Tendrá un espesor de 3.00 metros aproximadamente.

4.15. Sección Transversal de la Presa de Tierra con Núcleo de Arcilla
4.15.1. Zonificación



Ilustración 76: Sección Transversal de Presa con Núcleo Impermeable de Arcilla

Número	Zona
1	Núcleo de Arcilla
2	Espaldones Aguas Abajo y Aguas Arriba
3	Cuerpo Estabilizador
4	Filtro
5	Dren

Tabla 132: Zonas de la sección transversal

4.15.3. Materiales

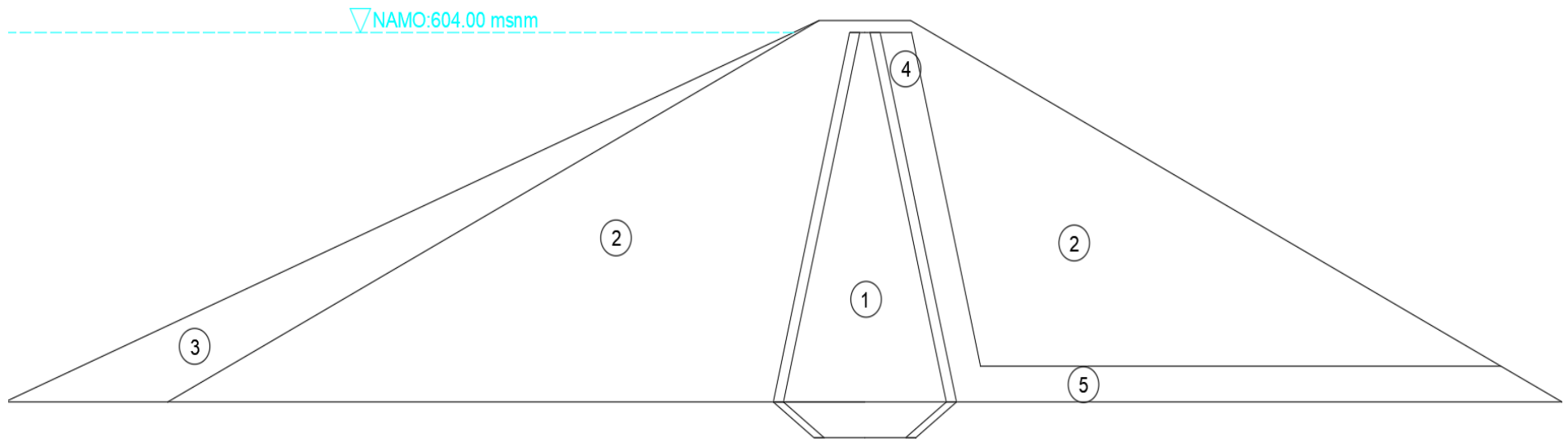

Ilustración 78: Materiales de la Presa Impermeable con Núcleo de Arcilla

SOMBREADADO	TIPO DE SUELO
1	Arcilla
2	Grava
3	Grava
4	Grava
5	Grava de mayor diámetro a 24"

Ilustración 79: Materiales usado según zona de la Presa Impermeable con Núcleo de Arcilla

CONCLUSIONES

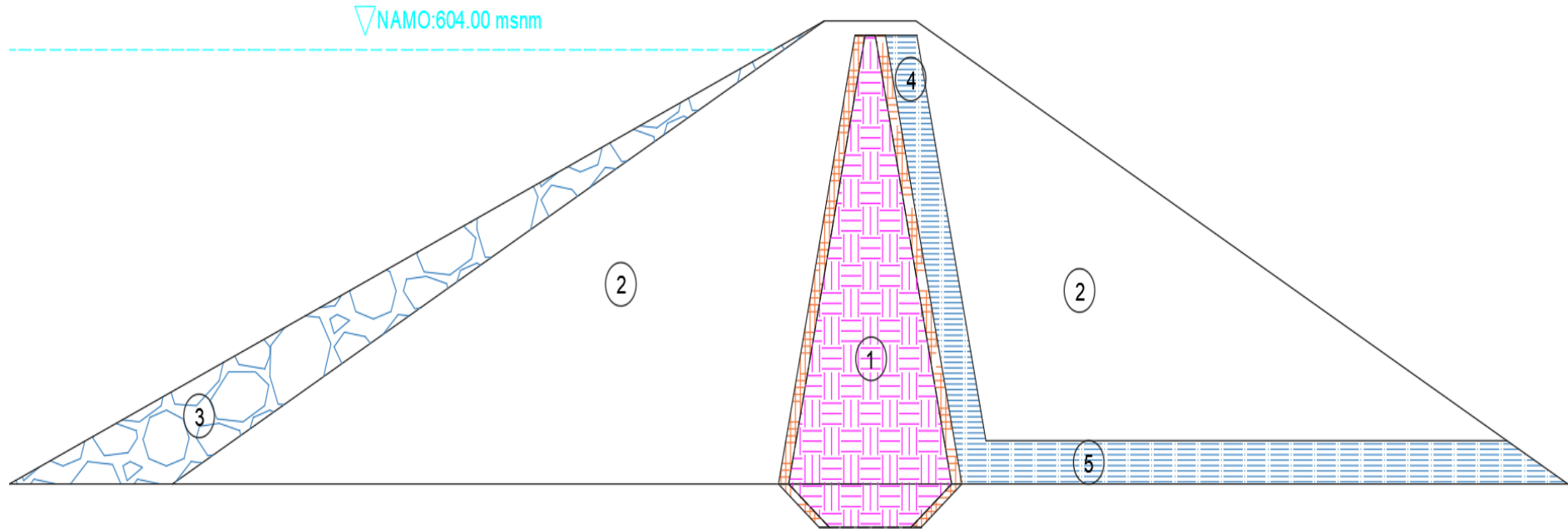
Del levantamiento topográfico se pudo hallar 3 posibles ubicaciones para nuestra presa, por medio del software Arc Map y realizando los cálculos de la Curva Cota-Área-Volumen se obtuvieron los volúmenes acumulados para los embalses, siendo 25.71 MMC para la primera propuesta de embalse, 16.88 MMC para la segunda propuesta y 18.69 MMC para la tercera propuesta.

Del análisis de caudales, después de recopilar el registro de caudales diarios de 48 años (Año 1971 al Año 2018), pudimos llegar a la conclusión que el caudal promedio diario durante ese periodo de tiempo fue de 286.08 (m³/s), una máxima de 1416.73 (m³/s) ocurrida en el año 1998 y una mínima de 37.24 (m³/s) ocurrida en el año 1980.

Respecto al cálculo del caudal de entrada pudimos obtener un caudal pico de 1565.40 (m³/s), esto calculado para un periodo de retorno de 100 años.

Las características de la presa de la propuesta que elegimos como la opción más favorable es la que en su embalse puede almacenar un volumen de 25.71 MMC, con una presa de longitud 366.91 metros, una altura de 32 metros, un aliviadero de longitud igual a 50 metros, con 9 metros en el ancho de la corona y una altura de 3 metros, consiguiendo una laminación de 1161.68 (m³/s).

La presa será de tierra con núcleo de arcilla o material impermeable, con espaldones de talud 2:1 (H:V) tanto en aguas arriba como en aguas abajo.

BIBLIOGRAFÍA:

- Pinto D., R. (2016). *DRONES: LA TECNOLOGÍA, VENTAJAS Y SUS POSIBLES APLICACIONES*. Obtenido de <https://www.sonami.cl/v2/wp-content/uploads/2016/03/09.-Drones-La-tecnologia-ventajas-y-sus-posibles-aplicaciones.pdf>
- Agisoft. (2019). *Agisoft*. Obtenido de <https://www.agisoft.com/>
- Aguas Altas*. (s.f.). Obtenido de <http://diccionario.raing.es/es/lema/aguas-altas>
- Alcántara Portal, V. F. (2015). *TOPOGRAFÍA CON ESTACIÓN TOTAL*. Obtenido de https://www.academia.edu/18645461/Topograf%C3%ADa_con_Estaci%C3%B3n_Total_-_Teor%C3%ADa_-_V_1_03
- Apacla, R. (2014). *Hidráulica Fluvial*. Lima: Universidad Nacional Agraria La Molina.
- Autodesk. (2018). *CIVIL 3D*. Obtenido de <https://knowledge.autodesk.com/es/support/civil-3d/learn-explore/caas/CloudHelp/cloudhelp/2016/ESP/Civil3D-UserGuide/files/GUID-A3BD33D2-CE8F-4859-BE70-8DE0408BD708-htm.html>
- Avenida*. (s.f.). Obtenido de [https://es.wikipedia.org/wiki/Avenida_\(hidrolog%C3%ADa\)#:~:text=Una%20avenida%20conocida%20en%20algunos,el%20flujo%20medio%20de%20este.](https://es.wikipedia.org/wiki/Avenida_(hidrolog%C3%ADa)#:~:text=Una%20avenida%20conocida%20en%20algunos,el%20flujo%20medio%20de%20este.)
- Botella, R., Alacreu, G., & Martínez, B. (s.f.). *Inferencia Estadística*. Obtenido de <https://www.uv.es/~mamtnz/IECRC.pdf>
- ESRI. (2016). *ESRI*. Obtenido de <https://www.esri.com/es-es/arcgis/products/arcgis-pro>
- Estuardo Morales, A. (2012). *Estadística y Probabilidades*. Obtenido de <http://www.x.edu.uy/inet/EstadisticayProbabilidad.pdf>
- Ferreira, M. (2017). *Aplicaciones Topográficas de los Drones*. Obtenido de <https://docplayer.es/46121284-Aplicaciones-topograficas-de-los-drones.html>
- FRANQUET BERNIS, J. M., & QUEROL GÓMEZ, A. (2010). *NIVELACIÓN DE TERRENOS POR REGRESIÓN TRIDIMENSIONAL*. Obtenido de <https://www.eumed.net/libros-gratis/2011b/967/967.zip>
- Grosche, C. (2010). *MEJORA DEL CAMINO CAN CABOT DE MUNT*. Obtenido de <https://upcommons.upc.edu/bitstream/handle/2099.1/10934/MEMORIA.pdf?sequence=1&isAllowed=y>
- INDECI. (2011). *Manual de Estimación del Riesgo ante Inundaciones Fluviales*. <http://bvpad.indeci.gob.pe/doc/pdf/esp/doc1743/doc1743-contenido.pdf>.
- MTC. (2015). *Manual de Hidrología, Hidráulica y Drenaje*. Obtenido de http://transparencia.mtc.gob.pe/idm_docs/P_recientes/970.pdf
- Niño, R., & Duarte, A. (2004). *Introducción a la Mecánica de Fluidos*. Universidad Nacional de Colombia.
- Pachas L., R. (2009). *EL LEVANTAMIENTO TOPOGRÁFICO: USO DEL GPS Y ESTACIÓN TOTAL*. Obtenido de <http://www.saber.ula.ve/bitstream/handle/123456789/30397/articulo3.pdf;jsessionid=F4C1826991CFEE7D3D05FF090B86AED8?sequence=1>

- Pérez, B., Rodríguez, A., & Molina, J. (2018). *Ingeniería de Ríos*. Obtenido de <http://hidraulica.umich.mx/bperez/APUNTES%20INGENIER%C3%8DA%20DE%20R%C3%8DOS-AGO-2018%20V-3.pdf>
- Poterr, M. (2015). *Mecánica de Fluidos (Cuarta Edi; Cengage Learning Editors, Ed.)*. México D.F.
- Rocha, A. (1998). *Introducción a la Hidráulica Fluvial*.
- Sánchez San Román, F. (2013). *Curvas de caudales clasificados* . Obtenido de Dpto Geología – Universidad de Salamanca (España) : http://hidrologia.usal.es/Complementos/Curvas_de_Q_clasificados.pdf
- Santana Cruz, E. (2017). *Propuesta de sistema multi-UAV para aplicaciones de cobertura de área*.
- Swanston, G. (2006). Topografía: Mensaje gráfico geoespacial. En *Universidad Central de Venezuela* (págs. pag. 159, 464,160- 164,171, 466,413).
- Vide, J. (2002). *Ingeniería de Ríos*. Barcelona: UPC.
- Villón Béjar, M. (2016). *Hidrología Estadística*. Lima: Instituto Tecnológico de Costa Roca, Escuela de Ingeniería Agrícola.

ANEXOS

REGISTRO DE DESCARGA DIARIA														
RIO CHICAMA			AÑO 1971						ESTACIÓN SALINAR					TOTAL
Día	Enero	Febrero	Marzo	Abril	Mayo	Junio	Julio	Agosto	Septiembre	Octubre	Noviembre	Diciembre		
1	7,001	17,565	38,546	260,992	32,624	11,520	7,312	4,000	4,384	5,904	8,576	5,440	403,864	
2	6,466	14,593	34,011	286,432	32,624	10,944	7,184	4,000	4,284	5,028	7,756	8,844	422,166	
3	6,466	13,125	41,062	244,048	28,816	10,736	7,024	3,872	4,128	4,912	7,820	10,400	382,409	
4	6,202	11,147	41,062	151,760	27,088	10,688	7,104	3,856	4,028	4,800	7,272	8,924	283,931	
5	7,266	10,636	74,973	137,328	26,272	10,880	6,864	3,776	3,924	5,024	6,624	8,076	301,643	
6	13,866	9,879	85,056	106,928	25,856	10,416	6,864	3,760	4,028	7,152	5,880	7,404	287,089	
7	19,800	9,879	53,690	100,384	25,232	10,384	6,816	3,696	4,028	5,968	5,760	6,500	252,137	
8	18,547	8,830	89,112	86,928	23,872	10,464	6,464	4,016	4,232	6,272	5,168	6,360	270,265	
9	16,091	8,318	66,357	79,344	22,880	10,544	6,368	3,952	4,028	5,568	5,640	5,732	234,822	
10	14,347	8,058	53,690	65,120	22,272	10,512	6,096	4,464	4,232	6,272	4,976	5,516	205,555	
11	11,892	7,001	51,171	77,088	23,760	10,624	5,792	4,448	5,500	5,560	4,528	4,940	212,304	
12	10,891	6,734	56,209	59,952	22,832	12,320	5,472	4,560	5,216	5,088	4,368	4,620	198,262	
13	10,636	6,202	91,663	108,176	21,440	12,432	5,168	5,364	5,444	4,864	7,716	4,392	283,497	
14	9,626	6,202	128,091	115,392	19,968	12,256	5,152	4,992	5,792	6,400	6,660	3,968	324,499	
15	9,626	5,400	121,263	86,960	18,352	11,680	5,120	5,792	5,184	10,404	7,432	3,764	290,977	
16	9,626	5,400	152,979	78,960	18,000	12,344	5,200	5,280	4,828	9,724	6,408	3,664	312,413	
17	9,626	6,734	171,143	78,464	17,680	10,912	5,088	5,456	4,720	7,840	5,680	3,564	326,907	
18	9,626	14,593	205,563	64,832	16,912	10,608	4,832	5,376	4,500	7,304	5,448	3,272	352,866	
19	9,104	33,551	340,794	60,960	16,032	10,272	4,608	4,768	4,284	7,212	4,948	3,264	499,797	
20	8,578	42,339	396,969	55,824	15,936	9,968	4,608	4,756	4,180	7,040	4,548	10,644	565,390	
21	7,532	71,412	345,760	57,696	15,008	9,664	4,592	4,704	3,868	7,088	4,576	9,616	541,516	
22	6,733	76,500	405,018	50,096	15,008	9,168	4,592	4,608	3,868	7,356	5,216	11,584	599,747	
23	6,202	101,719	427,088	50,032	14,784	8,752	4,592	4,496	3,360	7,572	7,432	10,724	646,753	
24	6,202	101,719	401,728	47,792	14,400	8,512	4,304	5,008	3,520	7,224	6,784	10,604	617,797	
25	5,940	56,236	193,000	48,576	15,760	8,064	4,160	4,832	3,520	7,160	5,800	11,424	364,472	
26	5,940	60,792	190,368	50,208	15,624	7,792	4,144	4,800	3,520	7,224	5,000	26,688	382,100	
27	5,940	61,302	296,064	47,472	14,256	7,632	3,984	4,832	3,520	7,620	4,440	21,920	478,982	
28	5,940	41,062	191,334	37,840	13,632	7,760	4,000	4,656	3,440	8,576	4,604	21,344	344,188	
29	5,940		123,040	36,476	12,896	7,520	3,932	4,444	4,072	10,476	4,584	19,456	232,836	
30	8,318		92,480	32,576	12,432	7,344	4,000	4,432	7,024	8,580	4,440	19,472	201,098	
31	26,041		107,472		12,000		4,000	4,444		8,580		18,864	181,401	
PROMEDIO DIARIO (L/S)													354,893	

Ilustración 80: Registro de Descarga Diaria del Año 1971

REGISTRO DE DESCARGA DIARIA														
RIO CHICAMA			AÑO 1972							ESTACIÓN SALINAR				TOTAL
Día	Enero	Febrero	Marzo	Abril	Mayo	Junio	Julio	Agosto	Septiembre	Octubre	Noviembre	Diciembre		
1	18,088	9,008	68,240	63,392	37,088	19,104	9,872	5,232	4,668	3,808	3,260	5,812	247,572	
2	16,416	9,552	72,240	62,860	35,536	18,282	10,128	5,072	4,448	3,712	3,104	5,712	247,062	
3	16,800	13,680	79,712	58,512	32,928	17,248	9,888	5,008	4,448	3,712	2,912	5,240	250,088	
4	43,888	10,992	270,016	59,104	32,928	16,752	9,504	5,136	4,448	3,702	2,912	6,576	465,958	
5	28,704	10,720	317,392	55,936	30,576	16,624	9,152	5,136	4,448	4,656	2,736	5,356	491,436	
6	23,404	9,984	179,184	58,528	28,720	16,176	8,608	5,136	4,448	4,560	2,736	5,356	346,840	
7	20,112	10,384	224,274	60,160	27,776	15,872	8,432	5,024	4,448	5,712	2,640	5,832	390,666	
8	16,896	41,840	228,288	55,168	28,976	15,808	8,080	4,848	4,448	5,712	2,472	5,592	418,128	
9	18,864	37,424	339,680	57,412	32,640	15,588	7,978	4,816	4,320	6,080	2,472	6,328	533,602	
10	17,472	81,984	510,112	58,240	27,856	14,880	7,776	4,736	4,320	5,472	2,472	9,356	744,676	
11	17,664	75,144	556,720	86,960	24,544	14,880	7,840	4,464	4,320	5,008	2,368	9,380	809,292	
12	20,736	44,896	345,408	70,272	27,280	14,576	8,128	4,336	4,320	4,650	2,368	9,040	556,010	
13	33,280	35,700	168,672	58,128	23,232	14,496	8,000	4,320	4,224	4,012	2,288	16,020	372,372	
14	24,838	30,368	116,480	74,800	27,120	14,048	7,972	4,304	4,224	3,912	2,648	15,648	326,362	
15	30,832	26,112	189,152	71,216	22,736	14,000	6,912	4,304	4,320	3,904	2,544	13,504	389,536	
16	27,728	21,280	124,640	65,024	22,848	14,000	6,912	4,304	4,320	3,808	2,454	13,600	310,918	
17	21,840	18,816	118,640	59,808	25,984	12,400	6,816	4,256	4,224	3,808	2,268	11,776	290,636	
18	18,624	16,592	113,168	62,560	22,800	13,088	6,736	4,032	4,224	3,696	2,268	25,152	292,940	
19	16,032	14,976	103,536	53,808	21,216	12,464	6,736	4,032	4,320	3,504	2,208	24,880	267,712	
20	14,880	14,048	516,512	53,040	19,440	12,336	6,736	4,032	4,640	3,504	2,148	17,840	669,156	
21	15,408	12,944	196,064	53,840	22,880	12,240	6,736	3,944	5,584	3,504	2,032	14,048	349,224	
22	14,656	12,720	134,800	51,776	20,400	12,480	6,592	3,944	5,584	3,504	2,032	11,072	279,560	
23	13,520	12,736	210,128	47,376	21,456	12,288	6,096	3,904	5,584	3,296	2,148	8,644	347,176	
24	12,816	13,760	150,656	46,064	24,256	11,808	6,064	3,904	4,732	3,296	2,212	8,224	287,792	
25	12,736	14,064	96,944	46,480	23,712	11,648	5,776	5,240	4,704	3,200	2,448	6,096	233,048	
26	11,728	17,792	88,928	42,912	23,584	11,312	5,280	4,560	4,480	3,112	5,008	5,120	223,816	
27	10,592	45,520	67,968	44,580	20,512	10,896	5,280	4,780	4,240	3,112	9,360	5,120	231,960	
28	9,008	53,680	61,680	44,080	22,816	10,448	5,280	5,008	4,000	3,296	8,016	5,008	232,320	
29	8,208	81,344	68,304	43,360	21,200	10,224	5,232	5,008	3,840	3,392	6,320	4,560	260,992	
30	8,032		69,184	44,576	21,056	10,112	5,232	4,896	3,840	3,392	5,892	4,132	180,344	
31	8,112		64,960		20,224		5,232	4,896		3,200		4,132	110,756	
PROMEDIO DIARIO (L/S)													359,934	

Ilustración 81: Registro de Descarga Diaria del Año 1972

REGISTRO DE DESCARGA DIARIA													
RIO CHICAMA			AÑO 1973						ESTACIÓN SALINAR				TOTAL
Día	Enero	Febrero	Marzo	Abril	Mayo	Junio	Julio	Agosto	Septiembre	Octubre	Noviembre	Diciembre	
1	4,020	30,416	74,288	169,184	89,920	26,832	15,552	9,840	4,864	7,924	7,892	8,570	449,302
2	3,904	26,832	76,656	182,984	97,088	26,208	15,392	9,472	4,704	7,356	9,176	8,160	467,932
3	3,712	23,968	90,336	301,264	92,488	25,712	15,472	9,376	4,704	7,256	10,324	8,300	592,912
4	3,392	28,512	75,072	382,864	80,192	25,664	15,264	9,360	4,656	7,272	12,336	7,777	652,361
5	3,308	54,736	65,504	267,232	88,560	24,320	15,106	9,328	4,800	7,256	14,544	7,510	562,204
6	3,016	56,640	62,624	228,160	80,200	24,000	15,120	9,328	5,232	6,864	13,728	6,830	511,742
7	2,832	100,048	128,000	466,688	76,976	23,040	14,944	9,232	5,504	7,256	14,176	6,320	855,016
8	3,208	86,832	108,752	307,560	72,512	20,912	14,912	9,096	6,032	7,388	14,928	6,200	658,332
9	4,232	74,872	147,552	307,008	68,320	20,912	14,672	8,672	5,840	7,924	10,096	5,710	675,810
10	8,876	54,632	161,792	260,192	64,288	21,024	13,408	8,592	5,760	8,060	14,496	5,590	626,710
11	31,792	54,160	102,528	339,008	66,768	20,464	13,436	8,592	5,360	8,908	13,264	5,240	669,520
12	22,816	62,816	134,528	434,592	64,648	19,144	13,408	7,616	5,520	9,776	11,984	5,160	792,008
13	25,536	54,608	103,184	355,392	61,984	19,184	13,072	7,552	5,520	8,028	11,428	5,230	670,718
14	32,160	42,848	151,170	402,432	58,608	18,400	12,640	6,752	5,520	7,224	10,080	5,100	752,934
15	47,616	35,904	141,464	317,760	53,456	18,128	12,208	6,448	5,284	7,224	9,036	5,120	659,648
16	58,240	31,528	121,200	246,384	49,024	17,548	11,680	6,388	5,280	7,072	9,036	5,710	569,090
17	60,880	28,992	105,152	297,312	45,920	16,960	11,120	6,256	5,872	7,332	8,440	9,710	603,946
18	78,032	28,992	101,872	298,704	40,784	16,560	10,160	5,968	6,612	9,116	8,028	9,500	614,328
19	101,334	25,584	120,992	97,184	38,824	16,352	10,784	5,136	7,516	13,896	8,876	9,580	456,058
20	118,224	24,416	95,952	185,581	38,644	16,416	10,084	5,104	7,252	15,588	10,324	9,710	537,295
21	88,944	22,800	73,248	153,584	35,392	17,808	10,000	5,296	8,324	21,232	9,296	10,320	456,244
22	71,024	20,560	72,576	137,072	34,688	18,128	10,032	5,456	9,036	16,912	9,176	14,320	418,980
23	69,424	26,160	70,704	104,992	34,528	16,880	10,032	5,564	9,036	15,408	9,036	18,740	390,504
24	87,920	26,128	86,592	130,352	34,096	16,464	9,904	5,648	9,740	13,392	8,720	26,060	455,016
25	80,016	26,128	68,384	114,832	29,440	16,464	9,808	5,600	10,760	11,728	8,720	26,510	408,390
26	74,016	25,776	77,408	117,072	29,536	16,304	9,744	5,600	10,800	11,056	9,880	19,870	407,062
27	57,520	31,792	72,594	109,008	28,576	16,432	9,504	5,504	10,823	10,224	10,804	17,870	380,651
28	55,920	44,864	78,304	103,824	27,760	16,416	9,408	5,344	10,832	9,024	12,016	24,510	398,222
29	49,072		90,016	90,464	28,704	16,608	9,408	5,232	9,580	8,304	10,120	18,280	335,788
30	41,648		81,536	81,120	28,640	15,648	9,104	5,088	8,720	7,836	9,036	17,800	306,176
31	35,152		109,408		27,504		9,120	4,828		7,620		22,990	216,622
PROMEDIO DIARIO (L/S)													533,920

Ilustración 82: Registro de Descarga Diaria del Año 1973

REGISTRO DE DESCARGA DIARIA														
RIO CHICAMA			AÑO 1974							ESTACIÓN SALINAR				TOTAL
Día	Enero	Febrero	Marzo	Abril	Mayo	Junio	Julio	Agosto	Septiembre	Octubre	Noviembre	Diciembre		
1	22,128	33,296	84,080	41,744	20,864	7,888	8,586	4,520	3,630	4,890	3,380	4,920	239,926	
2	31,488	37,280	141,688	43,104	20,288	7,888	8,256	4,410	4,800	6,470	3,380	4,920	313,972	
3	27,220	31,392	182,704	37,568	19,696	7,872	8,190	4,410	4,240	5,400	3,380	4,120	336,192	
4	22,224	25,776	192,400	34,512	18,784	7,840	8,128	4,090	3,870	4,700	3,260	3,680	329,264	
5	18,928	22,768	127,792	29,536	18,016	8,016	8,110	3,980	3,600	4,170	3,000	3,080	250,996	
6	18,960	25,600	122,192	26,704	17,072	7,968	7,400	3,980	3,480	4,170	2,870	2,920	243,316	
7	19,360	23,960	118,736	28,336	16,384	7,728	7,082	3,980	3,350	4,060	2,770	2,600	238,346	
8	20,192	44,960	85,104	28,404	15,568	8,000	6,896	3,870	3,350	4,070	2,960	2,600	225,974	
9	20,336	60,560	68,816	28,144	15,072	8,176	6,700	4,050	3,200	4,070	2,880	2,600	224,604	
10	22,096	68,400	61,616	26,928	13,888	8,080	6,700	4,300	3,200	5,400	2,880	2,660	226,148	
11	26,400	52,912	52,896	27,696	12,480	8,128	6,600	4,300	3,000	6,240	2,680	2,320	205,652	
12	29,760	46,448	58,384	27,552	12,400	8,240	6,060	4,060	2,900	5,290	2,500	2,240	205,834	
13	37,712	38,912	56,416	26,640	12,240	8,608	5,610	3,800	2,760	5,290	2,400	2,060	202,448	
14	47,552	34,960	50,448	26,032	12,144	8,832	5,480	3,600	2,700	4,600	2,400	2,060	200,808	
15	60,624	31,248	50,224	26,304	11,712	8,560	5,230	3,800	2,700	4,280	2,490	2,060	209,232	
16	37,936	38,080	42,272	30,288	11,552	8,368	4,944	3,800	2,600	4,060	2,590	2,140	188,630	
17	34,640	46,546	42,272	50,992	11,280	8,160	4,820	3,800	2,800	3,850	2,590	2,060	213,810	
18	26,752	80,544	42,048	46,672	10,480	8,080	4,800	3,800	2,720	3,490	3,660	2,240	235,286	
19	20,528	77,536	43,108	35,552	9,904	8,032	4,860	3,630	2,720	3,710	3,260	2,600	215,440	
20	19,808	142,320	36,832	31,104	9,824	7,840	4,860	3,630	2,600	5,520	2,960	2,870	270,168	
21	18,784	189,744	36,208	36,208	9,824	8,272	4,860	3,630	2,400	9,380	2,870	5,150	327,330	
22	17,520	185,104	35,968	26,336	10,016	7,952	4,880	3,310	2,400	5,840	2,590	5,150	307,066	
23	15,760	128,944	34,336	26,560	9,984	7,936	5,000	3,200	2,340	5,800	2,360	4,760	246,980	
24	15,008	94,848	34,304	23,632	9,504	7,936	6,000	3,000	2,340	5,800	2,360	5,630	210,362	
25	13,904	72,640	34,576	20,736	9,216	8,576	5,620	3,000	2,500	5,320	2,590	6,510	185,188	
26	13,152	60,912	35,904	20,192	8,544	8,768	5,440	2,930	2,660	4,630	2,320	6,900	172,352	
27	12,896	60,144	34,336	18,944	8,500	8,816	5,310	2,930	2,850	4,100	2,240	6,900	167,966	
28	13,680	77,136	34,368	20,864	8,144	9,264	4,860	2,930	2,720	4,100	2,060	5,750	185,876	
29	13,184		44,480	20,048	8,128	8,912	4,860	2,770	2,720	4,040	2,600	4,920	116,662	
30	13,024		48,960	20,448	8,176	8,608	4,860	2,769	2,900	3,560	4,920	4,570	122,795	
31	14,784		50,848		8,064		4,740	3,180		3,380		4,200	89,196	
PROMEDIO DIARIO (L/S)													222,833	

Ilustración 83: Registro de Descarga Diaria del Año 1974

REGISTRO DE DESCARGA DIARIA														
RIO CHICAMA			AÑO 1975							ESTACIÓN SALINAR				TOTAL
Día	Enero	Febrero	Marzo	Abril	Mayo	Junio	Julio	Agosto	Septiembre	Octubre	Noviembre	Diciembre		
1	4,570	7,100	406,900	107,152	37,728	15,808	8,464	5,968	10,000	9,000	10,000	6,200	628,890	
2	5,150	7,510	226,300	96,816	36,928	15,616	8,800	5,952	8,636	9,630	11,728	5,800	438,866	
3	4,850	13,240	250,800	104,272	40,832	16,144	8,976	5,920	7,788	10,388	12,032	5,440	480,682	
4	4,800	16,220	212,192	135,093	40,304	18,432	8,928	5,824	6,852	8,000	10,840	5,110	472,595	
5	6,820	17,500	155,472	204,300	37,584	18,592	8,860	5,808	6,336	8,064	10,048	4,880	484,264	
6	5,570	31,520	167,152	153,570	43,200	17,376	8,672	5,472	5,804	7,520	9,920	4,500	460,276	
7	5,320	32,780	129,900	102,840	35,536	17,520	8,192	5,832	5,200	6,928	9,240	4,430	363,718	
8	6,610	22,260	107,968	212,750	31,680	17,600	7,728	5,956	4,968	6,500	8,500	4,396	436,916	
9	6,320	16,020	107,248	157,320	31,680	17,536	7,700	5,900	4,884	6,280	7,960	4,340	373,188	
10	6,370	13,410	119,312	150,544	30,784	16,640	7,600	5,900	4,656	6,200	7,568	4,170	373,154	
11	6,050	12,910	91,680	127,824	29,616	15,216	7,456	5,896	4,596	8,640	6,780	4,100	320,764	
12	6,430	13,880	106,784	128,144	29,760	14,192	7,392	5,712	4,540	9,710	6,560	4,112	337,216	
13	7,470	15,080	117,392	115,152	29,664	13,872	7,296	5,592	4,500	10,380	5,860	4,060	336,318	
14	9,050	20,790	127,600	134,112	29,488	12,650	7,296	5,532	4,484	18,000	6,120	3,748	378,870	
15	20,140	18,530	148,200	89,056	29,320	11,648	7,296	5,652	4,428	21,536	8,100	3,724	367,630	
16	38,038	18,056	205,730	78,368	26,112	11,344	7,500	5,472	4,768	21,160	7,764	3,564	427,876	
17	26,480	14,840	206,890	76,143	23,976	11,360	7,520	5,356	5,340	32,504	7,100	3,424	420,933	
18	22,610	16,700	292,810	72,768	24,480	11,168	7,390	5,124	5,952	25,600	7,100	3,400	495,102	
19	21,230	66,864	207,380	64,369	23,040	10,720	7,264	5,064	5,712	23,712	6,616	3,780	445,751	
20	22,030	77,568	223,600	59,850	20,496	10,160	7,200	5,064	5,904	25,424	6,088	3,992	467,376	
21	18,048	66,320	311,660	50,435	21,328	9,540	6,988	4,968	5,790	24,880	8,200	4,044	532,201	
22	17,160	69,800	267,630	54,351	20,336	9,360	6,848	4,848	6,464	23,712	10,800	4,100	495,409	
23	17,720	98,400	220,385	52,201	18,592	9,056	6,848	4,800	6,840	21,392	10,964	4,736	471,934	
24	17,540	74,670	173,140	46,236	18,120	9,008	6,464	4,800	7,776	19,440	10,844	4,624	392,662	
25	14,950	70,510	236,210	41,632	17,808	9,152	6,352	5,080	8,336	17,184	10,696	4,428	442,338	
26	12,320	110,240	176,970	43,200	17,336	8,976	6,128	5,592	9,760	14,816	10,500	4,176	420,014	
27	11,350	134,900	147,225	41,776	16,624	9,024	6,000	6,672	10,080	13,148	9,640	3,748	410,187	
28	10,160	245,936	115,852	44,132	16,384	8,840	6,000	9,652	10,124	13,148	8,200	3,672	492,100	
29	9,330		112,769	46,256	16,336	8,560	6,000	10,000	10,080	12,288	7,084	3,468	242,171	
30	7,830		96,808	37,232	16,016	8,368	6,000	8,700	9,712	10,848	6,680	3,332	211,526	
31	7,140		101,336		15,728		6,128	10,000		9,520		3,328	153,180	
PROMEDIO DIARIO (L/S)													412,068	

Ilustración 84: Registro de Descarga Diaria del Año 1975

REGISTRO DE DESCARGA DIARIA														
RIO CHICAMA			AÑO 1976							ESTACIÓN SALINAR				TOTAL
Día	Enero	Febrero	Marzo	Abril	Mayo	Junio	Julio	Agosto	Septiembre	Octubre	Noviembre	Diciembre		
1	3,968	70,096	132,640	58,364	24,128	11,888	6,528	4,992	3,808	2,924	2,928	2,212	324,476	
2	4,940	62,288	174,080	54,880	25,104	11,520	5,872	4,800	3,696	2,832	3,016	2,048	355,076	
3	5,168	55,728	256,016	50,784	24,864	11,580	5,792	4,688	3,808	2,880	3,208	2,212	426,728	
4	4,608	52,112	204,304	44,612	26,096	12,960	5,824	4,624	3,696	3,008	3,404	2,474	367,722	
5	4,720	47,440	182,560	40,832	25,456	12,190	5,632	4,689	3,600	2,832	3,392	3,404	336,747	
6	5,872	47,248	129,568	36,576	25,056	10,696	5,568	4,672	3,504	2,816	3,208	3,708	278,492	
7	11,144	43,416	84,288	36,048	23,824	10,464	5,476	4,896	3,600	2,720	3,016	3,696	232,588	
8	13,984	39,024	68,928	43,968	22,880	10,416	5,476	4,688	3,600	2,464	2,736	3,308	221,472	
9	15,107	34,512	60,624	47,056	22,272	10,736	5,424	4,704	3,600	2,560	2,600	2,924	212,119	
10	16,576	31,136	53,952	41,056	20,480	10,960	5,296	4,688	3,504	2,564	2,472	3,000	195,684	
11	17,168	40,068	61,728	39,456	19,584	13,108	5,248	4,672	3,392	2,640	2,296	3,004	212,364	
12	16,704	35,888	66,832	49,824	18,432	12,576	5,328	4,688	3,392	2,924	2,288	2,552	221,428	
13	14,576	35,168	65,104	58,160	17,152	11,728	5,264	4,656	3,296	2,648	2,384	2,464	222,600	
14	14,384	35,296	65,824	68,706	16,480	11,232	5,212	4,672	3,392	2,656	2,400	2,552	232,806	
15	13,040	35,664	68,560	70,864	15,664	10,880	5,200	4,688	3,296	2,832	2,296	2,292	235,276	
16	27,680	33,414	62,480	62,336	15,924	10,288	5,040	4,672	3,208	2,848	2,368	2,208	332,466	
17	23,552	32,400	58,476	56,064	15,152	9,664	4,736	4,642	3,112	2,656	2,348	2,044	214,846	
18	18,800	31,536	46,416	49,968	14,576	8,736	4,720	4,656	3,112	2,648	2,212	2,832	190,212	
19	20,128	28,592	46,288	37,120	14,560	8,560	4,672	4,640	2,928	2,672	2,296	2,472	174,928	
20	21,440	29,136	44,388	36,440	14,448	8,336	4,624	4,528	3,208	2,560	2,272	2,296	173,676	
21	23,392	41,184	52,608	32,640	14,452	7,924	4,528	4,416	3,208	2,464	2,128	2,268	191,212	
22	26,336	85,440	68,032	37,568	14,028	7,840	5,580	4,288	3,016	2,448	2,044	2,160	258,780	
23	37,760	81,088	68,432	34,384	14,080	7,600	5,584	4,176	2,712	2,384	2,032	1,916	262,148	
24	68,176	94,352	68,384	33,168	13,856	7,616	5,472	4,000	2,628	2,972	1,874	2,728	305,226	
25	46,432	111,568	68,256	35,024	14,304	7,296	5,344	3,872	2,496	2,384	1,952	1,292	300,220	
26	39,120	98,752	90,752	31,856	14,080	6,960	5,296	3,808	2,480	2,400	1,872	1,224	298,600	
27	32,752	123,536	79,856	28,512	13,760	6,784	5,356	3,736	2,912	2,416	1,880	1,092	302,592	
28	29,216	114,784	86,144	26,400	13,216	6,768	5,344	3,808	3,016	2,424	2,212	1,164	294,496	
29	44,256	125,952	74,816	25,232	12,912	6,672	5,168	3,824	3,016	2,472	2,296	1,168	307,784	
30	65,152		68,880	23,152	12,608	6,656	4,992	3,920	2,924	2,736	2,288	1,292	194,600	
31	71,040		61,808		12,176		5,024	3,880		2,924		4,560	161,412	
PROMEDIO DIARIO (L/S)													256,090	

Ilustración 85: Registro de Descarga Diaria del Año 1976

REGISTRO DE DESCARGA DIARIA														
RIO CHICAMA			AÑO 1977							ESTACIÓN SALINAR				TOTAL
Día	Enero	Febrero	Marzo	Abril	Mayo	Junio	Julio	Agosto	Septiembre	Octubre	Noviembre	Diciembre		
1	5,008	60,624	87,000	149,000	43,700	13,200	8,000	5,952	4,224	4,352	3,360	3,360	387,780	
2	5,356	58,208	104,000	130,000	39,500	13,300	7,400	5,896	4,100	4,352	3,232	3,232	378,576	
3	5,712	79,760	74,000	108,000	36,400	13,100	7,520	5,710	4,192	4,128	3,072	3,072	344,666	
4	6,200	69,584	71,200	143,000	34,400	12,000	7,200	5,472	4,176	3,776	3,120	3,120	363,248	
5	10,612	79,616	63,360	107,700	34,700	11,500	7,400	5,472	4,168	3,776	2,928	2,928	334,160	
6	8,304	74,016	63,500	82,500	32,400	11,400	7,300	5,440	3,920	3,408	2,832	2,832	297,852	
7	6,960	64,608	54,800	74,600	29,700	10,300	7,080	5,440	3,800	3,408	3,504	3,504	267,704	
8	5,956	54,576	54,000	75,200	28,500	10,900	6,970	5,328	3,808	3,312	4,560	4,560	257,670	
9	9,580	47,888	44,200	61,700	26,600	11,300	6,880	5,480	3,808	3,312	4,896	4,896	230,540	
10	10,960	41,328	41,000	59,400	26,000	9,700	6,960	5,534	3,808	3,296	4,232	4,232	216,450	
11	13,760	39,840	38,700	57,600	26,300	9,600	6,890	5,480	3,808	3,808	3,920	3,920	213,626	
12	28,880	50,176	38,500	54,500	25,800	9,800	6,860	5,408	3,712	4,672	3,708	3,708	235,724	
13	23,168	67,488	54,100	51,000	24,600	9,700	6,900	5,352	3,600	4,784	3,296	3,296	257,284	
14	18,912	119,728	58,500	50,000	22,900	9,800	6,750	5,230	3,600	4,404	3,200	3,200	306,224	
15	14,048	90,172	52,600	45,600	21,800	9,800	6,720	5,184	3,616	4,448	3,208	3,208	260,404	
16	14,384	94,800	49,500	42,600	21,200	9,900	6,670	5,120	3,504	7,488	3,296	3,296	261,758	
17	15,664	130,500	41,600	39,500	20,200	9,800	6,380	5,008	3,504	6,704	3,404	3,404	285,668	
18	25,200	156,000	49,300	38,700	20,100	9,400	6,832	5,000	3,504	5,952	3,400	3,400	326,788	
19	27,072	222,000	46,000	39,800	20,200	9,300	7,360	4,560	3,312	5,124	4,124	4,124	392,976	
20	29,392	295,300	40,500	34,200	20,100	9,300	6,960	4,432	3,200	5,008	4,016	4,016	456,424	
21	35,376	302,400	36,600	32,600	19,400	9,100	6,832	4,416	3,200	4,336	4,232	4,232	462,724	
22	30,800	311,700	45,000	31,700	16,000	8,700	6,704	4,400	3,200	4,320	4,124	4,124	470,772	
23	20,048	363,000	165,700	70,400	16,600	8,400	6,704	4,336	3,200	3,920	3,404	3,404	669,116	
24	23,952	382,000	121,200	73,700	16,100	8,500	6,452	4,320	3,200	3,708	3,404	3,404	649,940	
25	31,440	304,900	130,000	62,000	15,500	8,400	6,448	4,288	3,200	3,808	3,208	3,208	576,400	
26	35,920	229,500	69,300	54,800	14,700	8,300	6,448	4,240	4,640	3,504	3,112	3,112	437,576	
27	31,104	228,700	74,100	54,600	14,200	8,200	6,200	4,128	5,120	3,404	3,112	3,112	435,980	
28	26,582	124,100	86,900	50,600	13,900	8,000	6,200	4,112	4,784	3,708	3,016	3,016	334,918	
29	24,912		103,400	54,600	13,800	8,400	6,200	4,016	4,672	3,308	3,604	3,604	230,516	
30	29,648		184,000	51,800	13,750	8,300	6,076	4,128	4,352	3,304	3,404	3,404	312,166	
31	35,424		150,000		13,300		6,072	4,240		3,300		3,404	215,740	
PROMEDIO DIARIO (L/S)													350,689	

Ilustración 86: Registro de Descarga Diaria del Año 1977

REGISTRO DE DESCARGA DIARIA														
RIO CHICAMA			AÑO 1978							ESTACIÓN SALINAR				TOTAL
Día	Enero	Febrero	Marzo	Abril	Mayo	Junio	Julio	Agosto	Septiembre	Octubre	Noviembre	Diciembre		
1	4,416	4,832	12,896	35,584	9,376	7,472	3,408	2,120	960	1,648	1,028	2,816	86,556	
2	4,176	4,400	12,240	20,624	9,872	6,832	3,408	2,048	964	1,424	1,092	2,192	69,272	
3	3,984	4,080	11,120	17,024	10,512	6,448	3,088	1,952	968	1,360	1,224	1,504	63,264	
4	4,000	3,536	10,480	14,864	9,664	6,176	3,136	2,032	896	1,216	1,292	1,440	58,732	
5	6,032	3,280	10,430	14,528	10,320	5,696	2,688	1,888	960	1,296	1,504	1,804	60,426	
6	5,792	3,168	9,456	13,440	10,000	5,472	2,720	1,872	1,088	1,424	1,576	1,432	57,440	
7	5,840	3,280	9,040	12,128	13,820	5,328	2,656	1,584	1,168	1,216	1,584	1,164	58,808	
8	5,664	3,168	7,648	9,760	17,888	5,128	2,640	1,648	1,152	1,216	1,092	1,092	58,096	
9	5,440	2,624	6,992	8,720	22,144	4,784	2,624	1,680	1,008	832	1,576	964	59,388	
10	5,200	3,536	5,984	8,608	21,240	4,432	2,560	1,726	896	896	1,432	968	57,478	
11	4,864	9,040	5,392	9,280	18,352	4,336	2,640	1,584	832	960	1,292	960	59,532	
12	4,496	9,280	4,608	8,160	14,272	4,128	2,608	1,600	832	960	1,164	832	52,940	
13	4,288	9,440	4,496	7,484	12,448	4,112	2,592	1,608	1,088	848	960	672	50,036	
14	3,664	7,648	4,392	6,576	12,448	4,130	2,592	1,648	1,216	832	1,292	672	47,110	
15	3,472	6,608	3,912	6,192	10,176	4,048	2,288	1,728	1,200	832	1,092	560	42,108	
16	3,264	6,352	3,504	6,448	10,176	4,032	2,288	1,744	1,216	768	1,028	672	41,492	
17	2,896	5,520	3,296	9,856	9,440	3,920	2,336	1,808	1,216	784	1,040	676	42,788	
18	2,790	4,944	3,108	10,336	8,880	3,920	2,736	1,424	1,584	768	904	620	42,014	
19	2,448	4,208	2,928	10,032	8,160	3,504	2,384	1,360	1,712	800	672	788	38,996	
20	2,112	4,064	3,712	14,480	7,488	3,792	2,304	1,360	1,712	784	608	862	43,278	
21	2,048	5,280	4,896	20,336	7,232	3,728	2,256	1,296	1,489	768	720	784	50,833	
22	2,204	6,608	4,774	15,232	6,832	3,760	2,288	1,360	1,584	772	784	720	46,918	
23	2,192	5,744	8,880	15,616	6,720	3,872	2,272	1,224	1,280	672	762	620	49,854	
24	2,200	9,008	17,424	14,144	6,448	3,760	2,208	1,216	1,280	680	680	512	59,560	
25	2,528	9,648	10,700	12,112	6,944	3,760	2,384	1,088	1,296	688	784	528	52,460	
26	2,456	10,480	9,424	10,960	8,032	3,664	2,208	1,088	1,424	672	620	896	51,924	
27	2,448	11,204	13,536	10,354	8,000	3,648	2,160	1,032	1,284	788	680	1,216	56,350	
28	2,440	14,256	9,984	10,160	8,160	3,570	2,144	904	1,296	904	788	2,560	57,166	
29	2,368		8,880	9,808	7,760	3,440	2,112	960	1,284	964	964	3,672	42,212	
30	2,664		10,704	9,680	8,000	3,169	2,080	1,028	1,712	896	2,688	4,336	46,957	
31	4,400		49,440		8,416		2,032	1,024		844		4,672	70,828	
PROMEDIO DIARIO (L/S)													54,026	

Ilustración 87: Registro de Descarga Diaria del Año 1978

REGISTRO DE DESCARGA DIARIA														
RIO CHICAMA			AÑO 1979							ESTACIÓN SALINAR				TOTAL
Día	Enero	Febrero	Marzo	Abril	Mayo	Junio	Julio	Agosto	Septiembre	Octubre	Noviembre	Diciembre		
1	4,224	2,912	12,448	36,200	9,690	6,600	3,100	2,100	1,800	1,290	960	600	81,924	
2	6,776	3,408	22,784	33,300	9,500	6,270	2,910	2,380	1,800	1,290	920	600	91,938	
3	5,472	5,248	27,040	28,624	9,240	6,110	2,910	2,120	1,800	1,220	920	600	91,304	
4	5,008	6,080	47,936	29,200	8,880	6,140	2,860	2,030	1,800	1,160	920	600	112,614	
5	4,096	12,352	58,752	33,300	8,730	5,630	2,830	2,030	1,630	1,160	920	520	131,950	
6	4,112	23,440	95,088	31,100	8,240	5,050	2,640	2,030	1,630	1,080	880	590	175,880	
7	3,600	18,080	121,616	29,300	7,880	5,390	2,560	1,870	1,570	1,160	880	595	194,501	
8	2,912	15,936	181,520	27,790	7,530	5,400	2,560	1,870	1,430	1,160	880	590	249,578	
9	2,648	20,544	159,536	26,960	6,830	5,050	2,560	1,870	1,430	1,160	880	500	229,968	
10	2,032	22,240	139,168	24,600	6,590	5,050	2,560	1,440	1,430	1,160	800	540	207,610	
11	1,720	20,576	106,768	21,600	6,040	4,970	2,500	1,440	1,430	1,080	800	540	169,464	
12	1,632	18,560	101,296	19,200	5,320	4,750	2,460	1,440	1,430	1,080	800	520	158,488	
13	1,504	21,296	109,936	19,200	5,240	4,750	2,280	1,500	1,360	960	800	520	169,346	
14	1,632	29,200	127,568	17,100	5,130	4,670	2,030	1,560	1,280	960	800	520	192,450	
15	1,808	24,896	80,300	15,400	5,024	4,300	2,030	1,500	1,280	890	800	840	139,068	
16	3,312	37,504	72,000	15,500	4,650	4,200	2,030	1,560	1,280	890	800	890	144,616	
17	3,920	37,344	70,000	15,800	4,680	4,200	2,000	1,440	1,280	890	800	840	143,194	
18	3,124	31,296	50,300	15,100	5,070	4,090	2,000	1,440	1,280	890	800	670	116,060	
19	2,656	26,144	59,700	16,100	4,860	3,900	2,000	1,440	1,360	780	860	670	120,470	
20	2,208	19,136	104,700	18,600	4,830	3,800	2,200	1,440	2,210	780	860	670	161,434	
21	2,216	15,200	160,500	18,200	4,780	3,800	2,200	1,440	2,040	780	920	670	212,746	
22	2,044	13,904	131,200	16,900	4,750	3,800	2,200	1,440	2,030	780	860	670	180,578	
23	2,464	12,256	102,800	15,400	5,820	3,500	2,120	1,440	2,030	780	860	670	150,140	
24	2,640	11,456	95,800	14,950	6,270	3,500	2,380	1,360	2,210	780	860	670	142,876	
25	2,560	10,672	112,500	13,100	6,030	3,600	2,380	1,440	2,200	780	860	670	156,792	
26	2,212	10,480	120,000	12,400	6,910	3,500	2,380	1,440	2,200	780	860	670	163,832	
27	1,888	9,024	95,300	11,880	6,910	3,500	2,380	1,290	2,030	780	860	670	136,512	
28	1,728	9,360	74,800	11,760	7,160	3,400	2,270	1,440	1,850	780	800	610	115,958	
29	1,504		43,800	10,800	7,280	3,100	2,270	1,440	1,570	780	750	610	73,904	
30	1,536		47,700	9,800	7,296	3,100	2,270	1,440	1,430	780	600	610	76,562	
31	3,200		40,300		6,650		2,270	1,440		960		610	55,430	
PROMEDIO DIARIO (L/S)													146,683	

Ilustración 88: Registro de Descarga Diaria del Año 1979

REGISTRO DE DESCARGA DIARIA														
RIO CHICAMA			AÑO 1980						ESTACIÓN SALINAR				TOTAL	
Día	Enero	Febrero	Marzo	Abril	Mayo	Junio	Julio	Agosto	Septiembre	Octubre	Noviembre	Diciembre		
1	610	1,020	770	5,600	960	720	680	460	220	80	2,380	11,280	24,780	
2	670	890	770	25,390	1,160	720	680	300	220	80	2,030	15,920	48,830	
3	670	890	670	15,420	1,020	720	680	300	264	80	2,920	14,300	37,934	
4	670	890	670	13,200	960	720	680	264	320	80	10,320	25,600	54,374	
5	670	780	1,160	13,200	1,160	720	680	264	368	64	7,740	26,880	53,686	
6	780	780	1,720	16,760	1,160	720	680	264	352	64	6,830	20,800	50,910	
7	780	780	1,570	13,880	1,160	720	680	264	320	80	7,080	19,160	46,474	
8	720	670	1,030	9,600	1,090	720	620	264	320	80	7,220	14,510	36,844	
9	720	670	960	8,860	1,090	720	620	380	288	80	4,410	10,320	29,118	
10	720	670	960	6,590	1,090	830	620	336	288	80	4,040	10,320	26,544	
11	610	670	960	5,580	1,090	830	620	336	288	80	3,400	15,760	30,224	
12	610	670	840	4,780	1,090	830	520	296	192	80	2,920	47,200	60,028	
13	780	620	840	3,912	1,090	830	420	296	208	760	2,470	46,000	58,226	
14	900	700	840	3,400	1,090	680	420	296	100	1,040	2,380	58,200	70,046	
15	720	700	840	3,400	1,090	720	460	296	100	1,190	2,040	45,000	56,556	
16	620	700	720	3,400	1,090	720	500	296	224	1,040	1,720	34,800	45,830	
17	620	700	720	3,200	1,090	680	500	296	140	1,040	1,630	31,024	41,640	
18	620	640	840	2,830	1,020	680	500	296	140	1,040	1,360	24,270	34,236	
19	620	640	720	2,290	1,020	720	500	220	160	1,640	960	16,160	25,650	
20	620	640	3,560	2,040	1,020	720	500	296	140	1,930	960	14,480	26,906	
21	620	1,510	3,240	1,720	1,020	720	500	296	80	3,040	1,090	13,340	27,176	
22	620	1,800	2,760	1,720	1,020	720	500	296	80	7,480	960	10,600	28,556	
23	620	1,630	5,020	1,500	1,000	680	500	296	140	5,000	960	9,580	26,926	
24	680	1,290	9,920	1,290	1,000	680	500	296	140	4,230	2,290	9,030	31,346	
25	560	1,290	8,090	1,290	1,000	680	460	296	160	4,440	3,020	8,300	29,586	
26	560	1,210	5,740	1,290	900	680	460	296	140	4,440	6,200	8,160	30,076	
27	620	1,090	4,400	1,020	900	680	460	296	140	4,010	6,830	7,480	27,926	
28	620	960	3,440	960	900	680	460	296	80	3,100	9,440	6,570	27,506	
29	2,040	770	2,880	960	830	680	460	264	80	2,380	10,320	6,200	27,864	
30	1,290		2,790	960	830	680	460	264	80	2,030	10,320	5,830	25,534	
31	1,180		2,530		830		460	264		2,470		5,470	13,204	
PROMEDIO DIARIO (L/S)														37,243

Ilustración 89: Registro de Descarga Diaria del Año 1980

REGISTRO DE DESCARGA DIARIA														
RIO CHICAMA			AÑO 1981							ESTACIÓN SALINAR				TOTAL
Día	Enero	Febrero	Marzo	Abril	Mayo	Junio	Julio	Agosto	Septiembre	Octubre	Noviembre	Diciembre		
1	4,890	11,600	80,000	30,330	13,710	6,700	4,120	2,640	1,880	900	6,110	2,120	165,000	
2	3,700	21,400	65,200	25,520	13,710	6,630	4,000	2,640	1,880	900	6,860	1,950	154,390	
3	3,400	39,990	54,000	24,510	13,710	6,190	3,900	2,380	1,880	900	6,600	1,720	159,180	
4	3,110	40,000	58,000	24,110	12,520	5,820	3,900	2,290	1,660	900	8,170	1,630	162,110	
5	3,400	100,000	48,000	24,110	11,870	5,340	3,900	2,210	1,660	900	6,860	1,630	209,880	
6	3,300	108,500	45,200	26,440	11,560	5,470	3,900	2,040	1,660	960	6,110	1,630	216,770	
7	2,920	140,000	88,000	27,290	9,260	5,470	3,900	1,800	1,660	960	5,400	2,460	289,120	
8	2,920	149,000	98,000	29,820	9,260	5,470	3,820	1,560	1,720	900	5,590	6,320	314,380	
9	8,870	123,000	290,000	28,640	9,160	5,340	3,820	1,560	1,720	830	9,320	5,360	487,620	
10	10,320	173,000	265,000	26,940	9,160	5,210	3,700	1,560	1,720	830	9,740	4,240	511,420	
11	17,870	140,000	220,000	25,370	8,160	5,210	3,700	1,640	1,650	830	19,710	3,820	447,960	
12	12,800	97,000	202,000	20,570	8,030	5,100	3,700	1,640	1,650	830	12,200	4,890	370,410	
13	13,640	169,000	274,000	23,530	8,080	4,860	3,700	1,640	1,650	900	9,030	4,120	514,150	
14	16,080	168,000	326,500	25,770	8,090	4,860	3,700	2,040	1,160	900	7,320	4,120	568,540	
15	15,040	196,800	168,980	25,770	8,280	4,860	3,600	2,040	1,160	900	6,430	4,780	438,640	
16	14,560	106,300	127,180	24,440	8,300	4,860	3,300	2,040	1,160	960	6,070	5,710	304,880	
17	13,930	80,000	125,500	24,650	8,300	4,860	3,300	2,040	1,160	1,020	5,280	6,910	276,950	
18	10,560	65,000	100,210	24,830	8,300	4,860	3,300	2,040	1,280	1,020	4,500	34,880	260,780	
19	8,880	72,000	99,540	25,200	8,410	4,780	3,300	2,040	1,280	1,360	3,910	18,380	249,080	
20	8,880	83,000	82,890	24,560	8,340	4,780	3,300	2,040	1,290	2,030	3,400	10,500	235,010	
21	8,880	176,000	75,550	25,080	8,240	4,780	3,200	1,880	1,160	2,030	3,300	11,130	321,230	
22	10,330	254,000	57,080	23,790	7,520	5,240	2,920	1,880	1,290	1,960	2,920	15,340	384,270	
23	8,880	289,000	51,690	21,850	7,320	4,800	2,920	1,880	1,290	2,370	2,830	15,820	410,650	
24	8,160	182,000	47,740	19,870	8,160	4,800	2,830	1,800	1,290	2,830	2,280	15,280	297,040	
25	7,480	165,000	40,300	19,850	7,610	4,780	2,830	1,800	1,160	2,860	2,030	13,580	269,280	
26	6,830	144,000	40,400	18,460	7,210	4,630	2,830	1,800	1,160	4,330	1,950	9,930	243,530	
27	6,200	117,000	37,370	17,740	7,260	4,630	2,640	1,720	1,160	5,260	1,880	9,930	212,790	
28	6,200	88,000	37,370	16,440	7,080	4,630	2,640	1,640	1,160	4,500	1,720	9,930	181,310	
29	6,830		37,440	15,770	7,080	4,630	2,640	1,570	1,160	4,810	1,720	9,000	92,650	
30	8,160		35,500	13,710	7,100	4,220	2,640	1,570	900	6,860	2,120	9,230	92,010	
31	10,320		33,210		7,180		2,640	1,720		5,870		9,230	70,170	
PROMEDIO DIARIO (L/S)													287,458	

Ilustración 90: Registro de Descarga Diaria del Año 1981

REGISTRO DE DESCARGA DIARIA													
RIO CHICAMA			AÑO 1982						ESTACIÓN SALINAR				TOTAL
Día	Enero	Febrero	Marzo	Abril	Mayo	Junio	Julio	Agosto	Septiembre	Octubre	Noviembre	Diciembre	
1	8,570	21,870	11,480	14,750	13,120	6,830	3,000	1,720	850	1,880	6,450	5,710	96,230
2	6,830	42,360	10,620	13,480	13,120	6,190	3,000	1,720	780	2,040	8,020	5,470	113,630
3	6,190	53,790	9,470	11,210	12,380	5,710	3,000	1,640	780	2,040	11,500	4,450	122,160
4	5,950	40,000	9,470	11,050	11,710	5,230	3,000	1,500	780	2,470	9,440	4,570	105,170
5	5,470	37,400	9,000	13,920	10,650	5,000	2,750	1,500	780	3,400	6,060	4,570	100,500
6	5,000	33,600	9,640	18,320	9,790	5,000	2,750	1,500	750	3,400	6,060	5,520	101,330
7	4,440	47,040	7,610	31,060	9,150	4,560	2,750	1,500	750	3,100	6,060	9,580	127,600
8	3,910	48,680	7,730	34,380	8,860	4,440	2,620	1,500	750	3,100	6,060	22,620	144,650
9	3,300	45,920	7,730	29,420	8,860	4,440	2,620	1,500	750	2,480	6,060	66,220	179,300
10	2,830	46,700	7,020	41,820	8,190	4,220	2,520	1,500	700	2,480	4,120	59,530	181,630
11	2,730	40,560	6,300	84,620	7,980	4,220	2,520	1,360	700	1,990	4,120	36,700	193,800
12	2,290	32,816	5,560	70,350	7,790	4,020	2,200	1,360	700	1,990	3,200	29,370	161,646
13	3,110	27,840	6,080	57,790	8,080	4,020	2,320	1,500	700	2,300	2,920	25,120	141,780
14	3,700	22,400	6,080	47,950	7,960	3,960	2,320	1,360	700	3,020	3,200	29,000	131,650
15	4,440	21,370	6,080	37,480	7,660	3,960	2,320	1,360	700	2,650	3,200	25,770	116,990
16	3,800	19,130	8,595	32,890	7,660	3,960	2,200	1,360	600	2,460	9,580	21,390	113,625
17	3,300	21,870	11,535	28,650	7,960	3,960	2,200	1,360	600	2,830	8,800	18,970	112,035
18	3,010	20,090	13,835	24,540	9,100	3,560	2,200	1,600	600	3,020	8,880	14,840	105,275
19	3,700	18,280	20,320	21,660	8,800	3,470	2,200	1,240	600	3,200	10,000	14,840	108,310
20	5,590	16,528	23,690	19,260	8,350	3,470	2,200	1,240	600	3,200	10,000	11,470	105,598
21	4,890	15,390	20,080	16,640	8,320	3,470	2,200	1,180	600	3,200	11,000	12,490	99,460
22	4,780	14,570	18,730	14,360	8,170	3,340	2,200	1,180	550	3,020	11,000	29,500	111,400
23	6,450	13,630	16,430	13,920	8,170	3,340	2,200	1,180	550	2,800	16,010	30,830	115,510
24	8,870	10,040	17,430	13,440	8,320	3,420	1,800	1,180	550	2,800	13,000	27,900	108,750
25	9,580	10,200	22,655	13,440	8,870	3,420	1,800	1,180	1,000	9,600	10,620	26,620	118,985
26	8,160	9,520	25,690	13,440	8,570	3,420	1,720	1,000	1,000	9,600	9,580	25,530	117,230
27	9,600	8,490	22,640	13,450	8,570	3,420	1,720	1,000	2,200	7,480	6,200	21,000	105,770
28	14,750	7,400	18,800	13,950	7,880	3,420	1,720	1,000	2,200	8,620	8,000	19,880	107,620
29	21,600		16,120	13,840	8,000	2,890	1,720	1,000	2,040	9,440	7,620	19,880	104,150
30	24,830		15,290	13,470	8,000	2,890	1,720	1,000	2,040	11,500	7,620	15,560	103,920
31	24,510		14,840		7,210		1,720	900		6,830		14,270	70,280
PROMEDIO DIARIO (L/S)													120,193

Ilustración 91: Registro de Descarga Diaria del Año 1982

REGISTRO DE DESCARGA DIARIA													
RIO CHICAMA			AÑO 1983						ESTACIÓN SALINAR				TOTAL
Día	Enero	Febrero	Marzo	Abril	Mayo	Junio	Julio	Agosto	Septiembre	Octubre	Noviembre	Diciembre	
1	13,450	41,370	44,300	600,000	400,000	39,000	14,000	9,000	6,800	5,290	4,480	6,680	1,184,370
2	12,450	38,380	41,260	450,000	300,000	40,000	15,600	8,400	6,800	5,290	4,480	6,170	928,830
3	11,630	33,180	72,400	350,000	280,000	34,500	15,600	8,400	6,800	5,290	4,200	5,760	827,760
4	10,580	33,440	61,150	200,000	220,000	36,000	15,000	8,400	6,800	6,030	4,200	5,760	607,360
5	13,930	31,440	58,830	250,000	260,000	36,000	15,300	8,400	6,940	5,530	4,200	8,200	698,770
6	19,070	31,440	92,590	280,000	220,000	35,000	14,200	8,400	6,940	5,600	4,200	9,800	727,240
7	58,830	42,000	89,120	250,000	180,000	34,000	12,800	8,400	7,100	5,600	3,840	9,800	701,490
8	88,200	60,800	90,900	470,000	160,000	30,000	12,800	8,400	7,100	5,710	3,840	10,600	948,350
9	51,950	59,960	75,500	320,000	100,000	29,800	12,800	8,400	7,100	5,710	3,840	10,450	685,510
10	39,820	44,480	102,500	370,000	70,000	29,800	12,800	7,800	7,100	5,310	3,600	10,060	703,270
11	41,800	28,810	112,810	340,000	65,000	72,000	12,000	7,800	7,100	5,470	3,600	8,380	704,770
12	35,280	26,220	197,300	380,000	60,000	50,000	12,000	7,800	8,270	5,470	3,520	7,650	793,510
13	32,000	26,200	261,320	360,000	62,000	37,000	12,000	7,800	9,120	6,380	3,520	6,940	824,280
14	37,050	45,500	177,180	400,000	55,520	32,000	11,800	7,800	9,120	9,120	3,520	6,490	795,100
15	54,990	40,510	121,240	340,000	55,000	25,500	11,800	7,200	9,120	10,040	3,520	5,890	684,810
16	56,800	33,740	360,400	350,000	78,720	27,000	10,600	7,200	8,200	10,040	3,520	6,640	952,860
17	88,650	33,100	210,300	320,000	54,000	27,000	10,600	7,200	8,200	11,800	3,520	6,200	780,570
18	112,350	43,950	161,800	220,000	360,000	26,000	10,600	7,200	8,200	11,720	3,520	6,200	971,540
19	96,220	81,800	285,160	190,000	185,000	26,000	11,000	7,200	7,120	11,640	3,520	5,530	910,190
20	109,480	79,800	800,000	160,000	150,000	26,000	10,900	7,200	7,000	11,000	3,520	8,460	1,373,360
21	90,800	48,270	400,000	150,000	170,000	25,600	10,300	7,200	7,000	10,090	3,520	17,700	940,480
22	90,600	39,520	304,000	220,000	140,000	22,300	10,300	7,200	6,670	9,260	3,520	19,860	873,230
23	90,500	64,890	160,000	260,000	115,000	22,300	8,970	7,200	6,270	9,260	3,220	18,190	765,800
24	63,800	71,160	133,000	200,000	80,000	20,400	8,970	7,200	6,040	7,690	3,220	30,640	632,120
25	52,830	79,800	117,500	240,000	68,000	19,000	8,970	7,200	6,040	7,690	3,260	38,320	648,610
26	55,690	63,320	101,690	250,000	56,000	19,000	8,970	7,200	5,740	7,360	3,580	28,690	607,240
27	79,200	63,160	113,640	220,000	56,000	18,000	9,000	7,200	5,180	6,140	3,580	19,650	600,750
28	106,120	49,200	107,720	350,000	45,000	17,000	9,000	7,200	5,290	5,760	6,190	20,100	728,580
29	95,900		137,640	270,000	40,000	17,000	9,000	7,200	5,560	5,280	6,190	19,260	613,030
30	95,500		545,000	250,000	38,000	16,700	9,000	7,200	5,610	5,280	9,060	16,670	998,020
31	55,980		900,000		40,400		9,000	7,200		4,480		16,670	1,033,730
PROMEDIO DIARIO (L/S)													814,372

Ilustración 92: Registro de Descarga Diaria del Año 1983

REGISTRO DE DESCARGA DIARIA														
RIO CHICAMA			AÑO 1984							ESTACIÓN EL TAMBO				TOTAL
Día	Enero	Febrero	Marzo	Abril	Mayo	Junio	Julio	Agosto	Septiembre	Octubre	Noviembre	Diciembre		
1	13,320	13,550	280,000	55,000	58,000	26,000	14,000	8,000	4,800	4,500	7,300	34,700	519,170	
2	13,320	14,750	350,000	60,000	80,000	26,000	13,000	7,500	4,800	4,600	7,300	44,500	625,770	
3	13,320	18,080	510,000	59,000	67,000	26,000	13,000	7,000	4,800	4,500	6,800	33,080	762,580	
4	11,280	53,420	350,000	55,000	64,000	26,000	13,000	6,800	4,700	4,200	6,820	35,400	630,620	
5	10,380	56,030	250,000	53,000	62,000	26,000	13,000	6,800	4,700	4,000	6,000	30,100	522,010	
6	9,840	120,760	190,000	52,000	63,000	26,000	13,000	6,500	4,700	3,600	5,300	27,000	521,700	
7	8,940	121,420	180,000	48,000	59,000	26,000	12,500	6,000	4,700	3,600	4,600	23,300	498,060	
8	8,940	187,000	160,000	49,000	57,000	25,000	12,500	6,000	4,700	3,600	3,900	23,300	540,940	
9	7,560	170,000	175,000	56,000	57,000	25,000	12,500	6,000	4,700	3,600	3,600	21,000	541,960	
10	7,560	175,000	235,000	55,000	65,000	25,000	13,000	5,700	4,700	3,600	3,600	19,200	612,360	
11	6,640	138,000	135,000	56,000	67,000	24,000	13,000	5,700	4,700	3,900	3,600	15,000	472,540	
12	6,440	120,000	120,000	53,000	66,000	23,000	12,500	5,700	5,240	3,900	2,960	12,700	431,440	
13	5,850	112,000	105,000	53,000	66,000	21,000	12,500	5,700	5,240	3,900	2,960	11,700	404,850	
14	5,850	166,000	110,000	53,000	63,000	21,000	12,000	5,700	4,800	3,900	2,960	10,800	459,010	
15	5,850	170,000	115,000	53,000	59,000	20,000	12,000	5,700	4,800	3,700	2,960	10,800	462,810	
16	4,640	162,000	105,000	51,000	51,000	20,000	12,000	5,700	4,800	4,160	2,960	10,800	434,060	
17	6,060	190,000	80,000	49,000	48,000	20,000	11,500	5,700	4,600	4,700	2,960	9,200	431,720	
18	6,060	280,000	70,000	57,000	48,000	19,000	11,500	5,700	4,360	13,200	2,960	8,200	525,980	
19	6,290	318,000	56,000	52,000	45,000	19,000	11,000	5,700	4,360	11,400	2,960	8,200	539,910	
20	12,650	250,000	53,000	52,000	45,000	19,000	10,000	5,300	4,480	11,900	2,960	7,700	473,990	
21	10,280	334,000	63,000	49,000	40,000	19,000	10,000	5,300	4,480	14,500	3,500	7,700	560,760	
22	21,170	300,000	58,000	49,000	37,000	18,000	10,000	5,300	4,600	12,600	3,500	7,440	526,610	
23	17,040	250,000	56,000	45,000	37,000	17,000	9,500	5,300	4,600	14,600	3,500	7,440	466,980	
24	14,430	210,000	57,000	46,000	38,000	17,000	9,500	4,900	5,500	14,600	4,000	8,100	429,030	
25	11,560	208,000	64,800	63,000	38,000	17,000	9,500	4,900	5,800	14,600	4,000	8,100	449,260	
26	12,830	250,000	60,000	55,000	37,000	16,000	9,500	4,900	5,240	12,640	4,000	7,870	474,980	
27	23,100	290,000	56,000	50,000	37,000	15,000	9,000	4,900	4,800	12,640	12,240	7,870	522,550	
28	20,000	280,000	63,000	58,000	37,000	15,000	9,000	4,900	4,540	12,640	13,600	7,080	524,760	
29	17,800	260,000	60,000	58,000	34,000	15,000	9,000	4,900	4,400	13,200	26,800	6,490	509,590	
30	16,490		61,000	56,000	30,000	14,000	8,000	4,900	4,400	9,900	20,500	6,490	231,680	
31	15,313		56,000		27,000		8,000	4,700		8,600		7,390	127,003	
PROMEDIO DIARIO (L/S)													491,441	

Ilustración 93: Registro de Descarga Diaria del Año 1984

REGISTRO DE DESCARGA DIARIA														
RIO CHICAMA			AÑO 1985							ESTACIÓN EL TAMBO				TOTAL
Día	Enero	Febrero	Marzo	Abril	Mayo	Junio	Julio	Agosto	Septiembre	Octubre	Noviembre	Diciembre		
1	7,390	5,360	17,440	11,870	10,520	4,860	2,570	1,790	1,790	2,700	1,400	920	68,610	
2	8,800	5,360	16,860	13,690	9,630	4,860	2,570	1,790	1,790	2,700	1,400	920	70,370	
3	9,300	5,360	16,860	15,600	9,630	4,170	2,510	1,790	1,790	2,700	1,400	920	72,030	
4	8,750	5,360	13,700	24,400	9,630	4,600	2,510	1,790	1,790	2,700	1,160	920	77,310	
5	7,930	5,360	14,160	24,400	9,630	4,480	2,830	1,790	1,790	2,700	1,160	920	77,150	
6	7,930	5,360	14,160	20,800	9,040	4,480	2,830	1,900	1,790	2,700	1,160	920	73,070	
7	7,930	5,070	20,640	20,800	9,040	4,480	2,830	1,900	1,790	2,700	1,100	820	79,100	
8	8,590	5,070	21,360	16,950	8,280	4,480	2,830	1,900	1,790	2,700	1,100	820	75,870	
9	8,300	4,710	21,360	16,700	7,760	4,480	2,830	1,900	1,790	2,460	1,100	750	74,140	
10	8,020	4,710	21,360	16,100	7,300	4,700	2,940	1,900	1,790	2,460	1,100	750	73,130	
11	7,740	6,400	39,850	15,900	6,590	4,700	2,940	1,900	1,790	2,460	1,100	750	92,120	
12	7,600	8,690	41,200	16,300	6,590	4,560	2,990	1,900	1,790	2,460	1,100	750	95,930	
13	7,600	8,240	65,000	17,300	9,020	4,480	2,990	1,900	1,790	2,460	1,100	750	122,630	
14	7,600	11,550	71,000	17,300	8,250	4,480	2,990	1,900	1,790	2,130	1,040	750	130,780	
15	8,200	22,670	60,000	16,520	7,450	4,330	2,830	1,940	1,790	2,130	1,040	750	129,650	
16	8,720	22,940	43,700	16,000	7,450	4,330	2,830	1,940	1,400	2,130	1,040	2,320	114,800	
17	9,230	22,940	34,100	15,150	7,450	4,330	2,830	1,940	1,400	2,130	1,040	2,320	104,860	
18	9,300	18,350	30,800	14,600	7,450	4,110	2,830	1,940	1,400	1,730	980	2,451	95,941	
19	9,000	17,100	26,100	13,920	7,450	3,900	2,830	1,940	1,400	1,730	980	2,820	89,170	
20	9,000	16,670	22,500	13,340	7,450	3,630	2,830	1,940	1,400	1,730	900	3,520	84,910	
21	8,400	17,550	18,700	13,340	7,450	3,630	2,830	1,940	1,400	1,640	900	5,180	82,960	
22	8,190	17,600	18,000	14,830	7,450	3,420	2,480	1,940	1,400	1,640	980	7,320	85,250	
23	7,260	16,080	17,120	14,120	7,100	3,420	2,030	1,940	2,830	1,640	980	6,120	80,640	
24	7,050	16,080	17,120	13,960	6,440	3,290	2,240	1,940	3,280	1,640	980	5,000	79,020	
25	6,600	24,460	14,160	13,400	6,440	3,290	2,240	1,940	3,280	1,560	980	5,000	83,350	
26	6,250	23,240	13,450	12,040	6,440	2,840	2,240	1,940	2,940	1,560	980	3,820	77,740	
27	6,250	23,240	12,480	12,040	6,110	2,840	2,060	1,940	4,140	1,560	980	3,820	77,460	
28	5,880	17,950	11,870	12,040	6,110	2,650	2,060	1,940	3,930	1,400	980	5,600	72,410	
29	5,880		11,870	11,150	5,550	2,650	2,060	1,940	3,930	1,400	920	5,600	52,950	
30	5,360		11,870	10,520	5,280	2,650	2,060	1,940	2,910	1,400	920	4,510	49,420	
31	5,360		11,870		5,280		2,060	1,940		1,400		4,010	31,920	
PROMEDIO DIARIO (L/S)													83,055	

Ilustración 94: Registro de Descarga Diaria del Año 1985

REGISTRO DE DESCARGA DIARIA													
RIO CHICAMA			AÑO 1986						ESTACIÓN EL TAMBO				TOTAL
Día	Enero	Febrero	Marzo	Abril	Mayo	Junio	Julio	Agosto	Septiembre	Octubre	Noviembre	Diciembre	
1	4,010	41,500	22,400	43,020	34,460	10,320	4,030	2,750	1,920	1,000	800	1,600	167,810
2	2,780	27,070	19,130	54,000	35,340	9,870	3,900	2,750	2,000	1,060	800	1,536	160,236
3	2,780	27,070	18,000	36,780	33,900	9,710	3,870	2,750	2,000	1,080	990	1,312	140,242
4	2,360	25,740	15,980	36,780	33,900	9,040	3,610	2,650	2,000	780	1,260	1,208	135,308
5	2,360	22,350	14,300	50,270	30,500	8,810	3,610	2,650	2,000	780	2,216	1,160	141,006
6	3,080	18,300	12,980	64,400	28,350	8,040	3,610	2,550	1,970	800	4,000	964	149,024
7	5,100	17,420	13,160	94,510	24,100	7,580	3,360	2,400	1,970	780	4,900	712	175,992
8	8,620	14,960	15,000	86,430	23,760	7,580	3,360	2,400	1,830	750	4,900	648	170,238
9	8,620	14,200	14,200	99,000	23,050	6,860	3,360	2,320	1,800	860	5,520	544	180,334
10	8,270	12,590	12,700	88,800	21,290	6,730	3,360	2,320	1,730	750	7,640	488	166,668
11	7,320	11,980	11,500	73,180	21,290	6,320	3,310	2,250	1,730	1,016	5,910	488	146,294
12	7,320	10,120	10,700	62,960	18,940	5,970	3,260	2,150	1,560	1,016	4,864	472	129,332
13	7,320	10,120	10,250	50,400	18,350	5,770	3,260	2,100	1,380	885	4,296	520	114,651
14	11,320	12,090	9,900	46,000	16,760	5,690	3,020	2,100	1,380	885	3,544	4,936	117,625
15	12,440	20,500	9,210	41,230	15,280	5,690	2,930	2,100	1,220	840	2,936	5,360	119,736
16	13,320	38,800	10,270	33,800	14,440	5,260	2,930	2,100	1,310	840	2,484	6,264	131,818
17	19,888	32,670	11,550	53,600	13,900	4,970	2,930	2,100	1,310	840	2,280	4,584	150,622
18	12,320	26,500	11,550	53,600	13,900	4,970	3,100	2,000	1,230	840	1,880	4,083	135,973
19	15,320	21,240	11,150	70,640	11,790	4,970	3,100	2,000	1,180	840	1,880	3,672	147,782
20	12,000	19,000	11,690	70,640	11,350	4,860	3,100	1,950	1,070	760	1,640	3,432	141,492
21	11,800	17,160	11,420	70,220	11,200	4,860	3,100	1,950	1,070	860	1,904	3,008	138,552
22	13,390	15,000	11,420	58,400	10,840	4,860	3,100	2,270	912	860	3,616	2,736	127,404
23	23,340	15,000	16,120	56,700	9,960	4,840	3,100	2,270	912	860	4,784	2,804	140,690
24	25,120	15,000	23,210	51,340	9,900	4,800	3,100	2,270	912	800	4,784	4,504	145,740
25	34,160	15,600	20,190	43,470	9,900	4,680	3,100	2,200	1,000	800	4,016	4,904	144,020
26	34,160	20,500	20,190	40,830	10,330	4,590	3,000	2,100	1,000	800	3,328	5,016	145,844
27	52,890	30,400	35,500	40,830	11,290	4,540	3,000	2,000	1,000	800	2,536	5,608	190,394
28	71,790	24,570	47,280	37,280	11,480	4,360	3,000	1,950	1,000	800	2,216	15,960	221,686
29	163,700		45,980	37,280	11,130	4,360	3,000	1,920	1,000	800	2,040	20,504	291,714
30	80,000		37,820	34,840	10,880	4,270	2,950	2,160	1,000	800	1,816	22,016	198,552
31	50,140		45,400		10,680		2,950	2,160		800		21,592	133,722
PROMEDIO DIARIO (L/S)													154,855

Ilustración 95: Registro de Descarga Diaria del Año 1986

REGISTRO DE DESCARGA DIARIA														
RIO CHICAMA			AÑO 1987							ESTACIÓN EL TAMBO				TOTAL
Día	Enero	Febrero	Marzo	Abril	Mayo	Junio	Julio	Agosto	Septiembre	Octubre	Noviembre	Diciembre		
1	20,728	50,496	32,960	21,656	28,176	7,192	3,728	2,688	1,988	1,968	1,220	2,260	175,060	
2	20,636	44,864	34,784	19,192	46,288	7,000	3,704	2,688	1,988	1,824	1,124	2,260	186,352	
3	21,626	39,776	38,816	18,280	32,224	6,500	3,704	2,688	1,796	1,744	1,044	2,136	170,334	
4	20,040	41,920	36,880	18,344	31,488	5,872	3,704	3,880	1,796	1,744	896	2,352	168,916	
5	44,326	44,656	33,648	21,576	31,760	5,468	3,704	4,340	1,796	2,276	896	2,204	196,650	
6	48,216	87,259	37,856	21,936	29,072	5,424	3,704	4,340	1,796	2,992	896	2,204	245,695	
7	52,312	111,744	40,608	20,936	28,304	5,424	3,704	3,576	1,876	2,864	896	1,956	274,200	
8	41,440	111,744	72,608	17,832	25,696	5,272	3,704	3,368	2,092	2,336	896	1,956	288,944	
9	29,828	87,392	53,132	16,744	25,632	5,272	3,704	3,368	2,156	2,068	896	1,764	231,956	
10	24,976	74,464	71,776	21,488	25,632	5,272	3,704	3,232	2,156	2,068	1,560	1,764	238,092	
11	24,976	67,296	42,944	18,976	22,752	5,272	3,632	3,232	2,156	2,068	1,560	1,764	196,628	
12	29,352	75,856	38,224	18,568	20,768	5,272	3,632	3,084	2,112	1,832	1,856	1,656	202,212	
13	31,586	72,816	36,400	19,424	19,600	5,160	3,632	2,832	2,112	1,656	1,872	1,656	198,746	
14	31,586	72,112	36,432	18,600	17,504	5,160	3,568	2,720	2,020	1,720	1,752	1,748	194,922	
15	28,246	153,776	34,400	18,784	17,208	5,104	3,568	2,616	1,876	1,532	1,752	1,748	270,610	
16	34,136	98,592	35,296	18,184	15,504	4,872	3,432	2,616	1,876	1,620	1,524	1,796	219,448	
17	30,276	71,424	32,240	29,896	15,504	4,872	3,256	2,256	1,876	1,692	2,944	1,968	198,204	
18	25,336	60,848	31,152	32,824	14,392	4,872	3,120	2,104	1,876	1,692	3,352	2,156	183,724	
19	22,796	61,472	28,064	23,624	14,136	4,872	3,120	2,032	1,876	1,556	5,196	2,156	170,900	
20	41,336	59,952	24,416	23,624	13,968	4,872	2,968	1,952	1,876	1,452	5,948	2,156	184,520	
21	41,336	52,896	22,560	23,024	13,424	4,872	2,968	1,952	1,784	1,472	7,268	2,156	175,712	
22	90,384	49,472	22,448	20,488	12,408	4,520	3,016	1,952	1,612	1,472	5,520	2,156	215,448	
23	87,024	49,472	21,152	59,040	11,512	4,520	3,016	1,952	1,560	1,404	5,308	2,048	248,008	
24	108,320	48,208	19,728	40,160	11,096	4,520	3,016	1,952	1,380	1,348	4,420	2,048	246,196	
25	123,424	43,136	23,538	34,272	10,016	4,520	2,880	1,908	1,320	1,348	3,920	2,048	252,330	
26	82,384	39,232	21,816	35,200	9,736	4,520	2,880	1,976	2,236	1,348	3,920	1,968	207,216	
27	77,232	33,424	34,160	26,728	9,368	4,424	2,880	2,096	2,236	1,308	3,588	1,968	199,412	
28	69,328	32,320	35,888	23,808	9,368	4,424	2,880	2,096	2,120	1,280	2,712	3,400	189,624	
29	71,024		29,184	22,832	8,412	4,168	2,880	2,096	2,120	1,280	2,712	3,104	149,812	
30	60,160		25,856	22,080	7,736	4,024	2,688	2,096	2,120	1,280	2,260	2,784	133,084	
31	58,384		23,456		7,736		2,688	1,880		1,220		2,512	97,876	
PROMEDIO DIARIO (L/S)													203,575	

Ilustración 96: Registro de Descarga Diaria del Año 1987

REGISTRO DE DESCARGA DIARIA													
RIO CHICAMA			AÑO 1988						ESTACIÓN EL TAMBO				TOTAL
Día	Enero	Febrero	Marzo	Abril	Mayo	Junio	Julio	Agosto	Septiembre	Octubre	Noviembre	Diciembre	
1	1,920	31,254	43,968	13,440	35,024	8,160	3,056	1,984	1,112	1,256	2,992	4,708	148,874
2	1,920	28,208	41,008	13,116	30,896	8,096	3,056	1,984	1,112	1,256	2,820	4,088	137,560
3	1,920	35,536	38,480	15,184	28,336	8,096	2,960	1,984	1,112	1,204	2,628	4,088	141,528
4	1,920	33,408	39,936	25,776	25,488	8,640	2,960	1,984	1,112	1,132	2,976	3,392	148,724
5	1,812	32,096	41,408	22,456	23,440	8,528	2,960	1,984	1,112	1,112	3,112	2,720	142,740
6	1,728	26,976	34,432	20,944	22,656	8,320	2,960	1,856	1,112	1,068	3,112	2,278	127,442
7	1,664	24,016	32,752	36,608	21,456	7,808	3,016	1,856	1,112	1,068	2,976	2,092	136,424
8	1,412	21,176	31,200	28,800	20,144	7,286	3,016	1,720	1,112	1,068	2,976	2,092	122,002
9	1,228	20,272	34,720	25,536	19,296	6,864	3,016	1,688	1,112	1,068	2,668	1,864	119,332
10	1,228	20,176	45,808	21,888	18,736	6,336	3,016	1,632	1,112	1,068	2,668	1,552	125,220
11	1,112	22,360	45,440	22,736	17,072	5,760	3,016	1,632	1,120	1,068	2,668	1,552	125,536
12	1,324	26,544	38,368	46,176	16,224	5,248	3,016	1,632	1,112	1,068	2,668	1,232	144,612
13	1,784	35,120	34,912	66,848	15,200	5,008	2,704	1,596	1,112	1,320	2,668	1,088	169,360
14	2,136	45,440	29,552	74,400	14,912	5,088	2,960	1,596	1,112	3,264	2,136	1,088	183,684
15	2,136	41,984	26,208	77,856	14,912	5,088	2,752	1,540	1,112	3,136	2,136	1,088	179,948
16	2,448	36,864	24,192	71,504	14,368	5,088	2,752	1,496	1,112	3,136	3,052	1,028	167,040
17	9,120	33,984	21,456	53,856	13,760	33,984	4,944	2,752	1,496	1,112	2,320	7,376	153,328
18	24,304	37,920	20,528	46,400	13,376	4,704	2,576	1,436	1,112	2,156	6,944	1,152	162,608
19	26,304	35,840	20,944	40,464	12,752	4,560	2,576	1,436	1,112	2,284	9,408	1,088	158,768
20	21,504	31,168	19,904	34,576	12,916	4,288	2,576	1,436	1,120	2,152	7,888	1,360	140,888
21	19,619	28,352	17,040	31,952	11,168	4,108	2,532	1,436	1,112	2,152	7,376	1,432	128,279
22	22,800	25,600	15,928	29,136	10,864	4,048	2,532	1,328	1,312	2,152	7,040	3,664	126,404
23	27,040	23,728	15,952	30,608	10,592	4,000	2,488	1,236	1,420	2,152	5,600	4,352	129,168
24	26,384	31,392	16,400	28,560	10,672	3,936	2,488	1,168	1,420	2,152	5,104	3,472	133,148
25	27,184	38,240	15,600	27,536	10,544	3,728	2,204	1,168	1,420	2,208	4,400	3,472	137,704
26	47,696	39,056	14,288	29,888	9,744	3,552	2,204	1,168	1,336	2,312	3,568	4,400	159,212
27	49,520	37,696	14,040	33,008	9,408	3,440	2,156	1,168	1,284	2,280	3,568	6,336	163,904
28	47,648	42,512	13,400	37,744	9,008	3,344	2,156	1,168	1,256	1,984	3,080	6,208	169,508
29	46,912	43,312	13,144	37,168	8,768	3,344	2,156	1,112	1,256	1,984	3,260	5,248	167,664
30	38,016		14,160	40,832	8,576	3,264	2,032	1,112	1,256	1,984	4,528	4,724	120,484
31	34,992		13,504		8,512		2,032	1,112		2,992		4,724	67,868
PROMEDIO DIARIO (L/S)													143,192

Ilustración 97: Registro de Descarga Diaria del Año 1988

REGISTRO DE DESCARGA DIARIA														
RIO CHICAMA			AÑO 1989							ESTACIÓN EL TAMBO				TOTAL
Día	Enero	Febrero	Marzo	Abril	Mayo	Junio	Julio	Agosto	Septiembre	Octubre	Noviembre	Diciembre		
1	4,724	27,264	112,420	76,400	46,864	9,952	6,976	4,024	2,380	2,960	12,820	1,568	308,352	
2	4,464	57,248	96,672	76,400	43,616	9,392	6,979	4,024	2,312	2,760	12,820	1,568	318,255	
3	6,224	97,248	75,216	115,408	40,640	8,720	6,979	3,832	2,312	2,760	13,376	1,568	374,283	
4	9,168	89,872	137,040	112,576	40,384	8,720	6,480	3,832	2,216	2,760	11,712	1,680	426,440	
5	20,448	141,168	105,792	116,080	38,112	9,176	6,480	3,712	2,216	2,760	8,868	1,680	456,492	
6	19,468	136,048	90,832	112,464	34,528	9,176	6,368	3,712	2,265	2,760	8,868	1,600	428,089	
7	25,552	125,072	129,328	83,348	32,752	8,904	6,368	3,372	2,265	2,760	8,868	1,600	430,189	
8	25,468	97,312	133,456	81,632	34,816	8,616	6,368	3,372	2,265	2,760	6,728	1,600	404,393	
9	18,688	102,064	93,600	78,320	31,880	8,388	6,368	3,372	2,265	2,760	6,412	1,600	355,717	
10	14,576	85,088	82,208	77,536	29,200	7,832	5,676	3,372	2,265	2,760	4,984	1,424	316,921	
11	13,072	74,064	85,088	67,664	27,376	7,832	5,616	3,372	2,265	2,760	4,536	1,384	295,029	
12	12,976	83,120	73,744	67,664	24,904	7,800	5,560	3,372	2,265	3,352	3,848	1,448	290,053	
13	15,360	99,248	69,984	69,248	23,008	7,800	5,416	3,372	2,304	3,956	3,848	1,448	304,992	
14	14,944	95,808	64,832	63,192	21,992	8,144	5,416	3,160	2,304	7,408	3,572	1,352	292,124	
15	15,952	87,808	72,688	64,448	20,096	8,352	5,312	3,160	2,304	13,798	3,296	1,688	298,902	
16	18,736	81,296	66,752	98,288	19,612	8,352	5,312	3,160	2,304	10,740	2,992	1,640	319,184	
17	18,080	76,720	83,808	82,288	19,124	8,268	4,984	3,064	2,304	11,972	2,720	1,480	314,812	
18	16,208	67,856	70,576	78,944	18,520	8,268	4,984	2,928	2,304	13,504	2,188	1,480	287,760	
19	21,200	67,856	73,876	67,744	18,468	7,628	4,890	2,920	2,304	10,052	1,932	1,280	280,150	
20	22,608	67,584	80,000	72,816	16,984	7,628	4,840	2,928	2,304	8,172	1,932	1,128	288,924	
21	19,184	88,624	75,696	80,416	16,456	7,676	4,656	2,856	2,304	7,488	1,744	1,128	308,228	
22	19,184	69,792	91,408	72,560	15,468	7,536	4,460	2,856	2,304	6,844	1,744	1,096	295,252	
23	20,672	137,152	100,192	67,088	14,792	7,312	4,184	2,784	2,304	6,844	1,744	1,096	366,164	
24	28,096	161,770	91,744	62,512	12,804	6,992	3,980	2,836	2,304	8,216	1,596	1,096	383,946	
25	27,968	161,770	103,536	59,552	12,656	6,992	4,008	2,656	2,304	7,008	1,576	1,096	391,122	
26	27,584	178,208	103,536	59,248	12,088	6,920	4,008	2,656	2,180	8,868	1,480	1,096	407,872	
27	31,488	136,992	87,328	55,440	11,408	6,976	4,008	2,656	2,180	10,472	1,480	1,096	351,524	
28	32,128	103,824	70,576	55,712	11,408	6,976	4,008	2,428	2,180	18,124	1,480	1,096	309,940	
29	29,392		68,976	50,336	10,780	6,976	4,008	2,428	2,960	16,744	1,568	940	195,108	
30	26,992		81,808	48,384	10,524	6,976	4,008	2,428	2,960	16,744	1,568	1,088	203,480	
31	25,312		81,808		10,968		4,024	2,380		15,680		1,112	141,284	
PROMEDIO DIARIO (L/S)													327,257	

Ilustración 98: Registro de Descarga Diaria del Año 1989

REGISTRO DE DESCARGA DIARIA													
RIO CHICAMA			AÑO 1990						ESTACIÓN EL TAMBO				TOTAL
Día	Enero	Febrero	Marzo	Abril	Mayo	Junio	Julio	Agosto	Septiembre	Octubre	Noviembre	Diciembre	
1	1,112	2,816	10,444	10,972	6,696	3,060	2,424	892	384	192	3,272	18,680	60,944
2	1,004	2,880	9,128	12,104	6,588	3,104	2,498	892	384	192	2,872	35,000	76,646
3	1,112	13,000	8,716	12,228	6,264	2,788	2,336	892	352	192	2,812	30,712	81,404
4	1,112	20,352	8,940	13,076	5,948	2,708	2,204	844	352	192	2,336	22,052	80,116
5	1,084	24,316	8,940	11,456	5,876	2,828	2,124	788	352	192	1,912	16,948	76,816
6	1,020	21,816	9,388	10,708	5,528	3,032	1,956	724	320	192	1,880	14,048	70,612
7	980	18,080	11,172	10,628	5,528	3,288	1,912	672	192	192	1,676	11,788	66,108
8	988	13,628	11,548	9,952	5,492	3,488	1,836	632	192	192	1,612	8,907	58,467
9	1,020	13,220	11,388	9,952	5,492	2,826	1,670	584	192	192	1,500	7,824	55,860
10	1,020	14,604	10,140	9,752	5,316	2,812	1,670	352	192	192	1,468	7,084	54,602
11	4,488	13,408	9,064	9,008	5,040	2,572	1,728	448	192	192	1,420	6,408	53,968
12	5,864	11,952	9,064	8,272	5,040	3,256	1,664	376	192	192	1,496	5,584	52,952
13	5,596	10,480	8,416	7,632	5,040	3,332	1,664	320	192	192	2,058	4,628	49,550
14	5,328	11,680	7,896	7,639	6,700	3,624	1,664	320	192	192	1,912	3,980	51,127
15	5,460	13,004	7,256	7,144	6,780	3,752	1,600	352	192	2,912	1,716	3,980	54,148
16	6,304	16,236	6,660	7,744	6,780	3,752	1,600	448	192	1,864	1,716	3,712	57,008
17	7,120	30,528	6,452	6,852	6,780	3,752	1,600	448	192	3,308	1,356	2,900	71,288
18	8,640	26,456	6,452	6,788	6,592	3,752	1,452	448	192	2,808	1,300	2,532	67,412
19	7,756	18,932	8,100	8,172	5,940	3,624	1,392	448	192	2,248	2,108	2,596	61,508
20	9,336	16,526	9,324	8,292	5,500	3,416	1,392	416	192	1,896	1,768	2,596	60,654
21	9,336	12,312	9,940	7,940	5,500	3,416	1,392	416	192	1,416	2,024	2,400	56,284
22	7,148	11,078	10,932	7,004	5,248	3,196	1,392	416	192	1,196	2,528	2,176	52,506
23	5,760	9,488	17,632	7,004	4,684	2,984	1,344	384	192	1,152	3,348	1,992	55,964
24	5,084	8,684	16,652	6,732	4,544	2,984	1,344	384	192	1,152	3,560	1,856	53,168
25	4,176	8,428	15,880	6,644	4,368	2,648	1,268	384	192	1,048	11,156	2,792	58,984
26	3,684	10,740	15,276	6,816	3,772	2,448	1,216	384	192	3,784	17,232	5,492	71,036
27	3,104	12,448	13,556	7,133	3,516	2,616	1,148	384	192	6,444	17,700	4,880	73,121
28	3,104	11,356	12,968	7,332	3,260	2,784	1,036	384	192	6,120	18,648	4,072	71,256
29	2,808		12,968	6,696	3,132	2,784	1,036	384	192	5,552	28,060	3,064	66,676
30	2,808		12,968	6,640	3,132	2,424	996	384	192	4,916	31,000	3,612	69,072
31	2,808		12,040		2,964		940	384		3,948		4,772	27,856
PROMEDIO DIARIO (L/S)													61,842

Ilustración 99: Registro de Descarga Diaria del Año 1990

REGISTRO DE DESCARGA DIARIA														
RIO CHICAMA			AÑO 1991							ESTACIÓN EL TAMBO				TOTAL
Día	Enero	Febrero	Marzo	Abril	Mayo	Junio	Julio	Agosto	Septiembre	Octubre	Noviembre	Diciembre		
1	8,880	2,260	5,008	15,440	12,832	4,760	1,588	628	304	192	2,108	1,840	55,840	
2	7,032	4,284	6,272	14,708	12,288	4,140	1,592	548	288	192	1,848	2,448	55,640	
3	5,928	4,284	8,796	12,884	13,432	3,652	1,544	548	288	192	2,352	2,580	56,480	
4	4,868	4,276	7,736	11,792	14,572	3,620	1,576	612	240	192	3,096	2,152	54,732	
5	3,740	4,428	10,856	10,328	17,596	3,504	1,584	468	224	192	2,512	1,280	56,712	
6	3,328	10,036	16,256	9,116	17,436	3,352	1,568	484	224	192	1,928	944	64,864	
7	3,060	7,484	47,510	8,752	18,252	3,072	1,440	464	240	192	1,576	736	92,778	
8	3,060	6,016	35,108	8,488	16,864	2,980	1,416	436	240	192	1,315	592	76,707	
9	2,608	4,740	25,668	9,680	16,696	2,720	1,432	420	240	192	1,172	640	66,208	
10	2,424	3,692	31,444	14,608	15,960	2,464	1,368	420	224	192	948	640	74,384	
11	1,884	3,448	42,587	15,920	14,776	2,416	1,280	420	192	192	876	576	84,567	
12	1,744	2,968	52,614	16,704	13,616	2,344	1,200	416	192	192	736	576	93,302	
13	1,596	2,504	39,736	19,688	12,984	2,328	1,172	336	192	192	656	416	81,800	
14	1,444	2,312	34,864	19,248	11,792	2,256	1,172	336	192	192	584	416	74,808	
15	1,328	2,376	33,896	19,600	10,688	2,288	1,168	388	192	192	544	416	73,076	
16	1,172	2,544	67,440	19,608	10,200	2,176	1,228	448	192	192	448	400	106,048	
17	1,024	3,316	79,510	16,800	10,236	2,016	1,188	448	192	192	448	400	115,770	
18	892	12,844	63,248	15,680	9,236	1,928	1,144	448	192	192	448	400	106,652	
19	680	15,136	48,624	17,368	8,896	1,900	1,132	440	192	192	448	368	95,376	
20	656	21,632	38,876	18,572	8,464	1,888	1,128	388	192	192	448	304	92,740	
21	504	17,160	32,612	36,888	8,208	1,812	1,128	424	192	192	448	304	99,872	
22	488	14,920	25,912	28,176	7,912	1,744	852	424	192	192	448	256	81,516	
23	1,156	12,608	26,080	24,616	7,332	1,716	832	372	192	192	448	256	75,800	
24	1,848	10,068	22,748	20,636	7,140	1,700	820	336	192	192	448	256	66,384	
25	1,648	8,624	19,512	17,916	6,728	1,616	812	336	192	192	448	256	58,280	
26	1,528	7,648	17,904	16,480	6,296	1,668	780	336	192	192	192	256	53,472	
27	1,504	6,640	17,084	16,628	5,476	1,604	764	288	192	192	192	720	51,284	
28	1,744	5,544	15,548	14,988	5,336	1,560	776	288	192	192	192	1,008	47,368	
29	2,432		15,448	13,712	4,884	1,592	772	288	192	1,832	192	12,512	53,856	
30	2,056		14,720	12,608	4,788	1,596	720	304	192	2,764	880	9,192	49,820	
31	1,840		16,836		4,872		676	304		3,044		6,912	34,484	
PROMEDIO DIARIO (L/S)													72,601	

Ilustración 100: Registro de Descarga Diaria del Año 1991

REGISTRO DE DESCARGA DIARIA														
RIO CHICAMA			AÑO 1992							ESTACIÓN EL TAMBO				TOTAL
Día	Enero	Febrero	Marzo	Abril	Mayo	Junio	Julio	Agosto	Septiembre	Octubre	Noviembre	Diciembre		
1	6,912	7,056	5,980	53,104	20,424	6,068	2,400	976	312	440	2,032	704	106,408	
2	7,104	6,232	6,032	37,488	19,760	5,836	2,400	944	316	456	1,688	632	88,888	
3	7,056	5,308	8,096	33,524	19,192	7,312	2,352	848	316	492	1,360	632	86,488	
4	6,080	4,944	7,552	33,192	19,192	8,792	2,016	780	320	492	1,136	580	85,076	
5	5,272	4,036	7,312	43,780	19,192	8,356	1,948	756	320	468	1,136	608	93,184	
6	4,660	3,736	6,772	43,780	19,192	7,540	1,924	784	256	528	1,048	464	90,684	
7	6,800	3,608	10,432	34,236	18,384	7,172	1,820	820	400	624	916	448	85,660	
8	16,896	3,660	24,392	27,780	26,344	8,220	1,852	828	336	1,416	800	576	113,100	
9	18,240	3,320	48,768	23,972	22,524	8,020	1,948	696	320	1,440	800	400	130,448	
10	12,384	3,984	32,640	19,896	20,800	7,508	1,856	696	332	1,712	736	352	102,896	
11	9,888	4,992	23,960	19,896	19,064	7,336	1,756	636	336	1,800	656	312	90,632	
12	8,272	3,900	19,928	24,244	17,472	6,844	1,780	620	320	2,340	656	536	86,912	
13	7,432	3,592	19,568	65,140	15,880	6,156	1,756	596	332	2,632	592	480	124,156	
14	7,136	3,092	30,536	123,704	14,988	5,608	1,756	528	332	2,388	512	416	190,996	
15	5,616	2,804	22,680	105,956	14,372	5,068	1,644	512	320	2,040	496	416	161,924	
16	4,456	2,600	31,120	85,804	13,620	4,932	1,628	452	300	1,592	448	400	147,352	
17	3,624	2,472	34,652	62,084	12,916	4,580	1,568	384	328	1,296	304	400	124,608	
18	2,936	2,412	28,992	56,480	12,916	4,508	1,576	360	316	1,176	272	400	112,344	
19	2,584	3,240	23,876	49,704	11,828	4,456	1,576	288	300	1,092	272	400	99,616	
20	2,128	3,468	28,992	45,496	11,136	4,560	1,484	304	280	912	272	560	99,592	
21	2,080	3,104	35,192	39,996	10,660	4,052	1,416	316	280	776	272	432	98,576	
22	2,008	2,948	23,876	33,624	10,480	3,892	1,196	304	276	624	288	416	79,932	
23	3,848	2,444	21,000	31,628	10,032	3,772	1,124	268	272	660	560	400	76,008	
24	14,720	2,124	16,848	30,408	9,192	3,588	1,036	268	272	468	832	400	80,156	
25	11,280	2,100	14,996	26,580	9,192	3,496	1,020	288	272	468	736	352	70,780	
26	14,544	1,848	14,620	23,592	8,528	3,296	1,008	288	312	468	592	448	69,544	
27	16,208	1,752	12,288	22,364	8,416	2,896	1,004	288	312	524	656	1,372	68,080	
28	12,848	2,348	11,192	22,808	8,082	2,588	976	288	312	2,080	736	1,344	65,602	
29	10,144	8,040	9,948	22,428	7,480	2,364	976	288	376	4,200	664	1,248	68,156	
30	8,832		11,692	20,982	6,740	2,400	976	288	372	3,280	744	844	57,150	
31	8,096		28,640		6,240		976	264		2,624		736	47,576	
PROMEDIO DIARIO (L/S)													96,856	

Ilustración 101: Registro de Descarga Diaria del Año 1992

REGISTRO DE DESCARGA DIARIA														
RIO CHICAMA			AÑO 1993							ESTACIÓN EL TAMBO				TOTAL
Día	Enero	Febrero	Marzo	Abril	Mayo	Junio	Julio	Agosto	Septiembre	Octubre	Noviembre	Diciembre		
1	544	7,912	70,344	123,632	47,440	20,296	6,824	4,036	2,100	7,204	15,860	4,160	310,352	
2	528	33,600	91,408	109,280	45,268	19,256	6,932	3,920	2,076	6,456	12,744	3,864	335,332	
3	608	45,356	91,936	93,040	42,616	18,380	6,976	3,964	2,128	5,532	12,452	3,572	326,560	
4	660	36,456	105,536	84,512	43,580	16,656	6,988	3,968	1,936	4,864	24,708	3,520	333,384	
5	544	50,732	123,888	82,384	42,244	16,692	6,908	3,628	1,968	4,752	28,340	3,340	365,420	
6	560	57,016	119,640	74,160	39,520	15,492	6,800	3,520	1,664	4,412	26,428	3,624	352,836	
7	448	49,648	103,064	77,296	37,412	14,864	6,784	3,384	1,736	3,376	22,476	6,600	327,088	
8	512	34,656	87,808	77,488	36,668	14,244	6,712	3,384	1,604	3,020	20,580	7,240	293,916	
9	512	40,916	100,380	76,864	36,040	13,244	6,540	3,060	1,632	2,852	20,496	6,368	308,904	
10	544	47,464	97,528	78,016	35,304	12,808	6,380	2,856	1,648	2,612	36,240	6,116	327,516	
11	484	58,176	107,168	169,392	33,936	12,392	6,368	2,624	1,764	2,360	57,912	8,300	460,876	
12	416	78,400	80,000	129,120	32,252	11,928	6,180	2,568	1,768	1,984	36,000	13,232	393,848	
13	400	62,144	84,848	109,184	30,348	11,312	6,012	2,684	1,928	2,008	26,888	11,196	348,952	
14	400	58,968	79,392	118,224	28,544	10,872	5,748	2,320	1,880	1,904	22,024	9,896	340,172	
15	692	57,576	72,032	100,192	26,496	10,504	5,588	2,404	1,960	1,968	19,292	10,524	309,228	
16	836	59,560	71,744	86,496	25,588	10,384	5,512	2,428	1,960	3,328	16,000	11,212	295,048	
17	720	50,804	53,272	140,960	25,228	9,980	5,292	2,428	1,864	3,064	13,548	16,232	323,392	
18	648	38,400	54,456	155,184	24,912	9,720	5,352	2,404	1,708	3,140	11,640	22,208	329,772	
19	624	31,400	92,800	167,712	24,520	9,316	5,352	2,364	2,200	3,708	10,112	18,420	368,528	
20	688	26,904	76,672	177,184	24,216	9,056	5,192	2,408	2,080	3,912	8,344	16,448	353,104	
21	704	24,632	105,824	144,880	23,752	8,496	4,988	2,408	2,080	5,752	7,620	14,848	345,984	
22	608	20,772	105,920	122,608	22,752	8,224	4,988	2,304	1,716	6,264	6,444	13,008	315,608	
23	584	18,496	101,104	93,024	22,336	7,944	4,900	2,240	1,708	6,104	5,752	16,392	280,584	
24	524	16,216	118,080	71,184	21,248	7,568	4,756	2,208	1,688	5,332	5,120	28,428	282,352	
25	624	14,920	134,112	70,160	19,244	7,236	4,756	2,160	1,736	4,812	5,068	46,736	311,564	
26	2,896	14,920	142,736	61,832	18,888	7,292	4,368	2,148	1,164	4,316	5,068	44,040	309,668	
27	2,896	14,920	297,936	62,864	17,988	7,504	3,956	2,124	1,152	4,100	4,928	32,448	452,816	
28	4,084	14,920	297,728	55,736	17,232	7,300	4,016	2,088	1,596	6,228	4,632	32,584	448,144	
29	6,760		199,552	49,280	17,468	7,224	4,028	2,188	9,088	12,316	4,520	47,060	359,484	
30	7,428		190,464	48,464	18,140	7,104	4,088	2,220	7,880	23,344	4,472	42,612	356,216	
31	7,688		154,608		18,816		4,148	2,224		19,748		37,332	244,564	
PROMEDIO DIARIO (L/S)													339,071	

Ilustración 102: Registro de Descarga Diaria del Año 1993

REGISTRO DE DESCARGA DIARIA														
RIO CHICAMA			AÑO 1994							ESTACIÓN EL TAMBO				TOTAL
Día	Enero	Febrero	Marzo	Abril	Mayo	Junio	Julio	Agosto	Septiembre	Octubre	Noviembre	Diciembre		
1	35,080	45,292	50,960	104,656	51,000	18,604	8,692	4,380	2,384	3,060	1,364	1,344	326,816	
2	33,648	42,172	43,560	105,152	45,128	17,916	8,432	4,432	2,236	2,732	1,328	1,292	308,028	
3	57,356	40,552	50,900	115,784	41,684	17,372	8,432	4,432	2,236	2,732	1,344	1,236	344,060	
4	56,440	46,816	46,660	121,824	37,240	16,660	8,116	4,432	2,184	2,656	1,360	1,580	345,968	
5	45,912	72,728	44,108	109,496	35,944	16,176	8,020	4,340	2,184	2,588	1,904	1,560	344,960	
6	47,464	94,840	45,036	104,504	34,864	15,816	7,916	4,248	2,184	2,540	3,304	1,560	364,276	
7	35,280	87,032	56,920	117,800	34,276	15,544	7,460	4,092	2,184	2,540	2,852	1,560	367,540	
8	32,920	70,756	52,380	167,572	33,468	14,692	7,244	4,092	2,304	2,484	2,616	1,896	392,424	
9	32,172	69,384	50,316	101,564	30,156	14,108	7,088	4,064	2,272	2,456	7,212	1,864	322,656	
10	30,536	67,420	48,596	88,716	31,012	13,704	7,004	3,916	2,088	2,176	7,088	1,820	304,076	
11	35,212	72,904	45,556	80,976	30,112	13,152	6,820	3,812	1,996	2,096	7,244	1,484	301,364	
12	43,896	74,588	44,700	69,128	27,452	12,104	6,760	3,708	1,920	2,128	7,872	1,528	295,784	
13	45,944	68,232	47,252	66,772	27,340	11,572	6,760	3,556	1,868	2,108	6,664	1,528	289,596	
14	40,000	62,880	78,060	63,632	25,764	11,428	6,496	3,296	1,812	2,168	4,832	1,604	301,972	
15	36,396	85,132	74,184	57,592	25,004	11,380	6,184	3,224	1,812	2,264	5,596	1,604	310,372	
16	45,508	67,920	71,648	52,884	24,432	11,060	6,028	3,048	1,784	1,864	4,392	1,432	292,000	
17	41,208	66,760	61,828	46,900	23,924	10,712	5,616	3,072	1,720	1,768	3,728	1,352	268,588	
18	40,208	64,836	58,660	42,492	23,148	10,368	5,580	3,072	1,812	1,736	3,344	1,316	256,572	
19	38,904	51,364	68,160	39,896	22,900	10,024	5,552	3,072	1,812	1,648	2,964	1,800	248,096	
20	46,564	51,816	55,296	38,568	21,748	9,676	5,552	3,120	1,904	1,588	2,824	5,444	244,100	
21	52,088	68,440	50,208	38,484	21,000	9,128	5,396	3,120	1,880	1,588	2,668	11,480	265,480	
22	54,924	86,240	45,568	37,376	19,928	9,064	5,304	3,016	1,848	1,628	2,424	9,968	277,288	
23	54,924	92,392	43,496	37,272	19,540	9,020	5,184	2,840	1,848	1,608	2,412	9,188	279,724	
24	54,168	69,676	46,012	35,516	17,812	8,928	5,048	2,840	1,848	1,608	2,132	11,120	256,708	
25	48,108	64,708	43,756	34,644	19,072	8,716	4,948	2,764	1,948	1,608	1,884	12,740	244,896	
26	43,572	58,648	41,896	35,804	19,928	8,176	4,884	2,668	2,004	1,640	1,600	10,944	231,764	
27	40,036	55,276	42,388	35,248	20,404	8,288	4,884	2,632	2,348	1,616	1,500	13,804	228,424	
28	37,468	53,148	56,060	34,636	19,636	8,628	4,764	2,576	2,788	1,528	1,404	15,512	238,148	
29	45,244		63,584	38,460	19,308	8,704	4,428	2,492	2,688	1,468	1,440	12,084	199,900	
30	52,896		105,812	41,512	18,940	8,588	4,340	2,492	2,968	1,468	1,440	10,276	250,732	
31	45,240		123,060		19,060		4,340	2,416		1,396		8,884	204,396	
PROMEDIO DIARIO (L/S)													287,313	

Ilustración 103: Registro de Descarga Diaria del Año 1994

REGISTRO DE DESCARGA DIARIA													
RIO CHICAMA			AÑO 1995						ESTACIÓN EL TAMBO				TOTAL
Día	Enero	Febrero	Marzo	Abril	Mayo	Junio	Julio	Agosto	Septiembre	Octubre	Noviembre	Diciembre	
1	8,440	14,872	23,644	24,360	13,544	6,404	3,460	2,728	1,120	880	1,256	1,336	102,044
2	11,008	26,824	22,172	25,168	13,068	6,156	3,460	2,728	1,096	836	3,160	1,120	116,796
3	15,384	38,624	19,616	30,900	13,068	5,804	3,460	2,728	1,096	836	4,824	912	137,252
4	15,780	32,044	17,756	30,492	12,788	5,620	3,460	2,656	1,064	816	4,108	912	127,496
5	12,744	33,080	16,448	28,264	12,500	5,348	3,460	2,488	1,064	816	3,248	864	120,324
6	11,252	38,184	15,316	26,416	12,500	5,152	3,408	2,264	1,036	816	2,800	920	120,064
7	10,644	28,804	14,680	23,400	12,280	5,152	3,176	2,128	980	816	2,688	920	105,668
8	10,644	25,372	15,236	22,400	11,804	5,032	3,148	2,128	1,016	816	2,596	920	101,112
9	11,552	22,568	16,540	49,892	11,804	5,032	3,148	2,088	940	800	3,608	848	128,820
10	9,976	19,212	16,172	61,848	11,804	4,952	3,040	1,920	940	800	5,376	848	136,888
11	8,508	16,140	16,228	57,984	11,804	4,784	2,949	1,840	912	784	5,264	848	128,045
12	8,048	17,256	16,748	49,644	11,388	4,688	2,860	1,840	856	844	4,960	620	119,752
13	6,712	15,416	36,220	48,668	10,888	4,520	2,932	1,840	1,004	844	4,688	620	134,352
14	5,888	17,312	35,476	48,668	10,092	4,436	2,840	1,840	1,060	844	4,536	620	133,612
15	5,252	19,132	27,148	42,872	9,364	4,436	2,744	1,764	1,136	696	5,400	620	120,564
16	5,064	19,132	23,872	41,744	9,132	4,120	2,744	1,716	1,060	672	5,016	672	114,944
17	4,508	17,272	22,628	37,952	8,912	4,072	2,680	1,716	1,020	656	6,760	620	108,796
18	4,556	18,864	20,828	41,728	8,500	3,960	2,680	1,648	944	720	6,376	620	111,424
19	4,800	20,548	24,704	36,344	8,156	3,592	2,680	1,648	856	692	5,892	672	110,584
20	4,652	24,332	30,208	31,968	8,020	3,592	2,680	1,648	856	672	5,048	696	114,372
21	4,432	46,684	29,096	28,644	7,712	3,592	2,680	1,648	880	672	4,568	712	131,320
22	4,124	77,272	28,048	26,256	7,376	3,592	2,608	1,648	892	544	4,340	652	157,352
23	3,888	60,876	43,456	23,928	7,376	3,592	2,536	1,648	784	544	3,896	620	153,144
24	3,744	44,032	37,392	21,928	7,376	3,592	2,464	1,568	756	544	3,228	7,136	133,760
25	5,992	35,480	34,056	21,120	7,576	3,592	2,480	1,496	756	544	2,732	10,720	126,544
26	7,384	30,416	30,976	19,224	7,676	3,460	2,624	1,280	772	568	2,292	12,548	119,220
27	9,984	26,920	28,244	17,628	7,676	3,460	2,624	1,232	944	568	2,168	14,368	115,816
28	9,984	24,188	26,772	16,004	7,676	3,460	2,624	1,176	836	752	2,048	22,076	117,596
29	12,084		25,848	14,856	7,336	3,460	2,624	1,176	844	872	1,740	20,760	91,600
30	11,944		24,640	14,168	7,336	3,460	2,624	1,176	880	688	1,464	21,500	89,880
31	11,432		25,404		6,740		2,584	1,120		872		24,288	72,440
PROMEDIO DIARIO (L/S)													119,406

Ilustración 104: Registro de Descarga Diaria del Año 1995

REGISTRO DE DESCARGA DIARIA													
RIO CHICAMA			AÑO 1996						ESTACIÓN EL TAMBO				TOTAL
Día	Enero	Febrero	Marzo	Abril	Mayo	Junio	Julio	Agosto	Septiembre	Octubre	Noviembre	Diciembre	
1	18,864	10,952	62,728	83,072	28,096	10,176	5,184	2,804	1,712	1,056	3,344	432	228,420
2	16,108	12,276	105,836	84,656	26,064	10,000	5,184	2,956	1,756	1,088	4,368	400	270,692
3	15,536	28,360	101,540	95,472	25,072	10,224	5,144	2,856	1,736	1,168	7,344	560	295,012
4	16,952	31,728	125,028	94,864	24,144	10,896	5,176	2,856	1,776	1,248	7,696	560	322,924
5	22,460	32,868	119,076	99,904	22,624	10,896	5,424	2,856	1,724	1,264	7,696	464	327,256
6	34,764	29,888	98,136	85,200	21,344	10,656	5,264	2,832	1,744	1,248	7,344	568	298,988
7	33,344	27,032	65,712	73,568	19,584	10,112	5,148	2,872	1,712	1,232	7,568	624	248,508
8	32,352	22,344	63,872	56,336	19,104	9,792	5,068	2,856	1,736	1,264	6,832	568	222,124
9	34,248	19,040	56,276	52,080	18,592	9,616	4,540	2,792	1,736	1,264	5,912	592	206,688
10	40,636	19,752	69,716	51,152	17,904	9,200	4,372	2,720	1,720	3,392	5,152	704	226,420
11	49,648	32,080	94,872	56,480	17,280	8,752	4,468	2,656	1,680	5,968	4,096	800	278,780
12	54,460	47,612	117,212	57,040	16,864	8,496	4,564	2,556	1,656	5,392	3,816	752	320,420
13	54,460	56,844	125,504	57,344	16,976	8,336	4,564	2,484	1,584	4,496	3,400	752	336,744
14	45,328	45,648	141,320	56,208	16,800	8,144	4,444	2,312	1,704	3,680	2,880	640	329,108
15	36,224	42,640	158,816	56,544	16,944	7,648	4,340	2,176	1,728	3,056	2,160	448	332,724
16	30,228	45,276	147,244	52,144	16,816	7,248	4,228	2,176	1,600	2,960	1,712	552	312,184
17	24,376	71,664	123,744	51,232	15,344	6,912	4,156	2,192	1,568	3,312	1,584	600	306,684
18	21,260	75,304	155,820	46,336	15,216	6,512	4,052	2,068	1,592	3,344	1,376	416	333,296
19	18,808	75,660	121,132	44,336	14,608	6,288	4,004	2,028	1,448	3,152	1,296	464	293,224
20	16,572	117,668	85,024	43,968	14,128	6,080	3,796	1,888	1,376	2,992	1,088	672	295,252
21	15,480	112,704	76,376	44,624	13,664	5,984	3,640	1,976	1,264	2,816	1,088	512	280,128
22	14,784	82,560	71,448	42,688	14,336	5,920	3,352	2,008	1,216	2,864	896	352	242,424
23	12,496	73,056	86,640	38,832	13,552	5,920	3,272	2,020	1,144	2,768	832	352	240,884
24	11,340	58,340	95,920	34,800	12,448	5,808	3,112	2,020	1,108	2,944	704	544	229,088
25	9,756	49,744	96,640	33,696	12,240	5,648	3,140	2,036	1,156	3,184	672	544	218,456
26	9,472	44,732	87,824	33,792	11,952	5,632	2,940	2,064	1,120	3,376	640	544	204,088
27	9,472	41,124	79,040	33,136	11,744	5,408	3,124	2,016	1,088	3,264	608	496	190,520
28	9,912	39,792	69,104	31,824	11,520	5,312	3,072	1,924	1,104	3,152	608	496	177,820
29	10,364	43,704	73,424	29,744	11,424	5,232	2,972	1,856	1,104	3,024	496	496	183,840
30	9,672		88,896	31,040	11,296	5,184	2,844	1,808	1,012	2,816	496	688	155,752
31	8,872		88,336		10,832		2,804	1,764		3,000		672	116,280
PROMEDIO DIARIO (L/S)													258,862

Ilustración 105: Registro de Descarga Diaria del Año 1996

REGISTRO DE DESCARGA DIARIA														
RIO CHICAMA			AÑO 1997						ESTACIÓN EL TAMBO					TOTAL
Día	Enero	Febrero	Marzo	Abril	Mayo	Junio	Julio	Agosto	Septiembre	Octubre	Noviembre	Diciembre		
1	608	1,872	23,136	5,088	20,208	3,312	1,840	432	144	240	2,704	16,512	76,096	
2	608	1,760	23,136	4,912	18,016	3,312	1,744	272	160	240	2,224	13,648	70,032	
3	704	1,440	19,408	4,096	16,400	3,360	1,744	272	144	368	2,336	12,240	62,512	
4	688	1,376	16,064	3,392	14,688	3,152	1,744	320	176	448	5,984	13,008	61,040	
5	688	1,072	13,568	3,104	14,016	3,344	1,680	320	144	400	5,088	16,832	60,256	
6	688	1,008	13,568	2,912	12,208	2,800	1,680	320	144	400	5,808	16,240	57,776	
7	816	1,008	12,624	2,592	10,240	2,800	1,344	320	144	320	6,896	13,392	52,496	
8	912	1,344	10,768	2,496	9,472	2,560	1,312	352	144	336	5,552	11,120	46,368	
9	912	2,624	10,768	2,368	8,256	2,624	1,264	352	144	272	4,912	12,240	46,736	
10	880	11,736	11,064	2,288	7,424	2,464	1,264	352	144	272	4,784	20,912	63,584	
11	960	13,304	11,168	2,048	6,992	2,640	1,200	320	144	272	4,784	45,200	89,032	
12	896	22,160	10,736	1,888	7,440	2,640	1,264	320	144	272	5,136	43,600	96,496	
13	1,104	25,648	9,584	1,888	7,520	2,160	1,264	256	144	208	6,384	36,800	92,960	
14	1,152	18,720	8,672	2,384	7,216	2,096	1,056	352	144	224	4,496	31,760	78,272	
15	1,152	13,344	8,144	5,552	8,032	1,936	1,072	272	144	224	4,112	34,880	78,864	
16	1,152	10,592	13,760	5,824	6,994	1,936	1,072	272	144	240	3,424	32,544	77,954	
17	1,152	11,336	14,688	9,200	6,832	2,032	1,120	240	144	288	2,752	49,600	99,384	
18	2,032	13,440	17,952	10,496	6,112	1,936	1,056	240	144	288	2,304	70,112	126,112	
19	2,112	17,648	23,120	10,496	5,664	2,144	912	240	144	288	1,600	110,192	174,560	
20	1,904	21,712	21,616	10,384	5,264	2,144	576	240	144	288	1,600	112,416	178,288	
21	1,920	24,016	17,616	8,544	5,024	2,144	752	240	160	288	1,600	77,856	140,160	
22	1,744	31,888	15,264	8,448	4,560	2,256	576	240	160	240	960	72,400	138,736	
23	1,424	29,920	14,288	9,824	4,368	2,256	560	240	160	240	960	62,752	126,992	
24	1,200	26,032	12,800	12,000	4,080	2,032	512	240	160	240	704	52,224	112,224	
25	1,200	31,984	11,204	14,496	3,568	1,936	512	240	160	240	3,136	47,088	115,764	
26	992	33,392	9,696	22,608	3,344	2,144	512	240	160	240	16,528	47,104	136,960	
27	992	27,728	8,832	24,176	4,240	2,144	464	240	160	240	12,848	64,864	146,928	
28	992	24,960	8,192	20,368	4,368	2,032	464	240	160	1,328	12,960	70,576	146,640	
29	1,888		7,504	17,488	4,176	1,840	416	240	160	3,456	12,880	60,240	110,288	
30	2,464		6,592	18,576	3,844	1,744	416	240	160	3,152	14,544	67,040	118,772	
31	2,384		5,760		3,584		432	144		2,784		81,264	96,352	
PROMEDIO DIARIO (L/S)													99,311	

Ilustración 106: Registro de Descarga Diaria del Año 1997

REGISTRO DE DESCARGA DIARIA														
RIO CHICAMA			AÑO 1998							ESTACIÓN EL TAMBO				TOTAL
Día	Enero	Febrero	Marzo	Abril	Mayo	Junio	Julio	Agosto	Septiembre	Octubre	Noviembre	Diciembre		
1	102,048	279,104	252,512	496,672	68,640	24,080	14,960	9,312	6,624	5,648	8,672	4,544	1,272,816	
2	83,504	244,784	237,616	348,560	66,560	25,424	14,448	9,472	6,464	5,648	8,880	4,544	1,055,904	
3	65,600	231,488	204,176	299,952	80,160	28,576	14,064	9,008	6,368	5,472	8,864	4,544	958,272	
4	52,016	262,944	398,560	268,880	79,024	26,336	14,320	9,136	6,368	5,312	8,512	4,544	1,135,952	
5	42,608	270,448	446,896	286,224	62,976	23,136	14,336	8,288	6,400	5,056	7,584	4,304	1,178,256	
6	40,208	323,296	461,520	326,176	64,160	22,160	14,304	7,904	6,368	4,672	7,120	4,304	1,282,192	
7	62,880	361,856	469,920	279,760	89,936	21,216	13,280	7,872	6,208	4,832	6,592	4,144	1,328,496	
8	88,064	349,184	486,560	242,400	73,648	21,536	13,200	7,552	6,208	4,736	6,368	4,144	1,303,600	
9	86,624	384,816	428,448	226,944	79,120	20,816	13,072	7,552	6,048	4,736	5,648	4,144	1,267,968	
10	58,928	1,500,000	496,556	314,880	74,688	19,840	13,008	7,600	6,048	4,736	5,648	4,144	2,506,076	
11	55,872	1,200,000	527,936	400,416	63,536	19,648	13,808	7,600	6,144	4,736	5,280	4,208	2,309,184	
12	61,616	804,832	803,456	455,552	56,944	19,376	13,808	7,728	6,800	4,736	4,960	4,144	2,243,952	
13	67,328	496,832	706,512	375,760	59,920	19,280	13,808	7,808	7,232	5,344	4,960	3,312	1,768,096	
14	75,200	491,232	460,576	337,680	58,112	18,720	13,728	7,936	7,072	6,000	4,960	3,312	1,484,528	
15	79,888	332,192	496,896	230,608	52,928	18,400	13,088	7,760	6,992	5,760	4,960	3,360	1,252,832	
16	81,488	249,632	704,800	231,568	50,080	18,288	13,008	7,760	6,992	5,680	4,960	3,728	1,377,984	
17	77,472	253,728	708,560	165,872	44,032	19,024	12,832	7,792	6,912	5,264	6,192	4,112	1,311,792	
18	184,848	172,176	731,200	151,056	43,200	17,824	11,888	7,792	6,208	5,056	7,088	4,112	1,342,448	
19	123,168	253,600	752,784	211,536	39,808	17,600	11,744	7,824	6,048	4,944	6,864	5,984	1,441,904	
20	126,192	173,408	759,472	143,264	37,088	18,032	11,456	7,824	6,048	5,328	6,656	4,944	1,299,712	
21	100,544	254,240	806,528	102,080	33,808	17,504	11,296	7,632	6,048	5,072	6,272	4,944	1,355,968	
22	107,360	286,480	748,432	82,496	32,416	17,536	10,704	7,312	6,048	5,376	5,488	4,832	1,314,480	
23	282,752	812,192	750,704	81,584	30,672	17,376	10,272	7,312	5,712	6,544	4,976	5,040	2,015,136	
24	116,256	414,576	753,632	80,480	30,127	16,400	10,272	7,248	6,016	6,928	5,136	5,184	1,452,255	
25	345,344	496,912	659,584	69,376	28,944	16,432	9,744	7,136	6,016	8,192	4,848	5,184	1,657,712	
26	238,576	1,000,000	625,344	95,936	28,176	16,384	10,160	6,720	6,016	11,712	4,848	4,880	2,048,752	
27	205,120	251,568	479,600	72,720	27,216	15,632	9,488	6,720	6,016	14,112	4,848	4,592	1,097,632	
28	192,064	251,136	313,232	66,256	26,592	15,568	9,424	6,704	6,016	12,096	4,848	4,416	908,352	
29	420,864		318,352	56,544	26,592	15,696	9,424	6,704	5,712	10,016	4,848	4,416	879,168	
30	433,248		503,744	62,608	26,080	14,960	9,360	6,704	5,568	9,056	4,848	5,696	1,081,872	
31	429,856		497,168		24,048		9,280	6,704		8,528		9,712	985,296	
PROMEDIO DIARIO (L/S)													1,416,729	

Ilustración 107: Registro de Descarga Diaria del Año 1998

REGISTRO DE DESCARGA DIARIA														
RIO CHICAMA			AÑO 1999						ESTACIÓN EL TAMBO				TOTAL	
Día	Enero	Febrero	Marzo	Abril	Mayo	Junio	Julio	Agosto	Septiembre	Octubre	Noviembre	Diciembre		
1	12,160	25,264	126,192	43,152	30,128	20,432	13,456	7,344	5,280	10,256	4,176	5,184	303,024	
2	10,176	26,816	155,568	42,560	31,024	19,872	13,648	7,232	4,896	12,240	4,048	5,136	333,216	
3	8,736	25,472	109,744	41,712	44,160	19,712	13,616	6,992	4,992	11,440	3,904	5,056	295,536	
4	8,032	23,840	96,000	53,200	51,344	18,976	13,184	6,848	4,992	11,984	3,776	6,080	298,256	
5	7,600	28,832	75,408	55,936	66,464	18,576	13,536	6,848	4,880	11,616	3,536	6,144	299,376	
6	6,784	41,264	72,848	55,856	78,176	17,472	13,536	6,656	4,880	12,720	3,536	7,408	321,136	
7	6,464	38,944	64,368	69,872	55,344	18,528	13,792	6,464	4,880	12,896	3,456	7,408	302,416	
8	5,984	32,112	63,120	61,328	48,256	18,368	13,424	6,384	4,800	13,872	3,296	6,912	277,856	
9	5,600	26,816	58,000	64,560	44,016	18,288	13,424	6,336	4,752	12,304	3,296	6,464	263,856	
10	4,480	31,264	51,616	61,600	39,472	18,208	12,608	6,384	4,672	10,448	3,296	8,848	252,896	
11	4,480	30,288	51,312	59,456	34,304	17,696	12,448	6,336	4,784	9,232	3,120	9,696	243,152	
12	4,480	50,704	44,560	56,640	34,768	17,152	12,208	6,224	4,864	8,496	3,072	9,488	252,656	
13	4,480	62,320	42,688	57,904	33,760	16,960	12,208	6,112	6,320	7,568	2,976	9,264	262,560	
14	4,480	64,016	37,712	59,392	33,152	15,808	11,776	6,112	6,688	7,008	2,976	9,776	258,896	
15	6,288	81,168	49,472	58,448	32,240	15,808	11,456	6,048	6,528	6,912	2,752	11,616	288,736	
16	6,464	117,424	86,608	54,896	31,824	15,808	10,512	6,048	6,528	6,480	2,848	12,112	357,552	
17	5,904	131,296	70,912	46,368	30,912	15,328	9,872	6,336	6,256	5,568	2,736	11,888	343,376	
18	5,776	199,312	99,456	45,120	30,976	15,328	9,520	6,272	6,656	5,120	2,736	11,072	437,344	
19	5,792	220,288	87,232	44,032	30,848	14,656	9,416	5,808	8,480	4,976	3,168	9,936	444,632	
20	6,368	260,032	76,704	42,160	30,912	15,088	9,360	5,664	8,352	5,168	7,856	10,736	478,400	
21	7,504	208,912	70,960	38,400	27,504	14,448	9,280	5,520	7,312	5,120	7,936	14,208	417,104	
22	9,168	313,152	68,608	35,472	27,008	14,768	8,864	5,360	6,976	4,912	6,960	29,680	530,928	
23	12,360	288,144	65,872	34,976	26,960	14,576	8,784	5,264	8,656	4,672	6,704	26,352	503,320	
24	10,208	240,048	72,448	32,816	23,792	14,576	8,432	5,344	8,448	4,672	5,856	20,416	447,056	
25	8,896	193,344	66,784	31,712	23,024	14,816	8,320	5,504	8,288	4,384	5,024	16,432	386,528	
26	16,640	195,248	59,984	32,304	26,672	14,656	8,080	5,456	8,016	5,776	4,496	14,864	392,192	
27	25,776	200,992	53,248	33,008	25,792	14,656	8,272	5,456	8,080	5,760	4,336	13,328	398,704	
28	27,504	135,904	50,448	30,992	25,616	14,208	8,544	5,456	9,376	5,360	5,504	13,328	332,240	
29	38,672		57,808	29,936	22,496	13,968	8,192	5,456	9,152	4,928	5,376	13,184	209,168	
30	34,880		49,904	28,400	20,912	13,776	8,192	5,392	9,024	4,480	5,232	12,112	192,304	
31	33,376		46,880		20,608		7,712	5,328		4,368		10,912	129,184	
PROMEDIO DIARIO (L/S)													330,761	

Ilustración 108: Registro de Descarga Diaria del Año 1999

REGISTRO DE DESCARGA DIARIA														
RIO CHICAMA			AÑO 2000							ESTACIÓN EL TAMBO				TOTAL
Día	Enero	Febrero	Marzo	Abril	Mayo	Junio	Julio	Agosto	Septiembre	Octubre	Noviembre	Diciembre		
1	10,400	20,224	147,616	152,848	136,272	20,832	13,008	7,312	5,392	7,376	2,688	4,976	528,944	
2	10,400	29,936	141,152	172,848	117,504	20,528	12,752	7,104	5,280	6,624	2,688	6,192	533,008	
3	10,704	28,768	133,632	154,432	109,296	19,152	12,640	7,232	5,104	6,512	2,688	10,752	500,912	
4	10,704	38,688	120,000	159,472	100,288	18,224	11,888	7,136	5,104	6,208	2,688	11,120	491,520	
5	10,352	52,352	112,640	172,384	102,192	18,000	11,616	7,136	5,216	5,680	2,688	12,000	512,256	
6	9,296	53,520	159,984	176,896	96,896	19,040	11,264	7,136	5,392	5,584	2,688	10,688	558,384	
7	8,928	60,480	183,904	164,656	96,208	18,512	10,896	7,136	5,360	5,104	2,496	9,408	573,088	
8	8,256	42,592	244,704	156,800	90,592	18,432	10,288	7,136	5,152	5,008	2,448	11,568	602,976	
9	7,616	59,192	309,984	161,744	88,240	18,112	10,288	6,928	5,104	5,584	2,480	19,264	694,536	
10	7,200	44,096	303,200	161,984	89,312	16,896	10,128	6,800	5,056	6,720	2,288	24,752	678,432	
11	6,384	40,448	295,952	154,608	84,080	16,736	9,936	7,104	5,056	6,416	2,288	18,896	647,904	
12	6,064	42,144	297,200	165,392	79,920	16,656	10,048	7,024	5,120	6,080	2,288	16,160	654,096	
13	5,984	33,152	297,920	160,160	69,840	16,320	9,888	6,832	4,992	5,696	2,096	12,592	625,472	
14	5,456	27,728	274,480	152,208	76,176	15,744	9,680	6,704	5,040	5,264	2,016	10,288	590,784	
15	5,248	24,016	278,384	148,016	73,456	15,536	9,520	6,656	4,992	4,928	2,048	9,120	581,920	
16	5,120	22,768	257,952	146,064	64,960	15,344	9,520	6,656	4,880	4,752	2,048	8,224	548,288	
17	4,880	22,516	250,688	149,024	57,184	15,264	9,360	6,480	5,680	4,688	2,048	7,680	535,492	
18	4,768	24,384	232,960	146,144	56,048	15,232	9,488	6,144	6,672	4,592	2,000	7,280	515,712	
19	4,688	43,904	206,912	147,888	51,648	15,184	9,472	5,824	6,320	4,288	1,968	7,408	505,504	
20	4,944	43,600	192,512	154,608	48,480	15,040	9,408	5,872	6,016	4,032	1,968	8,224	494,704	
21	6,256	50,816	148,576	159,088	43,264	14,880	9,264	5,872	5,808	3,936	1,968	7,392	457,120	
22	7,488	78,816	149,152	153,952	38,320	14,752	9,152	5,776	5,952	3,744	1,968	7,200	476,272	
23	7,296	88,448	138,144	151,120	36,960	14,592	8,800	5,728	5,536	3,568	1,968	6,784	468,944	
24	7,616	83,408	129,600	151,664	34,256	14,592	8,720	5,728	5,584	3,488	2,112	6,240	453,008	
25	7,328	78,592	123,136	154,208	29,952	14,432	8,928	5,520	5,552	3,216	2,112	5,488	438,464	
26	6,512	92,720	145,456	147,552	27,440	14,096	8,832	5,280	6,064	3,152	2,112	5,488	464,704	
27	7,072	99,984	128,448	141,664	24,832	13,952	7,968	5,408	6,016	3,120	2,112	4,912	445,488	
28	17,536	122,784	107,328	139,968	23,232	13,792	7,952	5,520	5,744	2,880	2,272	4,336	453,344	
29	21,392	147,824	101,248	135,792	22,992	13,536	7,952	5,520	5,776	2,800	2,928	6,800	474,560	
30	19,856		153,952	143,472	22,464	13,248	7,840	5,600	6,496	2,688	4,080	10,992	390,688	
31	20,224		137,856		21,632		7,600	5,648		2,688		13,840	209,488	
PROMEDIO DIARIO (L/S)													519,549	

Ilustración 109: Registro de Descarga Diaria del Año 2000

REGISTRO DE DESCARGA DIARIA														
RIO CHICAMA			AÑO 2001							ESTACIÓN EL TAMBO				TOTAL
Día	Enero	Febrero	Marzo	Abril	Mayo	Junio	Julio	Agosto	Septiembre	Octubre	Noviembre	Diciembre		
1	13,600	54,912	57,744	234,880	29,392	20,000	11,104	7,216	4,704	4,464	10,128	18,448	466,592	
2	20,368	57,952	52,656	255,600	27,776	20,224	10,832	7,024	4,704	4,208	11,840	16,112	489,296	
3	22,400	71,840	52,912	215,952	29,760	19,472	10,720	6,768	4,704	4,112	8,752	13,680	461,072	
4	18,416	93,296	75,584	188,384	27,072	18,816	10,256	240	4,608	3,936	7,648	12,496	460,752	
5	21,024	82,640	83,664	163,632	24,224	17,936	10,080	6,800	4,608	3,680	5,968	10,800	435,056	
6	25,296	78,128	88,080	131,840	24,384	18,432	9,840	6,672	4,560	3,440	5,360	9,760	405,792	
7	31,984	70,672	102,096	103,744	24,240	18,112	9,792	6,592	4,608	3,472	4,864	10,176	390,352	
8	32,832	59,024	93,344	113,680	23,776	17,824	9,632	6,272	4,944	3,200	4,336	11,056	379,920	
9	36,736	53,680	93,664	115,344	22,512	17,312	9,360	5,936	5,184	3,152	3,952	12,592	379,424	
10	32,368	44,992	100,464	111,280	22,368	17,120	9,360	5,936	5,296	3,120	3,952	13,024	369,280	
11	26,160	41,200	112,176	87,776	22,576	17,056	9,024	5,936	5,344	3,120	3,952	12,336	346,656	
12	21,872	37,536	103,552	84,096	21,472	16,976	9,024	5,856	5,844	3,120	3,952	11,728	325,028	
13	21,712	32,416	98,672	79,648	20,736	15,904	9,024	5,696	6,192	3,120	4,336	10,512	307,968	
14	21,776	35,200	89,168	82,112	20,624	16,704	8,560	5,568	6,192	3,120	6,528	9,936	305,488	
15	28,832	41,360	101,104	68,192	21,200	16,368	8,480	5,488	5,920	3,120	10,544	11,232	321,840	
16	44,528	38,064	121,056	60,000	19,408	15,696	8,480	5,328	5,920	2,992	9,248	10,064	340,784	
17	52,528	36,896	122,304	58,112	18,880	14,912	8,480	5,376	5,920	2,896	9,184	8,864	344,352	
18	52,608	36,768	136,672	70,640	18,768	14,816	8,480	5,376	5,920	2,896	8,512	8,480	369,936	
19	51,008	33,552	169,968	65,584	21,072	14,080	8,304	5,248	5,920	2,784	8,784	8,224	394,528	
20	56,368	33,296	221,328	65,440	19,808	13,888	8,304	5,168	6,752	3,024	8,512	8,576	450,464	
21	64,016	40,576	234,256	63,936	19,488	13,392	8,304	5,168	6,752	3,280	9,664	8,288	477,120	
22	71,552	39,632	207,392	61,696	20,928	13,216	8,304	5,088	6,464	3,520	13,776	7,840	459,408	
23	64,384	34,512	252,144	54,192	19,552	12,896	8,128	4,960	5,856	3,840	12,752	6,992	480,208	
24	63,760	33,696	281,664	47,664	19,792	12,464	8,032	4,960	5,312	3,792	13,856	6,928	501,920	
25	61,328	37,168	268,800	43,408	20,256	12,032	7,920	4,880	5,168	3,680	15,024	6,656	486,320	
26	57,248	40,832	328,944	40,960	20,000	11,760	7,888	4,768	5,168	3,552	27,408	9,568	558,096	
27	52,272	58,352	295,856	38,448	19,776	11,616	7,888	4,624	5,168	3,472	22,112	15,152	534,736	
28	52,576	60,368	275,824	37,216	19,536	11,280	7,888	4,752	5,168	3,072	17,472	14,944	510,096	
29	51,312		266,384	34,128	19,696	11,248	7,824	4,752	5,056	3,328	24,384	21,536	449,648	
30	61,760		226,896	31,328	19,184	11,168	7,760	4,752	4,704	4,096	22,160	19,072	412,880	
31	57,232		269,248		19,296		7,600	4,704		5,392		17,664	381,136	
PROMEDIO DIARIO (L/S)													419,231	

Ilustración 110: Registro de Descarga Diaria del Año 2001

REGISTRO DE DESCARGA DIARIA														
RIO CHICAMA			AÑO 2002							ESTACIÓN EL TAMBO				TOTAL
Día	Enero	Febrero	Marzo	Abril	Mayo	Junio	Julio	Agosto	Septiembre	Octubre	Noviembre	Diciembre		
1	17,360	6,288	39,520	115,024	36,704	15,840	8,816	6,384	3,504	2,960	10,688	14,624	277,712	
2	15,328	5,744	42,400	98,544	33,888	15,520	8,752	6,592	3,504	2,928	9,520	18,912	261,632	
3	13,536	6,224	39,824	90,928	34,160	15,248	8,608	6,464	3,552	3,008	7,664	17,744	246,960	
4	12,384	10,048	38,928	77,824	32,544	15,152	8,528	6,144	3,440	3,056	6,912	15,968	230,928	
5	11,296	12,896	67,280	68,752	30,480	15,216	8,528	6,064	3,440	2,992	6,448	14,400	247,792	
6	10,304	26,816	71,456	64,720	24,608	15,344	8,448	5,824	3,520	2,960	5,840	15,520	255,360	
7	9,392	62,336	62,192	61,280	27,728	15,136	8,368	5,824	3,280	2,960	11,744	25,712	295,952	
8	8,880	35,392	66,624	94,880	26,704	15,264	8,224	5,744	3,456	3,008	11,280	31,088	310,544	
9	8,880	27,248	82,192	157,760	26,352	15,104	8,144	5,664	3,312	2,880	11,120	27,360	376,016	
10	8,272	22,720	66,720	126,960	25,840	14,528	8,064	5,488	3,232	2,928	9,904	22,960	317,616	
11	7,936	19,360	58,448	126,208	23,920	14,416	7,984	5,152	3,232	2,848	8,288	19,312	297,104	
12	8,608	17,536	65,504	143,312	22,448	14,704	7,840	5,152	3,232	2,992	8,720	16,528	316,576	
13	8,608	16,432	96,832	134,368	22,400	14,432	7,760	5,152	3,152	3,856	9,504	14,944	337,440	
14	8,368	15,904	131,136	107,872	22,400	13,936	7,680	5,152	3,072	4,304	16,992	13,808	350,624	
15	8,672	14,288	146,080	89,216	21,536	13,632	7,680	5,152	2,992	4,176	19,456	12,944	345,824	
16	8,256	13,776	110,800	79,232	20,304	13,200	7,680	4,960	3,168	4,384	16,080	12,592	294,432	
17	7,536	14,608	127,008	71,088	20,112	12,768	7,600	4,960	2,960	4,208	13,632	12,352	298,832	
18	7,312	15,584	100,880	64,768	19,232	12,736	7,600	4,880	2,928	4,304	13,632	12,160	266,016	
19	6,592	25,632	117,232	64,760	18,192	12,416	7,488	4,800	3,024	4,096	17,424	11,776	293,432	
20	6,672	32,304	128,960	55,464	17,344	11,424	7,296	4,208	3,072	4,032	20,240	11,248	302,264	
21	6,736	33,968	102,832	54,432	17,632	10,624	7,296	3,920	3,168	4,288	18,912	11,056	274,864	
22	11,072	32,096	127,520	55,072	17,440	10,352	7,104	3,984	3,072	4,272	17,984	11,696	301,664	
23	15,648	34,032	95,392	54,896	17,680	10,032	7,024	4,096	2,768	4,272	17,872	14,464	278,176	
24	12,928	35,648	79,920	58,528	18,032	9,872	7,024	4,096	2,912	4,624	15,360	20,016	268,960	
25	10,272	52,256	85,584	51,808	18,864	9,760	6,944	4,080	2,944	5,296	14,368	17,344	279,520	
26	9,648	62,960	71,248	47,328	19,456	9,600	6,944	3,952	2,896	5,728	13,360	16,544	269,664	
27	9,040	51,616	70,880	44,464	18,784	9,360	6,864	3,664	2,896	6,400	12,288	16,592	252,848	
28	8,288	42,640	92,400	45,504	18,256	9,168	6,624	3,744	2,816	9,856	10,928	21,184	271,408	
29	7,504		116,944	42,192	17,584	9,040	6,384	3,360	2,784	12,928	9,696	23,696	252,112	
30	6,608		124,464	40,416	17,120	8,880	6,384	3,280	2,784	11,552	14,944	28,544	264,976	
31	6,096		123,520		16,336		6,384	3,488		10,848		28,688	195,360	
PROMEDIO DIARIO (L/S)													284,923	

Ilustración 111: Registro de Descarga Diaria del Año 2002

REGISTRO DE DESCARGA DIARIA														
RIO CHICAMA			AÑO 2003							ESTACIÓN EL TAMBO				TOTAL
Día	Enero	Febrero	Marzo	Abril	Mayo	Junio	Julio	Agosto	Septiembre	Octubre	Noviembre	Diciembre		
1	26,720	31,808	21,152	39,872	20,608	8,928	5,216	2,784	1,744	1,280	1,312	2,240	163,664	
2	23,984	30,544	39,072	40,112	20,208	8,752	5,152	2,672	1,600	1,248	1,344	2,240	176,928	
3	20,976	44,272	43,024	36,928	18,960	8,752	5,072	2,624	1,600	1,248	1,312	3,872	188,640	
4	19,472	43,376	39,328	33,696	18,560	8,768	5,136	2,656	1,600	1,296	1,312	3,168	178,368	
5	19,120	37,952	40,288	31,024	17,712	8,608	5,024	2,512	1,600	1,200	1,312	3,952	170,304	
6	17,312	34,224	39,168	29,712	17,856	8,832	4,816	2,384	1,504	8,832	1,120	1,312	162,208	
7	16,432	31,248	37,888	27,600	17,680	8,768	4,448	2,416	1,456	1,088	1,408	3,616	154,048	
8	15,344	38,320	34,368	25,808	27,216	8,768	4,512	2,176	1,360	1,120	1,408	3,264	163,664	
9	14,896	39,632	32,304	26,672	24,016	8,688	4,704	2,096	1,360	1,120	1,408	2,240	159,136	
10	14,560	39,632	31,808	25,024	21,680	8,608	4,544	1,952	1,408	1,024	1,360	2,128	153,728	
11	13,040	38,992	30,704	26,832	19,760	8,336	4,656	1,744	1,408	1,024	1,360	1,984	149,840	
12	12,624	35,984	34,256	33,728	18,704	8,336	4,352	1,968	1,408	1,024	1,360	1,808	155,552	
13	12,624	35,664	29,584	37,984	17,872	8,128	4,064	1,968	1,472	1,216	1,280	1,664	153,520	
14	12,096	34,272	29,008	36,848	16,672	7,792	4,016	1,968	1,520	1,216	1,152	1,792	148,352	
15	11,200	30,176	37,552	36,400	15,840	7,360	3,888	1,968	1,488	1,152	1,152	1,488	149,664	
16	10,832	27,152	37,264	37,568	15,248	7,264	3,920	1,872	1,456	1,120	1,088	1,392	146,176	
17	10,528	23,456	39,328	34,672	14,304	7,008	3,824	1,728	1,552	1,152	1,088	1,312	139,952	
18	9,808	20,784	41,408	34,192	13,744	6,720	3,664	1,600	1,520	1,232	1,088	1,392	137,152	
19	9,888	19,200	44,448	32,032	13,360	6,352	3,552	1,712	1,488	1,232	1,088	1,536	135,888	
20	9,952	17,696	40,592	29,584	12,896	6,240	3,552	1,632	1,408	1,216	1,088	1,696	127,552	
21	26,568	16,832	38,048	27,808	12,592	6,032	3,344	1,584	1,344	1,152	992	1,696	137,992	
22	19,008	17,344	34,496	26,368	11,920	6,288	3,344	1,536	1,376	1,216	1,024	1,824	125,744	
23	16,112	19,120	30,672	26,992	11,616	6,480	3,344	1,536	1,472	1,296	1,024	2,896	122,560	
24	14,128	19,120	30,256	27,744	11,136	6,416	3,440	1,600	1,520	1,296	960	3,296	120,912	
25	12,560	17,856	30,704	27,008	10,208	6,480	3,440	1,856	1,520	1,264	960	3,072	116,928	
26	12,096	16,320	29,120	25,760	10,064	6,416	3,264	1,856	1,424	1,184	960	8,576	117,040	
27	13,440	15,872	27,472	25,472	9,872	6,240	3,152	1,808	1,392	1,072	1,088	16,464	123,344	
28	15,056	16,256	25,280	24,816	9,536	6,080	2,960	1,808	1,360	880	1,504	23,728	129,264	
29	17,280		24,384	22,864	9,344	5,872	2,896	1,648	1,440	800	1,504	28,784	116,816	
30	19,040		29,168	21,904	9,264	5,648	2,896	1,760	1,408	944	1,808	26,024	119,864	
31	19,040		33,040		9,456		2,944	1,648		1,040		11,280	78,448	
PROMEDIO DIARIO (L/S)													142,685	

Ilustración 112: Registro de Descarga Diaria del Año 2003

REGISTRO DE DESCARGA DIARIA														
RIO CHICAMA			AÑO 2004							ESTACIÓN EL TAMBO				TOTAL
Día	Enero	Febrero	Marzo	Abril	Mayo	Junio	Julio	Agosto	Septiembre	Octubre	Noviembre	Diciembre		
1	9,296	1,936	14,256	20,416	10,320	5,584	2,032	880	224	480	4,384	384	70,192	
2	7,600	1,232	13,120	23,232	9,680	5,344	1,952	880	160	432	4,768	384	68,784	
3	6,432	1,424	11,696	21,168	9,376	4,992	1,872	880	208	592	4,400	2,544	65,584	
4	5,408	1,424	11,296	32,384	9,376	4,544	2,096	768	224	608	4,464	2,544	75,136	
5	4,752	3,504	10,112	27,920	9,232	4,304	2,384	768	224	1,776	5,408	2,320	72,704	
6	4,304	6,688	11,168	25,904	9,488	4,144	2,384	656	192	2,848	7,488	1,968	77,232	
7	4,752	7,504	18,928	22,672	9,200	3,904	2,384	704	192	2,160	8,336	1,808	82,544	
8	5,472	13,120	24,272	21,040	9,616	3,744	2,160	656	240	1,840	11,168	1,760	95,088	
9	8,048	14,880	23,584	18,672	9,424	3,632	2,240	624	400	1,840	19,696	1,712	104,752	
10	10,304	16,832	21,728	17,872	9,072	3,632	2,240	624	240	1,680	18,240	1,776	104,240	
11	9,728	22,416	18,688	16,496	8,512	3,680	2,112	496	320	1,520	14,688	4,016	102,672	
12	8,032	23,984	17,632	18,080	8,112	3,648	2,080	496	560	1,312	15,360	3,824	103,120	
13	6,880	32,784	15,744	18,080	7,552	3,488	2,080	496	864	1,088	14,848	3,584	107,488	
14	6,016	26,768	14,160	24,896	7,152	3,408	2,080	496	864	992	13,472	3,888	104,192	
15	5,120	25,056	13,904	28,528	6,240	3,248	2,080	448	784	912	11,472	5,136	102,928	
16	4,512	26,800	12,896	30,256	5,648	2,976	2,080	384	688	752	9,056	9,536	105,584	
17	3,760	26,848	12,176	30,160	5,056	2,816	2,080	304	576	752	7,776	8,752	101,056	
18	3,312	30,640	13,440	27,632	4,800	2,784	2,080	272	496	592	6,560	7,680	100,288	
19	2,816	28,576	13,136	24,624	4,320	2,704	2,080	240	464	560	5,472	5,200	90,192	
20	2,464	27,216	14,496	22,080	4,960	2,624	1,712	208	544	592	4,736	4,640	86,272	
21	2,080	22,896	19,520	19,792	5,744	2,592	1,488	208	576	3,536	4,352	4,336	87,120	
22	1,728	19,440	32,608	17,760	5,216	2,512	1,488	208	576	3,216	4,128	4,224	93,104	
23	1,424	16,320	32,000	15,712	5,632	2,368	1,648	208	576	4,096	4,352	3,776	88,112	
24	1,136	14,208	27,296	14,864	5,328	2,368	1,088	224	576	4,208	4,128	2,976	78,400	
25	976	13,232	28,720	13,520	5,152	2,320	1,184	208	624	12,000	3,968	2,400	84,304	
26	944	13,184	34,368	12,368	4,976	2,272	1,136	208	576	8,784	3,744	2,176	84,736	
27	896	14,976	43,760	11,936	5,488	2,112	1,296	256	512	6,736	3,248	1,840	93,056	
28	1,024	14,512	35,648	11,088	5,424	1,984	1,296	192	576	4,752	3,184	1,776	81,456	
29	1,232	14,432	29,920	11,392	6,192	1,984	1,136	224	576	3,728	3,136	1,648	75,600	
30	1,552		24,752	11,056	6,320	1,984	1,088	192	576	3,296	4,240	1,648	56,704	
31	1,936		22,400		6,000		1,088	160		4,032		1,728	37,344	
PROMEDIO DIARIO (L/S)													86,451	

Ilustración 113: Registro de Descarga Diaria del Año 2004

REGISTRO DE DESCARGA DIARIA													
RIO CHICAMA			AÑO 2005						ESTACIÓN EL TAMBO				TOTAL
Día	Enero	Febrero	Marzo	Abril	Mayo	Junio	Julio	Agosto	Septiembre	Octubre	Noviembre	Diciembre	
1	6,784	6,880	18,864	49,152	14,080	3,936	2,352	992	336	240	928	480	105,024
2	6,976	6,304	21,616	51,264	13,696	3,712	2,464	880	368	352	848	480	108,960
3	7,376	5,920	22,496	51,264	14,416	3,600	2,464	880	368	240	928	608	110,560
4	7,696	5,408	39,408	43,520	14,320	3,280	2,256	1,008	368	272	928	528	118,992
5	9,584	4,432	53,440	39,024	13,776	3,408	1,936	960	368	240	704	528	128,400
6	17,280	5,072	48,624	37,408	13,040	3,552	2,032	800	400	240	576	496	129,520
7	23,440	4,896	51,504	38,608	12,368	3,360	2,032	720	400	240	624	432	138,624
8	25,248	4,624	63,808	36,304	11,568	3,328	2,032	720	400	320	784	480	149,616
9	22,576	5,168	58,560	37,392	10,928	3,920	1,696	720	400	336	816	336	142,848
10	21,120	10,752	56,112	33,792	10,448	3,616	1,584	960	384	416	720	336	140,240
11	19,808	11,312	55,616	32,848	9,872	3,584	1,824	704	400	416	752	320	137,456
12	18,784	13,200	53,728	30,720	9,168	3,616	1,840	592	400	880	832	304	134,064
13	17,808	17,536	51,008	29,216	9,056	3,584	1,712	560	384	1,744	832	288	133,728
14	19,296	31,584	55,056	27,616	8,672	3,584	1,632	560	384	1,632	848	288	151,152
15	22,928	39,744	53,264	27,536	7,664	3,616	1,424	560	384	2,032	832	272	160,256
16	25,024	30,944	55,216	25,792	7,376	3,696	1,424	384	384	3,024	768	272	154,304
17	21,104	29,712	57,936	23,296	7,280	3,648	1,424	416	384	2,512	720	256	148,688
18	18,384	28,096	58,320	21,072	7,104	3,440	1,424	448	384	1,792	800	272	141,536
19	16,032	24,880	60,176	19,680	6,720	3,136	1,488	464	304	1,280	560	784	135,504
20	13,904	22,576	50,480	18,880	6,496	3,008	1,584	464	336	2,320	560	1,200	121,808
21	12,208	22,528	51,312	18,432	6,272	2,960	1,184	464	448	896	560	992	118,256
22	10,560	27,952	42,912	19,280	6,096	2,816	1,184	464	336	1,104	800	992	114,496
23	9,296	29,232	38,224	18,640	5,776	2,720	1,184	464	432	1,104	800	736	108,608
24	8,480	27,936	36,192	17,664	5,776	2,912	1,184	464	384	1,008	800	784	103,584
25	9,392	25,280	34,960	16,880	5,520	2,864	1,184	272	384	1,008	704	2,992	101,440
26	9,824	22,416	33,344	15,808	5,184	2,880	1,184	368	384	1,200	704	6,832	100,128
27	9,648	19,376	30,528	14,800	4,912	2,832	1,184	304	384	1,296	592	10,880	96,736
28	8,816	18,864	31,072	15,808	4,624	2,368	1,184	320	352	1,360	512	13,872	99,152
29	7,856		48,848	16,192	4,416	2,512	1,024	336	384	1,088	480	13,872	97,008
30	7,568		56,528	14,896	4,272	3,152	1,024	336	336	1,008	496	18,704	108,320
31	7,200		53,296		4,128		992	336		928		15,456	82,336
PROMEDIO DIARIO (L/S)													123,269

Ilustración 114: Registro de Descarga Diaria del Año 2005

REGISTRO DE DESCARGA DIARIA														
RIO CHICAMA			AÑO 2006						ESTACIÓN EL TAMBO				TOTAL	
Día	Enero	Febrero	Marzo	Abril	Mayo	Junio	Julio	Agosto	Septiembre	Octubre	Noviembre	Diciembre		
1	5,456	25,392	78,144	92,448	31,904	10,160	5,856	3,120	2,304	1,808	1,056	5,600	263,248	
2	4,704	30,960	93,712	72,576	31,536	9,776	5,520	3,120	2,272	1,728	1,216	4,768	261,888	
3	3,952	41,152	100,480	75,760	29,168	9,776	5,392	3,040	2,064	1,728	1,280	4,768	278,560	
4	3,376	40,672	100,288	69,184	28,176	9,536	5,392	3,088	2,144	1,728	1,248	3,936	268,768	
5	2,592	54,768	83,136	75,840	27,504	9,536	5,168	2,976	2,032	1,792	1,088	3,376	269,808	
6	2,288	80,576	103,264	84,992	26,944	10,416	5,168	2,832	1,952	1,632	1,088	3,328	324,480	
7	2,080	69,488	88,368	89,680	26,048	10,416	4,784	2,832	1,952	1,456	1,152	3,168	301,424	
8	1,904	61,456	90,950	108,400	24,784	10,416	4,608	2,832	2,000	1,456	1,248	2,896	312,950	
9	1,520	59,200	114,480	99,232	24,784	11,088	4,608	2,832	2,000	1,392	1,088	2,896	325,120	
10	1,360	55,504	87,104	81,840	24,992	11,792	4,528	2,608	1,808	1,312	1,088	4,848	278,784	
11	1,456	53,824	110,768	69,232	24,048	12,176	4,432	2,768	1,808	1,216	1,024	4,640	287,392	
12	1,024	48,704	85,504	54,032	22,928	11,744	4,352	2,768	1,904	1,120	960	3,648	238,688	
13	912	46,064	168,096	54,832	22,144	11,152	4,224	2,672	2,160	1,184	1,024	3,168	317,632	
14	768	45,424	108,192	48,544	21,520	11,152	4,304	2,528	2,144	1,184	1,024	3,168	249,952	
15	688	44,432	121,920	43,440	20,432	10,464	4,064	2,528	2,256	1,184	1,088	3,040	255,536	
16	1,312	40,736	125,872	46,320	18,912	10,160	3,872	2,528	2,256	1,072	1,600	3,040	257,680	
17	3,104	36,288	123,904	38,000	17,552	9,680	3,872	2,432	2,224	1,168	1,664	2,368	242,256	
18	8,016	31,712	146,992	34,752	16,704	9,040	3,872	2,336	2,304	1,536	1,520	2,128	260,912	
19	13,328	27,248	112,416	37,840	15,984	8,368	3,616	1,888	2,256	1,488	1,472	2,448	228,352	
20	20,672	25,216	123,216	35,520	15,280	8,080	3,712	1,760	2,320	1,280	1,760	2,288	241,104	
21	17,584	23,616	115,536	36,624	14,656	7,616	3,584	1,760	2,368	1,136	2,256	2,752	229,488	
22	13,760	23,072	117,808	39,632	14,176	7,264	3,584	2,000	2,272	1,072	2,352	9,216	236,208	
23	12,672	23,616	128,848	34,016	13,888	7,264	3,440	2,480	2,080	992	1,984	18,112	249,392	
24	10,176	31,680	115,776	32,656	13,136	6,928	3,440	2,736	2,080	1,104	1,680	33,296	254,688	
25	9,584	41,600	103,296	32,832	12,544	7,024	3,280	2,416	2,160	1,104	2,112	25,488	243,440	
26	9,248	44,576	100,470	31,904	12,080	7,024	3,328	2,496	2,240	1,024	2,688	35,264	252,342	
27	8,208	61,296	95,072	30,976	11,520	6,880	3,168	2,224	2,240	1,184	3,744	29,664	256,176	
28	7,136	67,472	89,328	32,336	11,040	6,400	3,136	2,368	2,096	1,008	6,928	33,168	262,416	
29	9,360		97,536	35,216	10,640	6,032	3,232	2,304	2,000	1,008	11,488	31,280	210,096	
30	17,952		90,288	32,912	10,240	6,032	3,120	2,304	1,808	960	9,008	27,952	202,576	
31	28,800		81,872		10,432		3,120	2,304		1,008		22,224	149,760	
PROMEDIO DIARIO (L/S)													258,423	

Ilustración 115: Registro de Descarga Diaria del Año 2006

REGISTRO DE DESCARGA DIARIA														
RIO CHICAMA			AÑO 2007							ESTACIÓN EL TAMBO				TOTAL
Día	Enero	Febrero	Marzo	Abril	Mayo	Junio	Julio	Agosto	Septiembre	Octubre	Noviembre	Diciembre		
1	19,712	32,896	12,768	103,792	40,688	14,944	6,240	4,272	2,896	2,192	8,896	10,880	260,176	
2	18,720	34,432	11,536	89,888	39,104	14,912	5,808	4,160	2,896	2,144	8,896	9,552	242,048	
3	16,768	33,216	11,248	83,008	37,072	14,512	5,808	4,080	2,896	2,064	8,080	8,544	227,296	
4	15,216	31,600	10,832	83,344	33,728	13,968	5,984	4,032	2,880	1,888	6,864	7,456	217,792	
5	25,872	31,600	25,280	81,168	32,272	13,568	5,888	3,712	2,880	1,808	6,416	6,896	237,360	
6	27,408	31,136	28,848	81,040	30,640	13,392	5,760	3,600	2,688	1,760	5,776	6,176	238,224	
7	27,408	29,232	39,808	72,976	30,416	12,784	5,760	3,600	2,688	1,760	5,280	5,632	237,344	
8	24,592	26,928	54,512	80,624	29,536	12,160	5,760	3,504	2,688	1,648	5,504	5,280	252,736	
9	22,592	25,056	59,616	76,832	28,128	11,568	5,760	3,392	2,576	1,600	8,512	4,864	250,496	
10	19,968	25,728	59,104	120,944	41,440	10,848	5,552	3,200	2,400	1,600	10,704	4,416	305,904	
11	20,352	34,304	72,912	113,232	43,664	10,400	5,392	3,088	2,464	1,856	11,984	4,032	323,680	
12	36,656	35,152	83,872	105,568	35,584	10,112	5,344	2,896	2,240	2,528	12,128	3,680	335,760	
13	31,792	36,416	95,696	108,784	31,200	9,888	5,120	2,896	2,176	2,880	10,976	3,632	341,456	
14	25,648	41,952	102,544	89,888	28,976	9,728	5,152	2,864	2,272	3,040	9,168	3,552	324,784	
15	21,792	47,456	105,296	87,440	28,544	9,552	4,992	2,896	2,352	2,832	7,840	3,552	324,544	
16	18,992	44,528	86,752	76,368	27,808	9,264	4,992	2,864	2,240	2,464	7,424	3,616	287,312	
17	16,672	39,216	88,352	68,464	26,480	8,704	4,752	2,864	2,336	2,352	9,056	3,328	272,576	
18	14,832	35,008	85,952	52,032	24,416	8,432	4,752	2,800	2,304	2,064	10,176	3,440	246,208	
19	16,016	30,752	112,528	49,440	23,936	8,256	4,528	2,928	2,336	2,064	8,960	3,408	265,152	
20	38,464	27,040	100,512	45,648	24,320	8,128	4,528	2,928	2,400	2,336	7,392	3,200	266,896	
21	34,224	24,400	78,960	47,584	23,840	7,968	4,416	3,008	2,368	4,096	7,472	3,104	241,440	
22	28,192	21,536	71,936	46,576	22,848	7,568	4,416	3,008	2,224	3,824	6,864	2,880	221,872	
23	39,344	18,688	70,848	43,824	21,024	7,520	4,464	2,912	2,320	3,920	8,912	3,504	227,280	
24	33,408	18,048	70,320	43,456	19,968	7,456	4,720	2,976	2,208	6,896	11,712	4,640	225,808	
25	28,864	17,040	65,312	42,832	19,424	7,200	4,576	2,976	2,208	7,536	11,840	4,144	213,952	
26	30,720	15,584	60,128	39,984	18,720	7,248	4,384	2,976	2,304	8,576	10,928	4,160	205,712	
27	34,384	14,224	64,592	41,280	17,632	7,136	4,384	2,976	2,256	7,712	14,464	4,016	215,056	
28	33,136	13,936	61,568	41,280	16,976	6,832	4,288	2,848	2,432	7,120	14,080	4,016	208,512	
29	30,224		64,048	39,744	16,528	6,576	4,256	2,768	2,272	6,288	12,336	7,808	192,848	
30	31,040		90,976	41,344	15,936	6,464	4,352	2,768	2,256	7,296	11,280	6,832	220,544	
31	32,896		100,944		15,088		4,352	2,768		6,912		8,368	171,328	
PROMEDIO DIARIO (L/S)														251,681

Ilustración 116: Registro de Descarga Diaria del Año 2007

REGISTRO DE DESCARGA DIARIA														
RIO CHICAMA			AÑO 2008							ESTACIÓN EL TAMBO				TOTAL
Día	Enero	Febrero	Marzo	Abril	Mayo	Junio	Julio	Agosto	Septiembre	Octubre	Noviembre	Diciembre		
1	11,280	44,384	102,528	151,200	40,560	18,496	11,280	6,368	4,240	3,696	15,936	9,984	419,952	
2	17,456	37,664	98,688	149,600	36,784	18,464	10,752	6,368	4,176	3,760	18,672	13,920	416,304	
3	16,848	33,824	81,664	160,944	38,480	17,856	10,528	6,304	3,952	3,856	16,288	13,344	403,888	
4	16,448	31,696	70,768	154,928	37,600	17,664	10,304	6,304	3,856	4,032	21,616	11,920	387,136	
5	16,064	30,256	72,480	138,864	34,912	17,872	10,240	5,168	3,856	4,032	23,472	10,688	367,904	
6	14,544	27,168	63,760	134,864	33,552	17,792	10,000	5,360	3,920	4,160	21,328	9,408	345,856	
7	12,800	24,704	58,832	131,392	31,776	17,168	9,520	5,360	3,744	4,160	19,520	8,480	327,456	
8	12,720	22,944	58,688	129,280	30,416	16,160	9,392	5,456	3,456	4,016	17,456	8,032	318,016	
9	23,648	24,000	55,200	115,680	29,648	15,408	9,328	5,584	3,632	4,352	16,800	7,712	310,992	
10	30,160	28,032	50,336	108,848	29,968	15,040	8,992	5,232	3,744	4,096	15,696	7,488	307,632	
11	23,024	29,424	49,728	116,064	29,472	14,816	8,784	4,976	3,488	4,032	13,888	7,488	305,184	
12	20,064	31,072	51,904	108,576	28,672	14,816	8,784	5,248	3,696	3,712	13,296	7,664	297,504	
13	16,496	33,600	55,168	107,424	28,864	14,736	8,608	5,568	3,456	3,536	12,704	7,616	297,776	
14	14,864	35,856	56,768	100,864	28,944	14,128	8,608	5,408	3,696	3,536	12,800	7,328	292,800	
15	15,088	40,832	72,976	99,376	29,136	14,304	8,304	5,408	3,408	3,536	12,368	7,200	311,936	
16	26,704	48,336	95,008	95,856	28,944	13,728	8,176	5,216	3,248	3,472	11,392	7,280	347,360	
17	38,464	62,288	87,952	92,176	28,096	13,184	8,256	4,960	3,248	3,584	10,096	6,752	359,056	
18	43,904	69,904	87,456	74,544	26,464	13,056	8,416	4,784	3,360	3,584	8,976	6,400	350,848	
19	42,256	97,296	87,088	69,168	26,112	13,056	8,240	4,720	3,360	3,584	8,112	5,984	368,976	
20	37,744	124,320	99,920	60,032	25,936	12,800	7,920	4,496	3,488	3,632	7,344	5,488	393,120	
21	32,896	123,392	109,936	53,056	25,248	12,560	7,600	4,576	3,584	3,632	7,232	5,216	388,928	
22	31,776	175,456	119,472	44,704	24,896	12,416	7,536	4,752	3,616	3,552	7,088	4,896	440,160	
23	34,000	196,496	106,368	43,072	23,792	12,128	7,536	4,752	3,744	3,552	6,928	4,704	447,072	
24	39,568	131,184	94,176	37,984	23,312	12,336	7,360	4,688	5,376	4,112	6,928	4,528	371,552	
25	49,376	101,648	105,392	41,728	23,008	14,496	7,040	4,464	4,496	5,904	6,528	4,448	368,528	
26	66,848	101,536	107,680	39,920	22,624	13,600	7,184	4,640	4,768	5,872	6,416	4,432	385,520	
27	50,592	96,448	110,016	38,080	22,592	12,928	7,008	4,512	4,304	5,840	6,880	4,096	363,296	
28	46,560	97,440	118,320	41,792	22,128	12,256	6,832	4,352	4,304	9,312	8,864	3,728	375,888	
29	48,928	102,608	110,048	42,272	21,600	11,952	6,512	4,608	3,664	8,784	8,864	3,584	373,424	
30	48,976		106,736	40,784	20,592	11,008	6,320	4,304	3,856	10,304	9,520	3,360	265,760	
31	45,120		135,424		20,064		6,320	4,384		16,656		3,152	231,120	
PROMEDIO DIARIO (L/S)													352,934	

Ilustración 117: Registro de Descarga Diaria del Año 2008

REGISTRO DE DESCARGA DIARIA														
RIO CHICAMA			AÑO 2009						ESTACIÓN EL TAMBO				TOTAL	
Día	Enero	Febrero	Marzo	Abril	Mayo	Junio	Julio	Agosto	Septiembre	Octubre	Noviembre	Diciembre		
1	2,848	66,128	73,952	95,680	45,440	20,672	11,264	7,040	4,288	3,088	10,496	27,648	368,544	
2	3,024	63,552	62,608	92,048	43,408	20,496	10,480	7,040	4,368	2,992	9,168	23,664	342,848	
3	3,024	66,000	64,960	91,712	40,464	19,456	10,640	6,944	4,816	3,104	10,544	22,064	343,728	
4	4,640	61,008	61,648	83,024	38,320	18,608	10,384	6,864	4,672	3,056	9,648	28,944	330,816	
5	6,080	54,256	63,904	71,472	38,784	18,064	10,080	6,560	4,400	2,768	8,336	28,944	313,648	
6	5,968	43,360	66,032	60,512	38,192	17,696	10,176	6,640	4,208	2,768	7,648	26,032	289,232	
7	5,808	60,448	79,216	57,632	37,712	17,072	10,048	6,512	4,016	2,928	6,592	21,840	309,824	
8	5,840	65,760	93,616	59,440	36,960	16,336	10,128	6,304	4,016	2,928	5,456	18,368	325,152	
9	5,744	71,664	93,904	77,968	35,680	15,840	10,240	6,192	3,888	2,704	4,880	16,080	344,784	
10	7,360	72,000	88,080	78,208	34,944	15,584	10,576	5,872	3,744	2,640	4,672	13,536	337,216	
11	11,472	82,848	80,288	81,152	34,160	15,056	11,168	5,776	3,792	2,688	4,240	12,784	345,424	
12	15,968	81,824	90,000	78,688	32,432	14,192	10,848	5,888	3,792	2,640	3,552	13,280	353,104	
13	18,848	82,384	133,280	72,624	31,232	14,192	10,480	5,728	3,728	2,592	3,424	14,176	392,688	
14	38,240	110,432	129,040	66,816	29,968	14,112	10,304	5,792	3,456	2,496	3,232	13,520	427,408	
15	52,000	109,488	169,968	74,592	29,152	14,368	9,680	5,840	3,600	2,400	3,312	12,656	487,056	
16	42,944	108,864	174,400	73,088	28,016	14,368	9,520	5,552	3,744	2,336	4,192	11,360	478,384	
17	41,216	89,936	158,048	65,792	27,008	14,016	8,976	5,552	3,680	2,640	4,304	11,296	432,464	
18	56,864	72,176	148,704	59,568	28,960	13,408	8,800	5,552	3,680	2,960	4,640	12,176	417,488	
19	65,152	64,160	118,896	55,600	29,504	13,520	8,288	5,472	3,680	3,056	6,416	15,104	388,848	
20	63,968	61,824	107,168	47,536	28,128	13,328	8,240	5,296	3,488	4,000	8,576	23,504	375,056	
21	44,496	65,520	103,024	45,952	26,656	12,816	7,856	5,200	3,232	3,808	7,136	48,768	374,464	
22	39,216	66,432	98,608	46,592	25,104	12,752	7,696	5,152	3,376	3,968	6,240	51,936	367,072	
23	34,816	67,056	109,488	50,048	24,064	12,752	7,616	4,992	3,424	4,880	5,632	42,272	367,040	
24	30,176	131,376	112,928	55,232	23,136	12,752	7,792	4,944	3,360	6,800	5,728	42,192	436,416	
25	27,248	123,488	171,984	51,696	22,480	12,832	7,792	4,784	3,472	7,424	12,336	40,688	486,224	
26	24,480	109,952	177,136	58,720	22,176	12,832	7,680	4,592	3,440	9,264	14,000	39,200	483,472	
27	24,880	89,104	178,592	51,744	22,336	12,736	7,472	4,432	3,328	8,608	15,312	35,952	454,496	
28	25,024	81,664	186,208	47,184	22,176	12,432	7,392	4,368	3,488	7,648	15,552	34,832	447,968	
29	27,376		173,088	44,848	21,920	11,984	7,168	4,432	3,184	8,752	20,688	32,288	355,728	
30	52,960		141,648	45,088	21,504	11,728	7,120	4,432	3,088	8,544	29,360	29,520	354,992	
31	55,328		118,400		20,768		7,120	4,368		9,888		26,128	242,000	
PROMEDIO DIARIO (L/S)														379,793

Ilustración 118: Registro de Descarga Diaria del Año 2009

REGISTRO DE DESCARGA DIARIA													
RIO CHICAMA			AÑO 2010						ESTACIÓN EL TAMBO				TOTAL
Día	Enero	Febrero	Marzo	Abril	Mayo	Junio	Julio	Agosto	Septiembre	Octubre	Noviembre	Diciembre	
1	23,120	14,112	23,296	78,256	33,936	16,032	7,472	4,896	3,072	3,712	2,112	2,352	212,368
2	21,168	12,784	24,512	62,624	48,880	15,536	7,552	5,040	3,136	3,600	2,192	2,240	209,264
3	19,232	11,824	27,296	46,048	51,312	14,704	7,552	5,152	3,200	3,264	2,224	2,048	193,856
4	17,568	10,864	35,856	48,576	59,120	13,936	7,520	5,152	3,072	3,424	2,272	2,160	209,520
5	16,448	9,424	42,736	47,376	57,168	13,376	7,344	4,992	2,880	3,312	2,272	2,032	209,360
6	16,128	14,720	40,336	82,944	49,184	12,816	7,264	4,560	3,120	3,184	2,176	1,840	238,272
7	16,032	41,056	38,880	72,912	45,392	12,720	7,136	4,560	3,264	3,024	2,000	1,872	248,848
8	16,128	55,408	35,072	63,504	43,360	12,928	7,088	4,672	3,152	2,848	1,840	1,888	247,888
9	15,376	37,920	35,216	54,768	41,504	12,928	7,200	4,352	3,200	2,576	1,840	2,512	219,392
10	14,928	41,152	34,080	48,304	39,024	12,496	6,928	4,448	3,232	2,352	1,744	3,200	211,888
11	15,568	40,704	30,576	46,016	37,888	12,320	6,768	4,288	3,040	2,384	1,680	3,520	204,752
12	20,608	51,168	28,400	44,288	36,992	11,744	6,576	4,368	2,848	2,480	1,776	3,408	214,656
13	19,392	53,072	45,392	43,808	34,384	11,440	6,624	4,400	2,800	2,256	1,904	3,232	228,704
14	22,000	52,704	59,600	45,136	31,872	10,768	6,544	4,048	2,848	2,192	2,384	3,072	243,168
15	20,592	49,856	49,056	42,784	29,728	10,304	6,672	3,808	2,736	2,048	2,640	3,136	223,360
16	18,160	51,040	48,688	43,184	28,208	9,984	6,992	4,000	2,896	1,824	2,896	3,136	221,008
17	16,736	58,464	47,888	42,448	27,312	9,824	6,784	4,144	2,768	1,648	4,080	2,704	224,800
18	15,968	55,456	47,600	41,168	26,176	9,664	6,784	4,000	2,672	1,760	7,008	2,464	220,720
19	17,392	54,112	53,200	40,672	24,704	9,440	6,624	3,888	2,608	1,696	6,752	2,384	223,472
20	17,360	50,000	54,576	36,928	23,168	9,280	6,624	3,840	2,560	2,032	5,728	2,416	214,512
21	17,696	43,248	50,752	37,088	22,608	9,424	6,576	3,728	2,624	2,176	4,736	2,208	202,864
22	15,760	42,000	47,120	36,496	22,144	9,632	6,320	3,648	2,624	2,544	3,856	2,320	194,464
23	15,536	40,528	47,200	34,464	21,744	9,488	6,112	3,536	2,624	2,864	3,792	2,224	190,112
24	19,840	36,512	44,416	31,216	21,216	9,072	6,064	3,648	2,576	2,800	3,280	3,904	184,544
25	22,528	32,480	43,616	29,488	20,336	8,736	5,664	3,440	2,528	2,704	2,912	4,576	179,008
26	21,776	28,432	54,960	28,352	18,864	8,688	5,664	3,392	2,592	2,608	2,736	5,056	183,120
27	20,480	25,904	57,008	30,000	17,696	8,560	5,536	3,312	3,232	2,560	2,688	5,008	181,984
28	18,224	24,304	48,800	31,376	18,656	8,400	5,312	3,184	3,792	2,400	2,320	4,736	171,504
29	17,328		45,456	28,624	17,696	8,128	5,200	3,072	3,696	2,320	2,208	5,424	139,152
30	16,064		45,584	26,880	17,424	7,792	5,040	3,024	3,504	2,224	2,320	9,376	139,232
31	15,344		49,104		16,816		4,896	3,120		2,112		14,624	106,016
PROMEDIO DIARIO (L/S)													202,962

Ilustración 119: Registro de Descarga Diaria del Año 2010

REGISTRO DE DESCARGA DIARIA														
RIO CHICAMA			AÑO 2011							ESTACIÓN EL TAMBO				TOTAL
Día	Enero	Febrero	Marzo	Abril	Mayo	Junio	Julio	Agosto	Septiembre	Octubre	Noviembre	Diciembre		
1	12,384	11,376	10,432	55,904	49,040	10,416	5,168	2,896	1,520	1,296	864	2,880	164,176	
2	9,600	11,024	10,096	50,512	44,390	9,920	4,800	3,024	1,344	1,232	832	2,752	149,526	
3	8,176	10,368	9,376	65,280	42,192	9,712	4,736	2,912	1,264	1,136	912	2,752	158,816	
4	6,928	10,224	8,576	81,552	38,864	9,520	4,992	2,848	1,424	1,248	912	2,224	169,312	
5	6,016	10,160	8,288	87,264	35,232	9,520	5,120	2,768	1,408	1,136	912	2,560	170,384	
6	5,136	13,136	8,624	85,744	33,248	10,000	5,408	2,592	1,408	1,168	912	2,160	169,536	
7	4,528	17,600	11,760	88,096	30,944	10,000	5,440	2,384	1,312	1,136	992	1,792	175,984	
8	4,656	23,568	27,344	109,264	28,720	9,664	5,504	2,224	1,312	1,088	992	1,616	215,952	
9	5,088	37,232	60,352	108,176	26,912	9,104	5,056	2,064	1,312	1,104	800	1,536	258,736	
10	8,608	36,160	38,592	114,416	25,376	8,576	4,800	2,112	1,312	1,104	640	2,176	243,872	
11	8,608	34,128	28,896	99,552	23,344	7,952	4,608	2,192	1,024	1,152	736	3,168	215,360	
12	9,904	33,120	23,648	87,120	22,224	7,520	4,512	2,096	1,136	1,200	656	4,800	197,936	
13	10,352	57,184	20,448	75,328	21,168	7,232	4,384	1,840	1,360	1,488	736	6,528	208,048	
14	10,288	52,768	18,928	70,384	21,168	7,232	4,304	1,840	1,424	1,456	800	6,048	196,640	
15	11,440	43,920	17,504	64,784	21,072	6,384	4,368	1,840	1,328	1,360	880	10,592	185,472	
16	15,440	34,208	15,392	70,400	19,936	6,336	4,256	1,552	1,328	816	928	10,176	180,768	
17	16,752	27,504	13,344	62,224	18,624	5,936	4,160	1,552	1,040	5,936	912	1,472	162,928	
18	21,392	23,040	12,048	60,624	17,296	5,632	4,032	1,552	1,248	1,072	2,336	11,008	161,280	
19	40,608	21,184	11,344	56,784	16,752	5,888	4,144	1,648	1,152	992	1,920	10,832	173,248	
20	49,152	18,400	12,160	57,840	15,680	5,984	4,144	1,696	1,248	992	1,376	8,304	176,976	
21	35,168	16,192	15,104	55,616	14,480	5,824	4,192	1,616	1,248	1,040	1,376	6,944	158,800	
22	28,496	15,040	14,624	55,696	14,144	5,872	4,080	1,456	1,248	1,040	1,248	7,248	150,192	
23	22,608	13,744	18,592	54,640	13,072	5,664	3,728	1,488	1,152	1,040	1,248	11,680	148,656	
24	17,792	12,768	26,496	53,424	13,392	5,760	3,312	1,456	1,264	880	1,296	32,560	170,400	
25	15,232	11,984	26,864	49,936	12,752	5,712	3,328	1,376	1,216	1,152	2,144	24,096	155,792	
26	13,376	10,848	54,816	56,416	12,448	5,776	3,440	1,424	1,312	1,008	2,896	26,064	189,824	
27	12,064	9,984	72,320	54,736	12,064	5,520	3,408	1,520	1,312	928	2,432	25,712	202,000	
28	10,672	9,536	61,360	53,152	12,128	5,264	3,296	1,344	1,264	928	2,352	19,792	181,088	
29	9,920		46,992	54,288	12,304	5,152	3,200	1,520	1,296	928	3,568	15,664	154,832	
30	9,280		41,408	51,936	11,696	5,392	3,104	1,520	1,328	928	3,568	19,040	149,200	
31	10,048		63,088		10,752		2,896	1,520		896		19,440	108,640	
PROMEDIO DIARIO (L/S)														177,560

Ilustración 120: Registro de Descarga Diaria del Año 2011

REGISTRO DE DESCARGA DIARIA													
RIO CHICAMA			AÑO 2012						ESTACIÓN EL TAMBO				TOTAL
Día	Enero	Febrero	Marzo	Abril	Mayo	Junio	Julio	Agosto	Septiembre	Octubre	Noviembre	Diciembre	
1	17,776	54,368	47,024	68,160	42,672	18,544	9,536	4,704	2,928	2,272	7,568	13,776	289,328
2	15,552	50,992	47,968	69,504	43,728	17,904	9,024	4,736	2,848	2,272	7,872	12,576	284,976
3	16,240	50,096	47,856	54,976	42,320	17,248	9,168	4,912	2,672	2,144	9,392	11,136	268,160
4	18,288	57,536	44,176	53,424	40,336	16,432	8,880	4,752	2,768	2,032	9,216	10,816	268,656
5	18,288	56,400	45,616	53,616	37,936	15,792	8,464	4,416	2,832	2,064	9,872	9,520	264,816
6	28,656	76,272	48,864	61,120	38,016	15,376	7,920	4,240	2,608	2,096	10,768	8,480	304,416
7	28,896	123,888	51,104	61,760	37,776	15,104	7,792	4,032	2,528	1,952	12,624	7,776	355,232
8	27,648	178,160	53,024	58,608	37,872	14,704	7,792	4,192	2,560	1,616	17,312	7,344	410,832
9	55,040	160,560	50,960	57,184	37,472	14,448	7,568	4,032	2,496	1,520	25,232	6,752	423,264
10	48,800	155,504	47,968	62,000	36,976	13,968	7,872	3,952	2,496	1,600	23,584	6,048	410,768
11	42,048	175,664	45,168	63,632	34,816	13,792	7,712	3,872	2,416	1,744	20,224	6,000	417,088
12	37,568	185,120	48,688	56,176	32,560	13,440	7,536	3,696	2,464	1,648	19,392	5,824	414,112
13	33,264	151,968	46,368	54,176	30,624	12,896	7,440	3,504	2,416	1,968	18,656	5,632	368,912
14	29,440	86,800	41,760	50,544	30,384	12,128	6,960	3,440	2,112	1,968	15,632	5,632	286,800
15	41,376	66,960	39,376	58,864	29,392	11,808	6,880	3,456	2,224	2,256	13,696	5,120	281,408
16	68,240	55,136	35,952	53,904	28,480	11,616	6,800	3,456	2,144	2,352	16,656	4,720	289,456
17	61,536	52,112	34,896	48,464	27,392	11,392	6,688	3,328	2,272	2,064	18,304	4,400	272,848
18	50,512	49,568	44,496	48,000	27,104	11,168	6,416	3,440	2,288	2,224	16,400	4,240	265,856
19	51,440	49,104	59,344	48,000	26,128	10,944	6,256	3,296	2,288	2,336	13,936	3,600	276,672
20	52,352	48,192	64,896	48,336	26,464	10,864	6,176	3,584	2,064	2,336	12,144	3,280	280,688
21	43,616	47,712	84,864	50,256	26,000	10,560	6,096	3,520	2,192	3,600	11,008	3,184	292,608
22	53,344	55,072	70,128	47,664	25,792	10,480	5,904	3,392	2,064	8,512	9,792	3,456	295,600
23	48,528	55,264	84,096	51,712	28,656	10,960	5,824	3,312	2,064	9,808	8,544	3,328	312,096
24	41,088	54,944	96,048	53,792	30,192	11,200	5,696	3,392	2,288	8,528	8,016	3,024	318,208
25	33,728	54,848	111,360	48,304	29,328	10,768	5,424	3,200	2,064	8,448	7,552	3,072	318,096
26	33,152	57,936	87,184	50,304	26,848	10,608	5,104	3,344	2,192	10,640	7,728	3,168	298,208
27	31,584	59,328	80,656	47,376	25,808	11,008	4,848	3,440	2,368	8,672	8,624	3,824	287,536
28	33,568	54,320	91,904	44,976	24,992	10,768	4,992	3,296	2,208	7,584	10,336	5,248	294,192
29	36,624	51,472	86,720	44,496	23,568	10,496	4,912	3,216	2,240	6,336	13,072	8,944	292,096
30	37,888		82,792	42,672	21,696	9,856	4,784	3,216	2,272	5,488	12,528	9,440	232,632
31	43,792		71,488		20,224		4,784	3,152		6,752		15,232	165,424
PROMEDIO DIARIO (L/S)													307,774

Ilustración 121: Registro de Descarga Diaria del Año 2012

REGISTRO DE DESCARGA DIARIA													
RIO CHICAMA			AÑO 2013						ESTACIÓN EL TAMBO				TOTAL
Día	Enero	Febrero	Marzo	Abril	Mayo	Junio	Julio	Agosto	Septiembre	Octubre	Noviembre	Diciembre	
1	29,456	16,608	77,584	68,640	21,328	14,720	6,448	3,504	2,464	1,184	8,464	1,328	251,728
2	27,968	14,848	86,256	64,880	21,120	15,088	6,384	4,000	2,224	1,088	7,536	1,328	252,720
3	22,224	13,344	85,968	71,264	20,400	15,248	6,144	3,840	2,432	1,264	6,288	1,328	249,744
4	20,528	12,304	93,872	62,464	20,128	14,672	5,888	3,600	2,496	1,168	5,744	1,328	244,192
5	19,248	13,168	92,752	85,600	19,712	13,696	5,840	3,360	2,448	1,264	5,232	1,424	263,744
6	16,848	21,152	98,704	64,880	20,416	12,944	5,968	3,504	2,192	1,168	4,528	4,080	256,384
7	15,072	32,960	91,472	61,280	21,872	12,480	5,840	3,328	2,112	1,168	4,336	4,944	256,864
8	13,840	38,464	93,232	69,936	23,392	12,080	5,520	3,632	2,112	1,264	3,920	6,336	273,728
9	12,416	35,648	83,024	71,264	22,608	11,648	5,392	3,248	2,112	1,264	3,776	7,552	259,952
10	11,264	29,760	87,952	58,992	20,848	11,408	5,360	3,168	1,840	1,280	3,104	10,032	245,008
11	10,944	26,112	89,648	52,528	20,128	11,200	5,184	3,072	1,696	1,360	2,656	13,920	238,448
12	11,024	24,992	77,568	63,664	19,200	10,736	4,992	2,944	1,696	1,488	2,592	13,152	234,048
13	11,200	22,528	86,576	48,576	18,096	10,224	4,912	2,896	1,696	1,488	2,384	10,496	221,072
14	11,440	20,000	102,960	46,688	18,224	9,792	4,912	2,896	1,632	1,696	1,984	8,512	230,736
15	11,440	17,360	106,128	42,288	18,080	9,072	4,688	2,832	2,160	1,456	1,616	7,776	224,896
16	10,256	17,056	181,008	43,136	18,336	8,864	5,008	2,752	2,160	1,696	1,472	7,184	298,928
17	9,456	15,792	181,136	40,624	19,968	8,704	4,560	2,864	1,904	3,664	1,472	11,440	301,584
18	8,784	15,632	226,384	46,688	19,152	8,704	4,448	2,624	2,016	7,664	1,472	18,416	361,984
19	8,336	18,944	226,384	41,008	18,016	8,240	4,512	2,496	1,840	6,784	1,472	22,656	360,688
20	7,648	36,816	226,384	42,032	17,552	8,240	4,528	2,496	1,952	4,960	1,520	17,792	371,920
21	7,200	29,248	165,072	39,392	17,840	8,128	3,664	2,496	1,568	4,320	1,360	13,568	293,856
22	7,440	27,712	159,968	36,592	18,736	7,936	4,128	2,576	1,568	5,008	1,408	10,288	283,360
23	9,296	48,704	134,016	33,472	18,288	7,936	4,000	2,320	1,568	4,704	1,360	9,808	275,472
24	15,584	63,792	111,424	31,952	17,408	7,632	4,000	2,272	1,568	4,400	1,536	8,032	269,600
25	17,040	59,488	109,536	29,936	16,752	7,504	4,496	2,288	1,632	4,960	1,536	6,992	262,160
26	16,288	52,656	98,704	27,664	15,904	7,376	4,128	2,288	1,504	4,992	1,424	6,192	239,120
27	14,592	60,480	88,736	25,200	15,504	7,296	4,128	2,640	1,504	4,992	1,424	5,984	232,480
28	13,952	79,184	87,152	24,048	15,504	7,024	4,112	2,848	1,760	5,936	1,424	5,360	248,304
29	15,104		98,704	22,640	15,168	6,816	4,032	2,928	1,600	6,944	1,424	4,736	180,096
30	19,088		87,152	22,208	14,880	6,416	4,272	2,784	1,520	8,192	1,424	4,192	172,128
31	18,528		81,072		14,320		3,840	2,592		8,464		4,576	133,392
PROMEDIO DIARIO (L/S)													257,688

Ilustración 122: Registro de Descarga Diaria del Año 2013

REGISTRO DE DESCARGA DIARIA													
RIO CHICAMA			AÑO 2014						ESTACIÓN EL TAMBO				TOTAL
Día	Enero	Febrero	Marzo	Abril	Mayo	Junio	Julio	Agosto	Septiembre	Octubre	Noviembre	Diciembre	
1	4,272	9,568	48,016	50,688	38,448	15,360	5,136	2,976	1,232	2,480	1,872	1,584	181,632
2	4,560	10,064	51,536	44,816	34,160	14,448	5,408	3,136	1,136	2,400	1,472	1,648	174,784
3	4,800	9,280	64,224	38,448	31,248	14,240	5,584	2,848	1,232	2,080	1,424	2,000	177,408
4	4,560	9,072	69,584	34,480	33,248	13,664	5,328	3,040	1,328	1,840	1,360	2,752	180,256
5	4,560	8,480	65,552	31,616	44,272	12,928	5,424	2,800	1,232	1,680	1,248	2,624	182,416
6	4,640	7,872	66,672	29,904	33,936	12,448	5,424	2,400	1,040	1,392	1,184	4,192	171,104
7	6,464	8,176	68,608	27,392	50,304	11,904	4,416	2,464	1,040	1,200	1,472	4,976	188,416
8	9,488	8,176	76,992	25,152	42,128	11,008	4,416	2,496	800	1,280	1,424	6,704	190,064
9	10,240	8,176	85,664	23,584	48,896	10,352	4,256	2,496	848	1,120	1,296	5,696	202,624
10	9,488	8,704	76,512	22,640	65,504	10,352	4,256	1,984	880	1,552	1,424	8,208	211,504
11	9,008	9,744	69,536	22,304	58,752	9,984	4,432	1,984	880	4,400	6,176	8,208	205,408
12	9,168	11,024	67,808	22,048	54,528	9,920	4,288	1,872	672	3,616	5,904	7,648	198,496
13	14,320	22,800	63,520	20,896	45,632	9,568	4,416	2,096	704	3,616	6,752	6,448	200,768
14	13,696	20,176	55,648	19,504	40,800	9,184	4,512	2,096	704	3,296	6,032	8,960	184,608
15	12,816	15,776	52,272	19,584	36,624	8,576	3,616	2,096	752	2,864	5,568	8,960	169,504
16	12,816	13,760	46,240	20,160	35,504	8,192	3,472	2,096	928	2,064	6,304	8,016	159,552
17	13,008	12,352	41,920	20,480	32,928	8,192	3,312	2,112	1,088	2,416	8,944	6,816	153,568
18	14,144	12,000	37,968	21,280	30,528	7,696	2,880	1,904	1,856	1,888	7,760	7,376	147,280
19	16,832	11,392	36,960	20,656	29,136	7,168	2,736	2,192	1,920	1,664	7,888	10,704	149,248
20	20,992	11,008	40,864	21,184	27,488	6,800	2,736	2,096	2,000	1,568	8,368	8,896	154,000
21	19,776	13,440	39,856	19,008	25,728	6,432	2,656	2,176	2,352	1,328	6,928	7,008	146,688
22	21,728	15,552	43,232	17,808	28,592	6,112	2,656	2,352	1,856	1,248	5,568	5,648	152,352
23	18,912	20,064	63,488	17,136	27,184	5,680	2,736	2,352	2,128	1,328	4,320	5,312	170,640
24	16,560	21,248	65,904	17,648	24,960	5,760	2,736	1,968	2,432	1,424	3,184	4,480	168,304
25	18,320	33,664	69,968	20,880	23,840	5,760	2,656	1,696	2,736	1,984	2,768	3,712	187,984
26	17,600	64,336	66,656	19,776	22,272	5,632	2,656	1,696	3,056	2,224	2,128	3,792	211,824
27	15,024	66,544	62,272	23,808	21,472	5,440	2,352	1,232	3,008	2,096	2,064	4,192	209,504
28	13,760	68,272	70,528	23,680	20,048	5,440	2,208	1,328	3,056	2,224	2,064	4,752	217,360
29	12,496		66,112	37,824	18,960	5,360	2,496	1,232	3,216	2,224	1,904	4,592	156,416
30	10,784		59,168	39,056	18,032	5,280	3,040	1,232	2,672	2,096	1,744	7,792	150,896
31	9,744		53,952		16,688		3,040	1,232		1,984	1,520	14,544	102,704
PROMEDIO DIARIO (L/S)													176,042

Ilustración 123: Registro de Descarga Diaria del Año 2014

REGISTRO DE DESCARGA DIARIA													
RIO CHICAMA			AÑO 2015						ESTACIÓN EL TAMBO				TOTAL
Día	Enero	Febrero	Marzo	Abril	Mayo	Junio	Julio	Agosto	Septiembre	Octubre	Noviembre	Diciembre	
1	26,816	78,096	55,936	130,272	32,896	20,496	6,720	4,640	2,272	1,536	4,080	4,640	368,400
2	24,656	78,400	78,576	131,024	32,720	20,176	6,672	4,640	2,192	1,712	4,480	5,520	390,768
3	21,200	54,091	77,600	89,888	31,200	19,104	6,672	4,288	2,128	1,632	3,728	6,096	317,627
4	18,128	43,733	83,408	75,472	32,528	18,048	6,352	3,824	2,048	1,536	2,768	5,056	292,901
5	14,864	37,461	72,624	71,184	32,688	17,568	6,352	4,144	1,984	1,536	2,240	4,288	266,933
6	13,488	34,016	64,560	63,008	33,184	16,864	6,512	4,000	2,192	1,456	1,856	3,648	244,784
7	12,960	41,840	69,728	57,520	30,704	16,320	6,592	4,000	2,112	1,456	1,792	3,344	248,368
8	11,648	40,224	63,520	59,808	28,896	15,616	6,512	3,792	1,840	1,376	1,952	3,392	238,576
9	9,360	38,645	60,592	63,024	27,136	14,992	6,512	3,280	1,936	1,376	1,904	3,248	232,005
10	8,016	35,541	52,736	65,136	25,424	14,240	6,240	3,504	1,840	1,376	1,904	3,104	219,061
11	7,520	30,325	46,064	62,976	24,080	13,824	6,112	3,392	1,936	1,280	1,952	3,840	203,301
12	7,520	28,176	40,864	56,768	22,880	13,584	5,792	3,392	1,952	1,280	2,096	3,424	187,728
13	7,280	25,541	36,560	57,712	22,720	13,584	5,408	3,024	1,952	1,376	2,096	2,976	180,229
14	7,360	24,240	44,208	54,816	23,712	13,216	5,904	3,024	1,600	1,376	2,160	2,832	184,448
15	7,504	23,248	47,168	55,488	26,512	12,544	5,648	3,168	1,696	1,376	2,000	2,224	188,576
16	7,120	27,792	58,160	69,936	25,536	12,112	5,856	3,168	1,872	1,456	1,904	2,048	216,960
17	9,248	30,997	72,848	65,488	26,816	11,520	5,584	3,024	1,872	1,456	1,648	2,000	232,501
18	10,768	27,136	75,472	58,368	31,792	10,368	5,264	3,024	1,776	1,552	1,712	2,048	229,280
19	11,088	24,656	96,160	53,600	38,592	9,600	5,328	3,024	1,776	1,456	1,904	1,936	249,120
20	17,904	22,608	189,312	51,584	37,120	9,424	5,264	2,736	1,600	1,456	3,792	2,048	344,848
21	24,912	20,112	208,704	51,616	32,464	9,216	5,136	2,896	1,520	1,280	5,120	2,848	365,824
22	36,368	18,816	298,224	63,584	28,768	8,720	5,136	2,576	1,600	1,456	4,752	3,168	473,168
23	43,280	18,592	298,224	56,960	26,336	8,496	5,136	2,496	1,600	1,184	5,072	3,152	470,528
24	60,640	19,088	229,600	53,392	24,192	8,128	4,880	2,496	1,600	1,248	5,216	3,408	413,888
25	57,392	22,832	219,024	49,968	22,368	7,968	4,656	2,272	1,520	1,536	6,288	5,872	401,696
26	52,736	34,448	169,936	47,328	22,368	7,504	4,656	2,272	1,424	1,424	7,776	5,584	357,456
27	44,800	44,752	169,936	43,664	21,360	7,696	4,416	2,208	1,280	1,600	6,912	5,664	354,288
28	40,496	39,376	169,936	40,080	20,400	7,552	4,656	2,128	1,376	1,600	6,576	4,560	338,736
29	37,104		164,464	37,808	19,792	7,408	4,608	2,128	1,376	1,888	6,000	7,568	290,144
30	45,968		145,168	35,888	19,248	7,136	4,672	2,128	1,376	2,160	5,360	9,136	278,240
31	43,328		133,504		19,904		4,928	2,128		4,272		8,240	216,304
PROMEDIO DIARIO (L/S)													290,216

Ilustración 124: Registro de Descarga Diaria del Año 2015

REGISTRO DE DESCARGA DIARIA													
RIO CHICAMA			AÑO 2016						ESTACIÓN EL TAMBO				TOTAL
Día	Enero	Febrero	Marzo	Abril	Mayo	Junio	Julio	Agosto	Septiembre	Octubre	Noviembre	Diciembre	
1	6,064	45,008	74,048	42,512	20,112	6,832	4,144	2,256	928	848	864	400	204,016
2	7,152	39,712	71,264	46,992	19,216	6,032	3,904	2,064	1,056	576	768	384	199,120
3	5,776	34,448	67,328	55,248	18,336	5,888	3,904	2,256	976	768	608	528	196,064
4	4,960	47,904	71,904	112,496	17,728	5,840	3,584	2,256	1,056	768	608	528	269,632
5	4,224	64,640	75,088	78,464	16,784	5,616	3,488	1,920	976	1,088	736	528	253,552
6	4,640	57,184	80,640	62,816	15,520	5,616	3,776	1,920	928	1,008	608	448	235,104
7	5,888	54,400	108,448	52,832	14,752	6,400	3,776	1,984	928	1,008	608	480	251,504
8	5,600	41,120	109,808	49,888	14,064	6,752	3,648	1,920	976	928	608	480	235,792
9	5,472	34,176	82,976	49,376	13,456	6,224	3,488	1,984	976	1,280	512	480	200,400
10	4,064	36,016	71,088	48,432	13,312	6,224	3,360	1,920	864	1,184	480	480	187,424
11	3,824	31,920	63,328	48,640	13,024	5,808	3,360	1,920	816	1,088	528	560	174,816
12	3,344	28,672	59,104	53,664	12,896	5,680	3,248	1,824	752	1,008	464	720	171,376
13	3,968	30,864	53,120	48,896	12,480	5,824	3,072	1,648	816	1,088	432	480	162,688
14	3,744	28,848	48,544	46,928	12,080	5,824	3,072	1,648	752	640	400	560	153,040
15	3,040	26,256	47,632	43,248	11,312	5,600	3,072	1,568	768	768	384	528	144,176
16	2,672	22,768	43,776	41,728	10,592	5,376	2,928	1,648	768	912	400	688	134,256
17	2,384	19,136	40,608	41,952	10,592	5,280	2,928	1,648	768	832	384	768	127,280
18	2,208	17,632	36,832	38,112	9,920	4,800	2,800	1,568	768	1,056	368	1,056	117,120
19	2,208	18,816	30,896	35,568	9,248	4,576	2,704	1,392	704	1,056	320	1,168	108,656
20	2,464	16,784	28,096	33,632	8,944	4,480	2,480	1,392	576	1,056	432	1,120	101,456
21	3,536	15,200	30,976	30,064	8,432	4,448	2,480	1,392	848	1,296	432	1,712	100,816
22	5,840	14,752	27,808	27,232	8,928	4,672	2,400	1,248	928	1,168	480	1,216	96,672
23	7,056	15,184	25,744	26,288	8,832	4,480	2,320	1,248	768	1,168	480	1,024	94,592
24	5,152	19,232	26,448	25,216	8,432	3,936	2,176	1,232	848	1,328	512	4,288	98,800
25	4,656	30,544	23,920	26,048	8,352	3,952	2,176	1,328	704	1,296	464	3,664	107,104
26	3,856	52,576	21,984	26,288	8,032	3,952	2,176	1,328	704	1,056	448	3,472	125,872
27	3,856	50,640	26,224	24,848	7,920	4,384	2,256	1,424	768	1,056	464	4,272	128,112
28	3,744	67,616	31,952	22,784	7,664	4,384	1,968	1,088	768	832	432	3,296	146,528
29	4,352	102,256	32,400	23,552	7,456	4,256	1,904	864	528	960	368	2,640	181,536
30	6,720		31,136	21,952	7,280	4,256	2,496	864	848	752	400	3,856	80,560
31	10,528		46,256		7,168		2,160	928		928		3,984	71,952
PROMEDIO DIARIO (L/S)													156,775

Ilustración 125: Registro de Descarga Diaria del Año 2016

REGISTRO DE DESCARGA DIARIA														
RIO CHICAMA			AÑO 2017							ESTACIÓN EL TAMBO				TOTAL
Día	Enero	Febrero	Marzo	Abril	Mayo	Junio	Julio	Agosto	Septiembre	Octubre	Noviembre	Diciembre		
1	4,144	22,672	105,104	544,256	49,616	33,328	17,392	8,784	5,968	5,552	7,296	5,392	809,504	
2	5,600	41,648	166,016	512,256	47,456	34,096	16,624	8,624	6,000	5,488	6,144	5,232	855,184	
3	6,439	64,560	115,088	480,256	46,000	31,648	16,272	8,576	5,888	5,280	5,616	4,752	790,375	
4	5,920	68,720	101,584	384,512	44,480	32,288	15,920	8,576	5,888	5,280	5,168	4,592	682,928	
5	5,536	92,224	109,296	368,752	43,440	32,592	15,616	8,144	5,808	5,504	4,544	5,328	696,784	
6	5,136	86,592	114,480	307,712	43,712	31,184	15,344	7,600	5,888	5,888	4,032	5,600	633,168	
7	5,216	72,496	139,168	278,752	42,912	31,136	15,072	7,792	5,808	5,760	3,776	15,120	623,008	
8	5,584	61,408	139,888	216,448	44,432	29,760	14,544	7,872	5,776	5,472	3,744	17,952	552,880	
9	7,040	102,240	137,728	186,368	42,976	29,104	14,416	7,808	5,584	5,520	3,696	14,192	556,672	
10	9,424	90,720	243,440	174,512	41,424	28,688	13,936	7,456	5,328	8,288	3,408	11,840	638,464	
11	9,008	92,080	197,472	151,360	44,528	27,504	13,584	7,488	5,168	7,216	3,472	15,408	574,288	
12	8,512	79,808	178,432	119,488	48,064	26,608	13,184	7,408	5,056	6,160	3,376	12,768	508,864	
13	7,360	65,040	144,976	81,408	47,408	25,808	12,720	7,152	5,136	5,392	3,584	10,320	416,304	
14	10,656	56,976	340,224	77,696	46,784	25,200	12,720	7,056	5,136	5,232	3,552	8,912	600,144	
15	30,128	46,992	393,872	65,920	48,016	24,944	12,720	6,880	5,072	4,960	3,392	7,680	650,576	
16	33,184	52,016	488,432	56,368	49,104	23,744	12,224	6,640	5,136	5,040	3,600	6,848	742,336	
17	24,304	58,576	456,432	54,464	46,480	23,248	11,712	6,800	5,168	5,296	3,280	6,528	702,288	
18	16,960	51,664	456,432	50,560	45,376	22,080	11,632	6,720	5,168	5,552	2,976	6,464	681,584	
19	13,056	60,464	647,952	50,672	44,400	21,808	11,904	6,512	5,072	4,992	2,672	6,464	875,968	
20	11,120	48,560	647,952	53,264	43,360	21,088	11,632	6,688	5,136	4,736	2,576	6,336	862,448	
21	11,008	52,752	631,472	55,504	43,424	20,400	10,960	6,688	5,072	4,320	2,512	6,288	850,400	
22	13,040	57,808	583,472	51,696	41,584	20,816	10,640	6,576	5,072	4,016	2,656	6,336	803,712	
23	27,584	71,328	610,944	52,240	42,336	21,280	10,016	6,576	4,960	3,776	2,736	6,224	860,000	
24	33,840	70,416	594,944	57,776	40,320	20,928	9,872	6,512	4,848	4,112	2,896	6,672	853,136	
25	33,360	67,408	608,256	51,680	39,936	20,016	9,872	6,464	4,688	8,112	3,296	6,752	859,840	
26	28,464	67,184	560,256	48,528	39,888	19,376	9,792	6,464	4,528	6,512	3,808	6,352	801,152	
27	26,208	81,344	608,256	47,648	40,096	18,848	9,760	6,208	4,560	5,392	3,728	6,048	858,096	
28	24,992	92,384	608,256	52,544	36,224	18,208	9,584	6,048	4,800	4,816	4,256	5,632	867,744	
29	23,616		560,256	49,424	34,080	17,792	9,328	6,176	5,200	4,976	4,736	5,904	721,488	
30	19,728		512,256	50,656	32,656	17,568	9,040	6,368	5,376	5,504	4,592	6,496	670,240	
31	17,696		512,304		32,176		9,040	6,128		8,256		7,568	593,168	
PROMEDIO DIARIO (L/S)													715,895	

Ilustración 126: Registro de Descarga Diaria del Año 2017

REGISTRO DE DESCARGA DIARIA														
RIO CHICAMA			AÑO 2018							ESTACIÓN EL TAMBO				TOTAL
Día	Enero	Febrero	Marzo	Abril	Mayo	Junio	Julio	Agosto	Septiembre	Octubre	Noviembre	Diciembre		
1	6,672	12,336	24,576	53,808	30,224	20,064	6,896	3,904	2,528	1,648	1,344	2,848	166,848	
2	6,352	11,424	24,080	46,432	29,232	19,104	6,784	4,064	2,528	1,648	2,560	2,928	157,136	
3	5,856	11,072	26,816	45,328	27,728	18,144	6,656	3,824	2,448	1,744	2,720	2,736	155,072	
4	5,440	10,496	37,184	54,512	25,344	18,000	6,800	4,304	2,576	1,648	3,904	2,624	172,832	
5	5,072	9,968	45,328	55,248	24,384	17,664	6,608	4,176	2,656	1,840	3,904	2,160	179,008	
6	4,832	9,056	42,736	67,664	24,704	16,672	6,432	4,176	2,800	1,840	3,504	1,728	186,144	
7	4,992	8,864	43,920	56,400	23,616	15,632	6,144	4,176	2,432	1,840	3,008	1,728	172,752	
8	6,496	9,392	38,976	53,632	27,568	14,576	5,968	4,176	2,400	1,568	2,880	1,648	169,280	
9	7,552	9,792	34,928	62,368	28,496	13,680	5,776	4,256	2,400	1,744	2,720	1,552	175,264	
10	7,024	11,616	31,584	86,288	34,928	13,104	5,728	3,952	2,400	1,744	2,352	1,552	202,272	
11	10,336	14,416	29,392	64,304	32,848	12,752	5,728	3,664	2,256	1,776	2,432	1,552	181,456	
12	14,272	14,336	27,248	58,432	32,096	12,432	5,600	3,664	2,112	1,552	2,992	1,648	176,384	
13	14,288	12,688	23,776	57,248	29,712	11,936	5,440	4,352	2,112	1,632	2,816	1,696	167,696	
14	18,240	12,224	23,376	57,984	27,600	11,936	5,456	3,776	2,112	1,712	2,608	1,744	168,768	
15	16,960	12,608	23,376	56,240	28,432	11,408	5,168	3,616	2,032	1,712	2,128	1,664	165,344	
16	15,808	22,736	23,296	50,256	28,720	10,768	5,056	3,616	2,032	1,712	1,904	1,760	167,664	
17	15,952	58,208	25,056	44,848	27,232	10,352	5,008	3,616	2,032	1,712	2,000	2,336	198,352	
18	26,784	57,344	29,424	39,536	28,512	10,416	5,056	3,456	1,936	1,712	1,680	2,992	208,848	
19	41,888	60,208	33,248	37,360	30,912	10,272	5,008	3,456	2,032	1,712	2,352	7,088	235,536	
20	46,448	71,232	47,776	38,208	31,696	9,920	5,008	3,120	2,512	1,712	2,656	10,032	270,320	
21	36,448	51,536	42,960	36,352	27,824	9,232	5,008	3,104	2,384	1,888	6,368	15,408	238,512	
22	28,864	43,536	58,320	34,096	27,872	8,752	4,736	3,104	2,272	2,128	8,880	20,048	242,608	
23	28,688	36,768	64,528	32,336	30,192	8,368	4,608	3,104	2,112	2,608	8,736	31,424	253,472	
24	26,784	34,064	84,176	30,912	27,904	8,208	4,608	3,072	2,112	2,608	7,344	22,192	253,984	
25	23,104	30,464	81,376	30,752	26,352	7,888	4,528	3,072	2,224	2,464	5,936	17,824	235,984	
26	20,016	27,136	57,792	30,928	25,872	7,888	4,880	3,008	2,112	2,336	5,152	14,272	201,392	
27	18,272	24,576	65,728	30,464	25,088	7,888	4,560	2,960	2,000	2,272	4,544	11,664	200,016	
28	16,592	25,072	67,072	27,792	22,992	7,728	4,560	2,576	2,000	1,376	4,224	10,432	192,416	
29	14,800		62,144	37,392	22,992	7,600	4,560	2,656	1,920	1,424	3,872	8,912	168,272	
30	13,984		61,520	31,008	21,936	7,168	4,176	2,592	1,840	1,424	3,696	7,968	157,312	
31	13,232		61,776		20,784		4,064	2,528		1,376		7,008	110,768	
PROMEDIO DIARIO (L/S)													191,346	

Ilustración 127: Registro de Descarga Diaria del Año 2018